

K - S T A T I O N



K-Station

polyphonic synthesizer

▲ User Manual

Copyright: Novation E.M.S Limited 2002 K-Station User Guide Version 1.1a

Features and specifications subject to change without notice due to improvements

www.novationmusic.com

Introduction.....	2	Advanced Features.....	23
Using this Manual.....	2	Oscillator Menu.....	23
Main Features.....	2	Filter Menu.....	25
Conventions used in this Manual.....	2	LFOs Menu.....	25
		Envelopes Menu.....	26
Quick Start Guide.....	3	Effects Menus.....	28
Connecting to audio and MIDI equipment.....	3	Delay menu.....	28
Listening to the factory preset sounds.....	3	Reverb Menu.....	29
Selecting Sounds.....	3	Chorus Menu.....	29
Editing a sound.....	4	Distortion Menu.....	30
Saving a sound.....	4	EQ Menu.....	31
Listening to the factory demonstration.....	4	Panning Menu.....	32
		Vocoder Menu.....	33
		Utilities Menu.....	33
Synthesis Tutorial.....	5	Global Menu.....	35
Elements of a sound.....	5	Wheels Menu.....	37
Oscillators and waveforms.....	5	Aftertouch & Breath Menu.....	37
The Mixer.....	6	Arpeggiator Menu.....	38
The Filter.....	7	Advanced Connection Diagram.....	39
Envelopes and Amplifier.....	8	Factory Preset Sounds Listing.....	40
LFOs.....	9		
Memories.....	9	Appendix.....	A-1
Summary.....	9	Technical Specification.....	A-1
		MIDI Controller List.....	A-2
MIDI Tutorial.....	10	MIDI NRPN List.....	A-4
About MIDI.....	10	Packed Controller / NRPN Details.....	A-5
MIDI messages used by the K-Station.....	10	MIDI System Exclusive Messages.....	A-6
MIDI and Sequencers.....	12	MIDI Implementation Chart.....	A-12
Summary.....	12		
		Index.....	I-1
Main Features and Operation.....	13		
Front Panel Layout.....	13		
Modes and Menus.....	14		
Oscillator Section.....	15		
Mixer Section.....	16		
Filter Section.....	17		
LFO Section.....	18		
Envelopes Section.....	18		
Volume and Keyboard Octave Controls.....	19		
Arpeggiator Section.....	19		
Effects Section.....	20		
Display and Data Entry Section.....	21		
Mode and Keypad Section.....	22		

Using this Manual - Main Features - Conventions used in this Manual

Thank you for purchasing the Novation K-Station Synthesizer.

This instrument is a keyboard version of the popular A-Station sound module. The design of the K-Station has evolved from the classic Novation Bass Station, using the very latest award winning Novation technology as found in acclaimed products such as the Nova and SuperNova II. The K-Station is capable of producing an enormous range of high quality synthesized sounds and is an ideal machine for a home studio set-up or for an experienced producer looking to add an extra dimension of controllable sound power.

Using this Manual

This manual consists of six chapters, **Introduction, Quick Start Guide, Synthesis Tutorial, MIDI Tutorial, Main Features and Operation, and Advanced Features**. For easy reference, the chapter name is printed in the footer margin of each page. An **Appendix** on the final pages lists factory preset sounds, MIDI controllers and MIDI implementation chart.

In order to become an expert user as quickly as possible, it is recommended that this manual is read in sequence chapter by chapter. If sound synthesis is an unfamiliar subject, then the chapter **Synthesis Tutorial** will provide a useful introduction to the techniques used to electronically simulate the sound of a musical instrument using an analogue music synthesizer.

Another chapter, **MIDI Tutorial** provides a useful introduction to the subject of MIDI and how it is used for communication between instruments and / or sequencers. The chapter also describes how the K-Station transmits and recognizes various types of MIDI messages.

If the general principles of Sound Synthesis and MIDI are already familiar, then the Quick Start Guide is the place to begin. Once familiar with the main features of the machine, the Advanced Features section covers the Effects, Arpeggiator, Synchronization, Triggering and the Utilities, and will provide all of the information needed to operate the K-Station in the most creative, productive way.

Have fun !

Main Features

* **Four hundred Program sound locations**

Two hundred factory programmed sounds are included and a further two hundred user sound memory locations are provided (the two hundred factory sounds may be overwritten).

* **Powerful Oscillators**

Three Oscillators provide Sawtooth, Square, Variable Pulse, Triangle and Sine waves. The Sawtooth, Triangle and Sine waveforms may be duplicated within an Oscillator to provide thicker sounding waveforms. Synchronization and FM between two Oscillators allow the generation of metallic or percussive timbres. A white noise source completes the waveform engine.

* **External Audio Input**

The Mixer allows an external audio signal to be combined with the Oscillators and processed through the Filter and Envelopes. Envelopes may also be auto-triggered by an external signal.

* **Filter**

The filter in the K-Station Synthesizer delivers the liquid sound of an analogue filter. Selectable Low-pass, 12dB or 24dB cut-off curves with Resonance, Overdrive and Resonance normalize make it easy to faithfully recreate anything from distorted rave screams to tightly rounded bass patches.

* **Vocoder**

The 12 band Vocoder makes it easy to create Robot and Talky sound effects.

* **Arpeggiator**

The arpeggiator features six different pattern types with adjustable gate time for staccato effects.

* **Comprehensive MIDI control specification**

Adjustments of any controls transmit MIDI Controller numbers or NRPNs for real time recording by a sequencer or computer.

* **Powerful Effects**

The effects processor includes Distortion, Stereo Chorus, Phaser, Reverb, Synchronized Delay and Synchronized Stereo Panning. Complex, dynamic timbres may be created using tempo synchronized effects settings. A final output EQ and Filter section complete with a tempo synchronized LFO allow for a performance to be automatically filtered and time locked from 32nd triplets through to several bars.

* **Data Compatibility**

The K-Station has been designed to be totally data compatible with the Novation A-Station. This ensures that existing sound libraries and global settings can easily be transferred between the two types of machine.

Conventions used in this Manual

The word 'Program' refers to a collection of knob and switch settings that define an individual 'Sound'. These settings are then saved as a 'Program' that has a corresponding number in the machines non volatile memory.

Throughout this manual the two words, 'Sound' and 'Program' are frequently referred to and essentially have the same meaning.

The word 'Preset' refers to a Program which was set up at the factory to showcase some of the K-Station's powerful sound possibilities. Preset memories may actually be overwritten with new sounds, but it is possible to restore them to the original factory set sounds if they have been overwritten by mistake.

Text in CAPITALS refers to a front panel control or legend (even though the name of the control may actually be in lower case on the front panel). It could be a knob or button. For example, FREQUENCY refers to the Filter frequency control knob. MENU refers to the Menu Mode button.

The fastest way to become familiar with the K-Station is to follow this quick start guide. It covers connecting up the K-Station, listening to the factory preset sounds, selecting sounds, editing a sound and saving a sound into a memory location.

Connecting to audio and MIDI equipment

Before connecting the K-Station to other units in the system, ensure the power to all units is off. Connect an audio cable from the Left and Right master output sockets to a suitable amplifier or mixing desk stereo inputs. If the K-Station is to be operated in MONO, either output may be used.

Connect the power supply (Novation PSU-6) to the socket 'Power In 9VDC' and connect the adapter to the AC mains. Switch on the power. The K-Station's display will enter **Program mode** and show a Program number.

Finally, switch on the other units in the Audio system (amplifier, mixer etc.).

Although the K-Station has its own keyboard which would normally be used to trigger the internal sounds, it is still possible to play the K-Station by connecting an external master keyboard if desired. If it is desired to use an external master keyboard or sequencer/computer, please refer to the advanced set up diagram illustrated on Page 39.

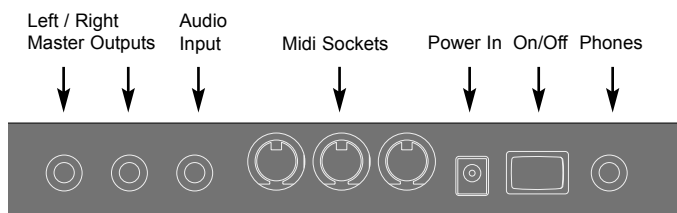

Rear Panel

Listening to the factory preset sounds

Set the VOLUME control to a reasonably high output level. This will maintain a good signal to noise ratio. Make sure that the input volume setting on the system amplifier or mixer is initially set to zero.

The K-Station is initially set when it leaves the factory to receive on MIDI channel 1, so if using an external master keyboard or sequencer to trigger the K-Station, ensure that it is set to transmit on this channel. Playing the K-Station's own keyboard, master keyboard or sequencer will result in the currently selected factory preset sound being heard.

A complete listing of the factory preset sounds is on Page 40. The first few locations of the user memory - sounds 300 - 305 contain initialisation examples. The descriptions these examples is also on Page 40.

Selecting Sounds

There are four ways to step through the factory preset sounds.

In the K-Station, sounds are organized into 4 banks, each bank containing 100 sounds. These are referred to as Banks 1, 2, 3 and 4.

- Bank 1 100 - 199 - First bank of factory preset sounds
- Bank 2 200 - 299 - Second bank of factory preset sounds
- Bank 3 300 - 399 - First bank of user sounds*
- Bank 4 400 - 499 - Second bank of user sounds

1 - Using the 0 - 9 Keypad buttons

Ensure that Menu Mode is not active (the LED above the MENUS button must not be flashing). If the K-Station is already in Menu Mode, simply press the MENUS button again to cancel Menu Mode.

There must always be a three digit entry on the numeric keypad, for example : To select Bank 1 sound 8, press the **1**, **0** and **8** buttons. The display will indicate that **Program 108** has been selected.

Provided the K-Station is not currently within a menu, the keypad buttons may be used to select a new Program at any time.

2 - Using the PAGE buttons

Ensure the K-Station is in **Program Select Mode** by pressing the PROGRAM button. The display will show the text 'Program' along with the current Program number.

The PAGE buttons may now be used to move up or down to the next Program. Pressing and holding either button for a short period will cause the Program number to advance / decrease by a further 9 and then auto increment + or - 10 steps. This is useful for auditioning factory preset sounds that are set ten locations apart. For example Bass type sounds are at 100, 110, 120 etc.

3 - Using the DATA knob

Ensure the K-Station is in Program Select Mode by pressing the PROGRAM button. The display will show the text 'Program' along with the current Program number.

The DATA knob may be used to move up or down to the next Program. Turning the knob slowly will advance the current selection by one Program. Moving the knob more quickly will increase the number of Programs advanced. Once the end of a Program bank has been reached, the first Program of the next bank will automatically be selected.

4 - Using MIDI Program Change Commands

A MIDI Program change message sent from an external sequencer or controller keyboard will instantly select the appropriate Program within the currently selected Program bank.

A MIDI Bank Change message (CC32) received along with a Program change message will select the appropriate Program within the bank specified by the Bank Change message.

If Bank Change messages are used, it is recommended that the Bank Change message is sent *immediately* before the following Program Change. A Bank Change data value of 001 is used to select Bank 1, a data value of 002 is used to select Bank 2 etc.

Whenever a new Program is selected on the K-Station, both Bank Change and Program Change are transmitted via MIDI Out.

Note that the K-Station does not have to be in Program Select Mode to respond to these MIDI messages. They can be received at any time.

Editing a sound

Once familiar with the sounds that are available, select Program number 499. This is a very basic synthesizer sound which can be used as a starting point to create a new, more interesting sound for your own use.

When this sound is played from the keyboard, it will be noticed that the volume of the sound instantly reaches its maximum level when a key is pressed, and dies away instantaneously as soon as the key is released. The most useful editing controls on the K-Station are found on the front panel and some of these will be now be used to modify (edit) this basic program.

While playing the keyboard, adjust the Amplifier Envelope SUSTAIN control. Notice how that the sound level when holding a key down changes. Set this control to just over half. Now adjust the RELEASE control. Notice how, when a key on the keyboard is released the sound will now gradually die away.

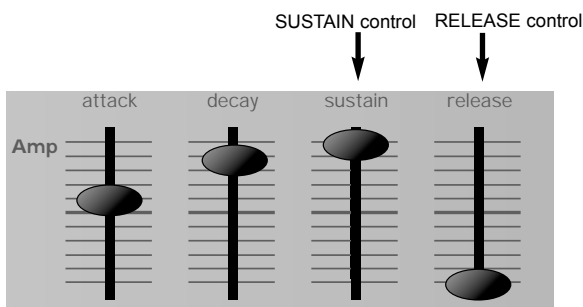

How quickly the sound dies away depends on the setting of this control. The sound is still a little too bright. Adjust the FREQUENCY control in the filter area. Notice how the sound becomes softer as the control is rotated anticlockwise. Continue to make adjustments until a desired sound is heard. The first small edit is now complete on the K-Station!

The edited sound must now be saved into a memory location if it is to be needed for the future.

Saving a sound

Sounds may be saved in any memory location. However, it is recommended that the user locations (Banks 3 and 4, 300 - 499) are used early on for saving new sound creations. The factory preset sounds in Banks 1 and 2 may also be overwritten if desired. Once these factory presets are overwritten, they may only be retrieved by performing a factory restore - See Page 33 (A backup of the factory preset or user programs, either one by one or by bank may be made to an external MIDI sequencer - Also see Page 33).

NOTE: When the K-Station is shipped from the factory, the global memory protect switch is set to on. The memory protect switch is a safety feature designed to prevent memories from being overwritten by accident. Therefore, in order to save a sound, the global memory protect must be switched off.

If an attempt is made to save to a memory while the global memory protect is still switched on, the K-Station will display a brief warning message. No data will have been written to memory.

Switching off Global Memory Protect

Press the MENUS button. The LED above the MENUS button will now light, indicating that the K-Station is in **Menu Mode**. Select the Global Menu by pressing the '7' button on the 0 - 9 numeric keypad. If necessary, use the PAGE buttons (immediately to the left of the display window) to scroll up and down the pages within the menu until the display shows **Mem Protect** and its current setting (**ON** or **OFF**). Use the DATA knob to turn memory protect **OFF**.

Note: To make permanent (held even when power is off) any changes to the K-Station's global settings, See Page 35.

Exit Menu Mode either by pressing the MENUS button again or by pressing the PROGRAM button. (the LED above the MENUS button extinguish, indicating that the K-Station is no longer in Menu Mode).

To save a Program to the same location

Press the WRITE button. The display will now show the current Program number and the destination memory number where the Program is about to be saved to. In this example, **Write to 499 ?** Notice that the destination memory is always initially set to the currently selected Program's number.

Press the WRITE button again. **Overwrite 499 ?** will be displayed. It is possible to abandon the save procedure at any point by pressing the PROGRAM button. The K-Station will return to Program Select Mode without saving the Program to memory.

To proceed with the saving procedure, finally press the WRITE button again. This saves the edited Program to memory and once the sound has been written, the K-Station will return to **Program Select Mode**.

To save a Program in a different location

Press the WRITE button. The display will now show the current Program number and the destination memory number where the Program is about to be saved to. In this example, **Write to 499 ?** Notice that the destination memory is always initially set to the currently selected Program's number.

The destination memory may now be selected by using the KEYPAD buttons, DATA knob or PAGE buttons in a similar manner as when selecting sounds in Program Select Mode. - In this example select **498**

Press the WRITE button again. **Overwrite 498 ?** will be displayed. It is possible to abandon the save procedure at any point by pressing the PROGRAM button. The K-Station will return to Program Select Mode without saving the Program to memory.

To proceed with the saving procedure, finally press the WRITE button again. This saves the edited Program to memory and once the sound has been written, the K-Station will return to **Program Select Mode**.

Using the Compare Function

After editing a sound it may be useful to compare it to the originally stored program.

To illustrate this, select Program 498 (if not already selected) and adjust the filter FREQUENCY control knob in the filter section until the sound is less bright.

Press and hold down the COMPARE button. The sound being listened to will now be the originally stored program. Notice in this example how the sound is now bright again. Releasing the COMPARE button will switch to listening to the edited (less bright) sound again.

Listening to the factory demonstration

To complete this Quick Start Guide section, some time spent listening to the sounds that the K-Station is capable of producing will be of benefit when it comes to creating new sounds.

Press the MENUS button - the LED above the button will light. Simultaneously press the both the keypad 1(osc's) and 2(filter) buttons. The Factory demonstration will begin to play. Once the demonstration has finished, the K-Station will enter **Program Select Mode**.

It is also possible to stop the demonstration at any time while it is playing by pressing the PROGRAM button to return immediately to **Program Select Mode**.

It is recommended that this chapter is read carefully if Analogue sound synthesis is an unfamiliar subject. Users familiar with this subject can skip this chapter and move on to the chapter - **MIDI Tutorial** on Page 10.

Elements of a sound

To gain an understanding of how a Synthesizer generates sound it is helpful to have an understanding of the components that make up a sound, be it musical or non musical.

The only way that a sound may be detected is by air vibrating the eardrum in a regular, periodic manner. The brain interprets these vibrations (very accurately) into one of an infinite number of different types of sound.

Remarkably, *any sound* may be described by just *three terms*, and all sounds *always** have them. They are :

- * Volume
- * Pitch
- * Tone

What makes one sound different to another is the proportion of these three qualities initially present in the sound and how these three terms *change* throughout the duration of the sound.

With a musical synthesizer we deliberately set out to have precise control over these three terms and, in particular, how they can be changed throughout the duration of the sound. These terms are often given different names, Volume is referred to as Amplitude, Pitch as Frequency and Tone as Timbre.

Pitch

Taking the example of air vibrating the ear drum, the pitch is determined by how fast the vibrations are. For an adult human the lowest vibration perceived as sound is about twenty times a second, which the brain interprets as a bass type sound, and the highest is many thousands of times a second, which the brain interprets as an extreme treble type sound.

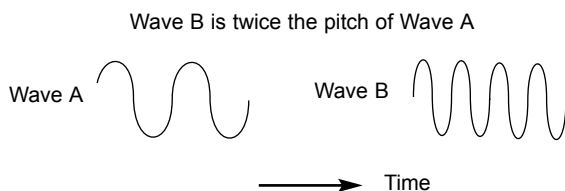

If the number of peaks in the two waveforms (vibrations) are counted, it will be seen that there are exactly twice as many peaks in Wave B as in Wave A. (Wave B is actually an octave higher in pitch than Wave A). It is the number of vibrations in a given period that determines the pitch of a sound. This is the reason that pitch is sometimes referred to as frequency. It is the frequency of the waveform peaks which are counted during a given period of time.

Tone

Musical sounds consist of several different related pitches occurring simultaneously. The loudest is referred to as the 'Fundamental' pitch and corresponds to the perceived note of the sound. Pitches related to the fundamental are called harmonics. The relative loudness of these harmonics compared to the loudness of all the other harmonics (including the fundamental) determines the tone or 'Timbre' of the sound.

Consider two instruments such as a harpsichord and a piano playing the same note on the keyboard and at equal volume. Despite having the same volume and pitch, the instruments would still sound distinctly different. This is because the harmonics present in a piano sound are different to those found in a harpsichord sound.

Volume

Volume, which is referred to as the amplitude or loudness of the sound is determined by how large the vibrations are. Very simply, listening to a piano from a metre away would sound louder than if it were fifty metres away.

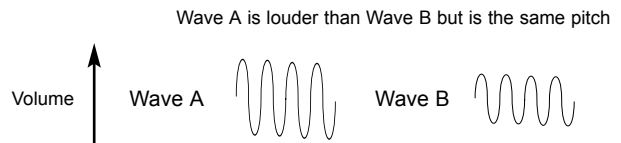

Having shown that just three elements make up any sound, these elements now have to be related to a Musical synthesizer. It is logical that a different section of the Synthesizer 'Synthesizes' (or creates) these different elements.

One section of the synthesizer, the **Oscillators**, can generate multiple waveforms which provide the pitch of the sound along with its raw harmonic content (tone). These waveforms may be mixed together in a section called the **Mixer**. The mixed signal is then fed into a section named the **Filter** which is responsible for further altering the tone of the sound. It does this by removing (filtering) certain undesired harmonic frequencies. Lastly, the filtered signal is fed into a final section, the **Amplifier** which determines the final volume of the sound.

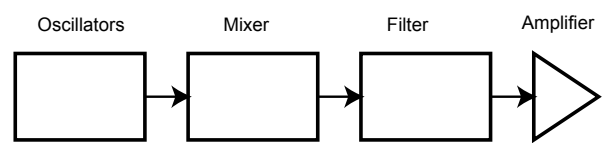

Audio path of the main Synthesizer blocks

Additional synthesizer sections; **LFOs** and **Envelopes** provide ways of altering the pitch, tone and volume of a sound by interacting with the **Oscillators**, **Filter** and **Amplifier**. They introduce changes in the character of a sound that evolve throughout the duration of the sound. Because the **LFOs** and **Envelopes** only purpose is to control (modulate) the other synthesizer sections, they are commonly known as 'modulators'.

These various synthesizer sections will now be covered in more detail.

Oscillators and waveforms

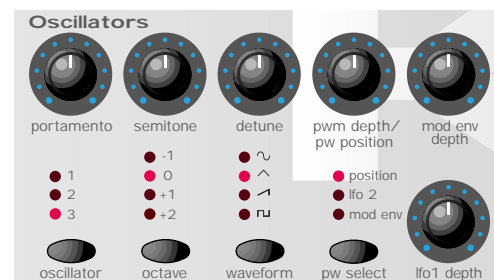

The Oscillator is really the heartbeat of the Synthesizer. It generates an electronic wave (which creates the vibrations). This *Waveform* is produced at a controllable musical pitch, initially determined by the note played on the K-Station keyboard or a received MIDI note message. The initial distinctive tone or timbre of the waveform is actually determined by the wave's shape.

Many years ago, pioneers of musical synthesis discovered that just a few distinctive waves contained most of the useful harmonics for musical synthesis. The names of these waves reflect their actual shape when viewed on an instrument known as an *Oscilloscope*, and are known as, Sine waves, Square waves, Sawtooth waves, Triangle waves and Noise Waves.

Each one has a specific fixed amount of musically related harmonics (except noise waves) which can be manipulated by further sections of the Synthesizer.

*Noise is a special case since it contains all frequencies.

Oscillators and Waveforms - The Mixer

The diagrams below show how these waveforms look on an Oscilloscope and illustrate the relative levels of their harmonics. Remember, it is the relative levels of the various harmonics present in a waveform which determine the tone of the final sound.

In summary, the Oscillators generate *Waveforms* at a controllable pitch. These Waveforms determine the initial character (Timbre) of the sound.

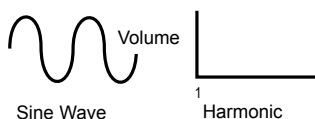

Sine waves

These have just a single frequency. This waveform produces the purest sound because it only has this single pitch (frequency).

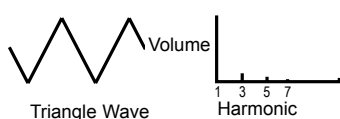

Triangle waves

These contain only odd harmonics. The volume of each is the inverse square of its position in the harmonic series. For example, the 5th harmonic has a volume of 1/25th of the fundamental.

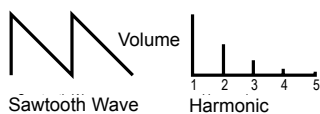

Sawtooth waves

These have a rich proportion of harmonics, containing all the harmonics of the fundamental frequency. The volume of each harmonic is inversely proportional to its position in the harmonic series.

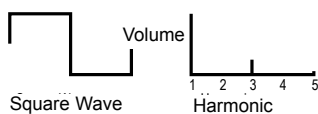

Square waves

These only have only the odd harmonics present. These are at the same volume as the odd harmonics in a sawtooth wave.

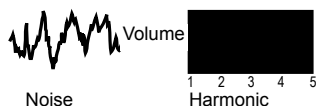

Noise waves

These have no fundamental frequency (and therefore no pitched element). All frequencies are at the same volume. Because they have no perceivable pitch, noise waves are often useful for creating sound effects and percussion type sounds.

The Mixer

To extend the range of sounds that may be reproduced, a typical Analogue synthesizer often has more than one Oscillator. By using more than one Oscillator when creating a sound, it possible to achieve very interesting harmonic mixes. It is also possible to slightly detune individual Oscillators against each other which creates a very warm 'fat' sound. The K-Station has three independent Oscillators and a separate Noise Oscillator.



For flexibility, a mixer section is included so that the amplitude (volume level) of each of the Oscillators may be adjusted independently and mixed together to form a harmonically complex waveform.

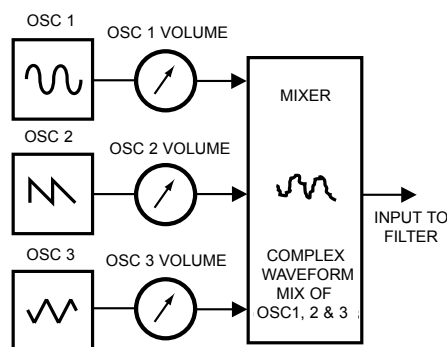

As well as mixing together the individual Oscillators as shown in the diagram above, the mixer section of the K-Station also allows the relative volume levels of the Noise Oscillator, Ring Mod and any external sound source to be set.

The Filter

The K-Station is an *Analogue subtractive* type of music synthesizer. *Subtractive* implies that part of the sound is subtracted somewhere in the synthesis process.

The Oscillators provide the raw waveforms with plenty of harmonic content and it is the *Filter* that subtracts unwanted harmonics in a controllable manner.

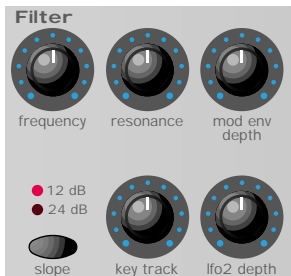

The Filter in the K-Station is a Low Pass type. A cut-off point is chosen and any frequencies below that point are passed and any above are filtered out. The setting of the FREQUENCY knob on the K-Station panel dictates the point below which frequencies are removed. This process of removing harmonics from the waveforms has the effect of changing the sounds character or timbre. When the FREQUENCY knob is set fully clockwise, the filter is set completely open and no frequencies are removed from the raw Oscillator waveforms.

In practice, there is a gradual reduction in the volume of the harmonics above the cut-off point. How quickly these harmonics are reduced in volume above the cut-off frequency is determined by the Filter's slope. This slope is measured in 'volume units per octave'. Since Volume is measured in decibels, this slope is quoted in number of decibels per octave (dB). Typical values are 12dB or 24dB per Octave. The higher the number, the faster the harmonics are cut and the more pronounced the filtering effect.

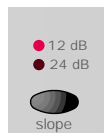

The button on the K-Station's front panel marked SLOPE allows either the 12dB or 24dB type filter slope to be selected.



A further important feature of the Filter is the RESONANCE control. Frequencies at the cut-off point may be increased in volume by this control. This is useful for emphasizing certain harmonics of the sound.

As the RESONANCE is increased, a whistling like quality will be introduced to the sound passing through the filter. When set to very high levels, RESONANCE actually causes the filter to self - oscillate whenever a signal is being passed through it. The resulting whistling tone being produced is actually a pure sine wave, the pitch of which depends on the setting of the FREQUENCY knob (the filter's cut-off point). This resonance-produced sine wave can actually be used for some sounds as an additional sound source if desired.

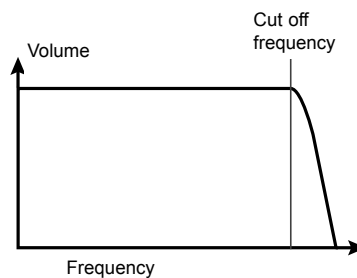

This diagram shows the response of a typical low pass filter. Frequencies above the cut off point are reduced in volume.

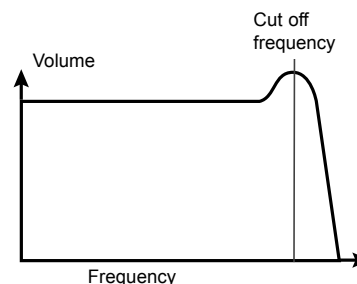

When resonance is added, frequencies at the cut off point are boosted in volume.

Envelopes and Amplifier

In earlier paragraphs, it was determined how the pitch and timbre of a sound is synthesized. This final part of the Synthesis Tutorial describes how the volume of sound is controlled. The volume throughout the duration of a sound created by a musical instrument often varies greatly according to the type of instrument.

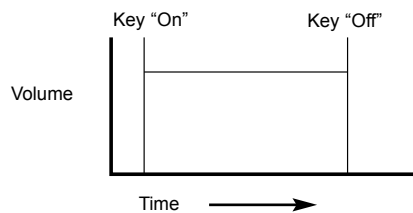

An Organ sound quickly attains full volume when a key on the keyboard is pressed. It stays at full volume until the key is released, at which point the volume level falls instantly to zero.

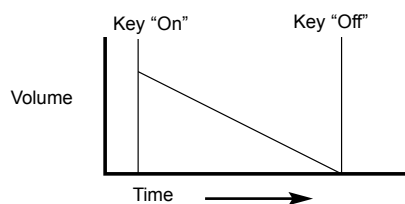

A Piano quickly attains full volume when a key is pressed and gradually falls back down to zero after several seconds, even if a key is held.

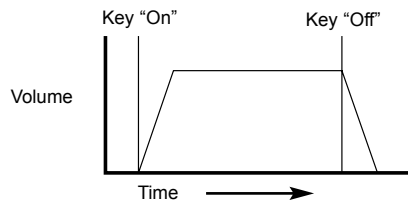

A String Section emulation attains full volume gradually when a key is pressed. It remains at full volume while the key is held down, but once the key is released, the volume level gradually falls to zero.

On an Analogue synthesizer, changes which occur throughout the duration of a note are controlled by a section known as an Envelope Generator. The K-Station has two Envelope Generators. The circuit of one of these is always connected to an *Amplifier*, which controls the Volume of the sound when a note is played.

Note that on the K-Station, there are no controls in a section on the front panel which deal with the Amplifier directly. The only way to hear and control an audio signal passing through the Amplifier is to modulate it by using Amp Envelope controls.

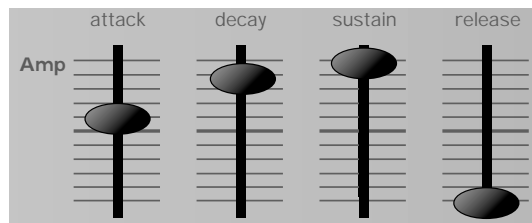

Each envelope generator has four controls which are used to adjust the shape of the envelope. The Envelope controlling the Amplifier uses sliders.

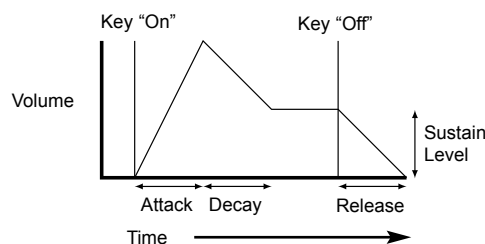

When controlling Volume, these controls adjust the following phases of the Envelope as shown in the illustration.

A = Attack time.

Adjusts the time it takes when a key is pressed for the envelope to climb from zero to full volume. It can be used to create a sound with a slow fade in.

D = Decay time.

Adjusts the time it takes for the envelope to decay from full volume to the level set by the Sustain control while a key is held down.

S = Sustain level.

Sets the volume level that the envelope remains at while the key is held down, after the Decay time has expired.

R = Release time.

Adjusts the time it takes when key is released from the Sustain level to zero. It can be used to create sounds that slowly fade away in volume.

A typical synthesizer will have one or more envelopes. One envelope is always applied to the amplifier to shape the volume of each note played. Additional envelopes can be used to dynamically alter other sections of the synthesizer during the lifetime of each note.

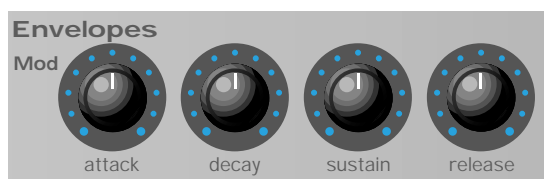

The K-Station has a second Envelope Generator which may be applied in various interesting ways. For example, it may typically be used to modify the filter cut off frequency or change an oscillators pitch during the lifetime of a note.

LFOs

Like the Envelope Generators, the LFO section on a synthesizer is a *Modulator*. That is to say, instead of forming a part of the sound synthesis process, it is used instead to modify (modulate) other synthesizer sections. For example, altering the Oscillator pitch or Filter cutoff frequency.

Most musical instruments produce sounds that vary not just in volume but also in pitch and timbre. Sometimes this variation can be quite subtle, but still contribute greatly towards shaping the final sound.

Where an Envelope is used to control a one-off modulation which occurs during the lifetime of a single note, LFOs modulate by using a cyclic repeating wave pattern. As discussed earlier, Oscillators produce a constant waveform which can take the shape of a repeating sine wave, triangle wave etc. LFOs produce waveforms in a similar way, but at a frequency normally too low to produce an audible pitched vibration that the human ear can perceive. In fact, LFO actually stands for Low Frequency Oscillator.

The waveforms generated by the LFOs may be fed to other parts of the synthesizer to create the desired movements in the sound

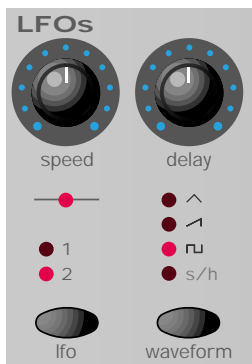

The K-Station has two independent LFOs available which may be used to modulate different synthesizer sections and run at different speeds.

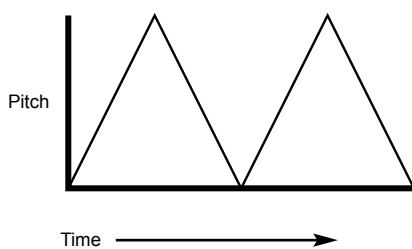

A typical waveshape for an LFO would be a Triangle wave. Imagine this slow moving wave being applied to an Oscillator's pitch. The result would be that the pitch of the Oscillator slowly rises and falls above and below its original pitch.

This would simulate, for example, a violinist moving a finger up and down the string of the instrument whilst it is being bowed. This subtle up and down movement of pitch is referred to as the 'Vibrato' effect.

Similarly, if the same LFO were applied to the Filter Cutoff frequency instead of the Oscillator pitch, a similar wobbling effect known as 'wow-wow' would be heard.

As well as LFOs being available to modulate different sections of the synthesizer, additional Envelopes may also be used simultaneously.

Clearly the more Oscillators, Filters, Envelopes and LFOs there are in a Synthesizer, the more powerful it becomes.

Memories

The first generation of synthesizers, produced many years ago were large modular machines where each part of the synthesizer was housed in a separate unit (block). These blocks could only be physically connected together by combinations of cables known as patch leads. A typical sound produced by this method would often involve connecting dozens of patch leads.

Every time a new sound was required, the leads would have to be physically disconnected and reconnected. The positions and connections of the leads would have to be noted down on paper if there was to be any hope of creating that particular sound ever again! If not reconnected in exactly the same way, the sound would be lost forever.

Modern machines such as the K-Station have all the blocks in one compact unit and the sound generating or modulator blocks are arranged in a sensible fashion. Front panel switches and knobs determine how each block functions and where the sound modifying blocks such as the LFOs and Envelopes are routed, instead of having to physically connect them externally with cables.

Additionally, the settings of these front panel controls (which of course determine the current sound or 'patch') may then be stored in memory locations in the machine which can be recalled at any time.

An Analogue synthesizer can be broken down into five main sound

Summary

generating or sound modifying (modulating) blocks.

- 1 Oscillators that generate Waveforms at a certain pitches.
- 2 A Mixer that mixes the outputs from the Oscillators together.
- 3 A Filter that removes certain harmonics, which changes the characteristic or timbre of the sound.
- 4 An Amplifier that is controlled by an Envelope generator, that alters the volume of a sound over time when a note is played.
- 5 LFOs and Envelopes that can be used to modulate any of the above.

Much of the enjoyment to be had with a Synthesizer is with experimenting with the factory preset sounds and creating new ones. There is no substitute for 'hands on' experience. Experiments with altering knobs and buttons will eventually lead to a fuller understanding of how the various controls alter and help shape new sounds.

Armed with the knowledge in this chapter, and an understanding of what is actually happening in the machine when tweaks to the knobs and buttons are made, the process of creating new and exciting sounds will become easy - Have fun.

About MIDI - MIDI messages used by the K-Station

It is recommended that this chapter is read carefully if you are unfamiliar with how MIDI works. Experienced users can skip this chapter and move on to the next chapter **Main Features and Operation** on page 13.

About MIDI

MIDI is an acronym for Musical Instrument Digital Interface. The MIDI standard was devised in the early 80's as a means for allowing musical instruments to communicate with each other as well as with other devices such as sequencers and computers. Before the advent of MIDI, it was very difficult (if not impossible) for instruments to effectively communicate with each other, especially if they had been made by different manufacturers. Nowadays, most types of electronic musical equipment are equipped with a MIDI interface fitted as standard, including synthesizers, drum machines, samplers, sequencers, computers and even some effects units.

The MIDI standard allows many different instruments to be controlled at once (say from a sequencer) using the same network of MIDI cables. Each instrument in the MIDI chain is usually assigned its own unique MIDI channel and will only respond to information that it may receive on that particular channel. The MIDI standard allows for sixteen different channels to be assigned to the various instruments in a MIDI network, which of course means that it is possible to have up to sixteen instruments playing simultaneously within a MIDI system.

It might be felt that being restricted to just sixteen MIDI channels would be a little limiting, especially for very complex pieces of music. However, some sequencers and MIDI ports for computers offer a neat way around this problem. They can offer several different MIDI outputs, each of which is treated as a separate MIDI system in its own right with its own set of sixteen MIDI channels.

The K-Station has three MIDI sockets fitted at the rear, labeled 'In', 'Out' and 'Thru'. Each one of these sockets has a specific purpose :

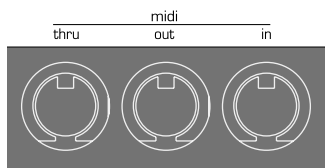

The **MIDI In** socket is used to receive MIDI information to the K-Station, such as telling it which notes to play from a sequencer for example.

The **MIDI Out** socket transmits any MIDI information which might be generated by the K-Station. For example, if a note was played on the K-Station's keyboard or one of the knobs were moved on the front panel.

The **MIDI Thru** socket simply re-transmits any MIDI information that has been received at the MIDI In socket. This socket is useful for connecting other instruments into the same MIDI network. By connecting a cable from the K-Station's MIDI Thru to another instrument's MIDI In socket, both the K-Station and the second instrument could be controlled simultaneously from a sequencer.

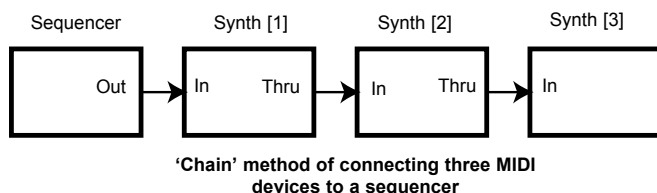

'Chain' method of connecting three MIDI devices to a sequencer

As seen above, if desired, the process can be repeated; a third instrument could be added to the same MIDI network, simply by connecting a cable from the second instrument's MIDI Thru to the third instrument's MIDI In, and so on.

Some instruments may not have a MIDI Thru socket fitted. In these cases, the instrument should be placed at the end of the MIDI chain or a Thru box should be incorporated into the MIDI system.

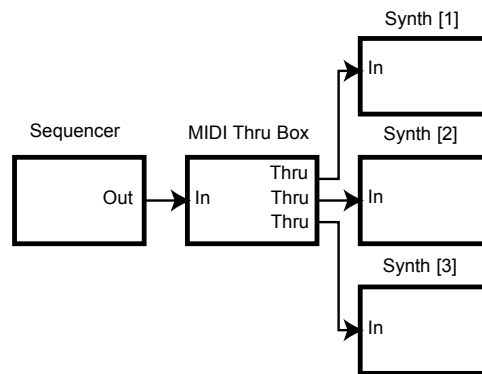

'Star' method of connecting three MIDI devices to a sequencer

A Thru Box simply provides a number of identical MIDI Thru sockets from a single MIDI In.

It is important to realise that MIDI information *flows in one direction only along the cable*. It is not possible to have a MIDI In socket connected to another MIDI In socket for example. If this were done, the MIDI network would simply not work! In fact, the only routings allowed are MIDI Out to MIDI In or MIDI Thru to MIDI In.

Some devices known as controllers are equipped with only a single MIDI Out socket and are used exclusively to generate MIDI data for controlling other instruments. Examples of common MIDI controllers are controller keyboards (these are simply keyboards with no synthesizer attached), drum percussion pads or footswitch controllers.

MIDI messages used by the K-Station

The K-Station is capable of transmitting and responding to various types of MIDI events. These are as follows :

NOTE MESSAGES

A note message is transmitted every time a key on the K-Station's keyboard is pressed down or released. When a keyboard note is pressed down, the MIDI message also includes velocity information. The velocity value in the MIDI message represents how hard the key was pressed down. This velocity value can be used to add dynamics to the sound, depending on how hard the note was played.

CONTROL CHANGE MESSAGES

These messages are transmitted whenever one of the K-Station's knobs or sliders are moved on the front panel. Most settings within a menu will also transmit MIDI control change messages when the setting is altered with the DATA knob. The MIDI specification allows for 128 different types of controller message. These are often referred to as Continuous Controllers (CC0 to CC127).

Some controllers are rigidly defined by the MIDI standard for specific functions. For example, CC1 is always used for the modulation wheel. Therefore, whenever you move the K-Station's modulation wheel, it will transmit MIDI control change information using CC1. All other makes of synthesizers will also use CC1 for modulation wheel data. However, certain other control change numbers have no set purpose within the MIDI specification. For example, whenever the K-Station's Filter FREQUENCY knob is moved, it will transmit using CC105. There is no guarantee however that other makes of synthesizer will use this control change number for the same purpose.

The K-Station actually has many more than 128 different control settings that can be transmitted by MIDI, but because the number of different types of control change message is limited to just 128, the K-Station sometimes has to use a more complicated arrangement for transmitting certain settings. This method uses what is known as NRPNS.

(NRPN stands for Non Registered Parameter Number). Users new to MIDI only need to know at this stage that NRPNs actually consist of three MIDI control change messages grouped together, rather than a single MIDI control change message which is used normally.

A full list of MIDI Control Change messages and NRPNs used by the K-Station can be found in the Appendix towards the end of this manual.

PITCH BEND MESSAGES

These messages are transmitted whenever the K-Station's pitch bend wheel is moved.

AFTERTOUCH MESSAGES

These messages are transmitted by some keyboards whenever already-held down keyboard notes are pushed further or wiggled. Aftertouch messages can be used to add extra expressiveness to a sound, for example introducing an extra vibrato effect. Although the K-Station's keyboard itself cannot generate MIDI aftertouch messages, the K-Station's synthesizer engine can still respond to aftertouch if it is received via the MIDI In socket from another keyboard or sequencer.

The MIDI specification actually defines two different types of aftertouch message; mono and poly. The type recognized by the K-Station is the mono type. Poly aftertouch includes information in the MIDI message about which keyboard note was used to trigger the aftertouch effect. Poly aftertouch is actually very rarely found nowadays as only a very few synthesizers ever used it.

PROGRAM CHANGE MESSAGES

These messages are transmitted by the K-Station whenever a new sound is called up from the front panel. However, the MIDI Specification actually only allows a MIDI program change message to select one of 128 different sounds. When the MIDI specification was originally designed, this was rarely a problem since synthesizers in those days rarely had more than 128 memories. Modern synthesizers of today such as the K-Station often offer very many more memories than this (the K-Station actually has 400 memories divided into four banks of 100 memories each), so it is often convenient to send a MIDI program change preceded by an additional MIDI message which specifies which 'bank' of sounds the following program change message will select from.

The bank select MIDI message used for this purpose is actually a MIDI control change message (CC32 is the control change number used). Whenever a new sound is selected on the K-Station, the bank select MIDI message is transmitted, followed closely by the appropriate MIDI program change message. If these messages are then later played back into the K-Station from a sequencer, the appropriate sound will be then selected instantly.

It is not strictly necessary to always send a bank select message before the program change message (though recommended). It is permitted to omit the bank select, but if this is done, the program change message will select the sound from whatever bank of sounds is currently selected.

Channel Messages

All of these different types of MIDI message detailed above include information detailing which MIDI channel was used when the message was transmitted. MIDI channel messages will only affect receiving devices using the same MIDI channel. For example, a pitch bend message sent using MIDI channel 1 would have no effect at all if it were received on a synthesizer set to respond on MIDI channel 2.

Some MIDI messages do not include any MIDI channel information defined in them. Some examples of these are :

MIDI CLOCK MESSAGES

These are synchronization messages sent from a sequencer. When received, they enable tempo-locked features of the K-Station such as the arpeggiator and various effects settings (such as Panning and Delay sync) to follow the current tempo of the sequencer. The K-Station itself does not transmit MIDI clock messages, so it can only be synchronized to follow the tempo of other devices and not vice versa.

Whenever an external sequencer is started, a Start Song MIDI message is usually transmitted. Certain features on the K-Station can be set to reset their synchronisation when a Start Song message is received.

SYSTEM EXCLUSIVE MESSAGES

This is a special type of MIDI message which can actually contain any type of data, depending what the synthesizer manufacturer decides to put in it! The only constraint with system exclusive messages is that they always contain certain header information which is exclusively used by the manufacturer (and usually the relevant synth model as well). What this effectively means is that a K-Station will only accept a system exclusive message designed especially for it. If the K-Station should receive a system exclusive message transmitted by a different make of synthesizer, the message would simply be ignored. Similarly, other makes of synthesizer will ignore any system exclusive messages originally sent by a K-Station.

Novation have employed system exclusive messages for two distinct purposes on the K-Station. Firstly, they can be used to back up all of the K-Station's memories and global data. This feature is extremely useful in building up a sound library on a computer or for making a safety copy of sound and global data. This data backup format is actually fully compatible with the Novation A-Station, so it is easily possible to transfer sounds from the A-Station to the K-Station or vice versa. Data backup is discussed in detail on Page 33 in the **Advanced Features** chapter.

Secondly, Novation also use system exclusive messages to enable a K-Station to update its entire operating system via MIDI. The latest operating system for the K-Station is always available free of charge at the Novation web site. From there, it can be downloaded as an SMF (Standard MIDI File).

Because the operating system update consists purely of MIDI system exclusive messages, it can then be transferred to the K-Station simply by playing the file on a sequencer directly into the K-Station. However, as a safety feature, the K-Station has to be put into a special mode where it will accept the operating system update. Full details on how to do this will be supplied when you download the update.

For list of the latest operating system updates please see the Novation Website :

www.novationmusic.com

A MIDI Implementation Chart provides a concise way of telling at a glance which MIDI messages an instrument will transmit and respond to. A MIDI Implementation Chart for the K-Station can be found on in the Appendix towards the end of this manual.

MIDI and Sequencers

A sequencer is simply a device which is capable of recording, storing and playing back MIDI information. Using a sequencer, it is possible to construct very complex musical arrangements which would normally be impossible to play 'live'. It is also very easy to edit the MIDI data and remove any unintended mistakes or make changes in the playing style. Many people nowadays use software sequencing packages on computers, but there are also dedicated hardware sequencers available which perform in a similar way.

All sequencers can record MIDI information exactly as played on the synthesizer's keyboard. To do this with the K-Station, make sure the MIDI Out from the K-Station is connected to the sequencer's MIDI In and start the sequencer recording. Any keys played on the keyboard or knob / wheel movements made will be faithfully recorded. This is known as 'real time' recording. As long as the sequencer's MIDI Out is connected to the K-Station's MIDI In, this MIDI information can then be played back into the K-Station, exactly reproducing all the actions made and notes you played while recording the sequence.

On most sequencers, it is also possible to enter new MIDI events in 'step time' by explicitly defining each MIDI event without having to supply the relevant MIDI data to the sequencer's MIDI In socket. Obviously, some knowledge of MIDI is required in order to do this.

Nearly all sequencers offer multiple recording tracks. These tracks behave in a similar fashion to multi-track tape recorders, except that instead of holding audio recordings, they hold their own record of MIDI data. Usually, each sequencer track will contain MIDI data associated with a distinct MIDI channel. By using sequencer tracks in this way, it would typically be possible to build up a complex song arrangement with one track being used to control the drums, another the bass line, another the lead sound and so on.

It should be remembered that the K-Station is a mono-timbral instrument which means that it is only capable of playing one type of sound at any one time. If it is desired to create complex pieces of music using a sequencer, it will therefore become necessary to either use a multi track audio recorder to record each track played, or a computer based hard disk audio recorder, or include other instruments into the MIDI network alongside the K-Station.

When using a sequencer, some careful thought should be given as to the way the MIDI information is routed through the sequencer. With most sequencers, any MIDI information that appears at the sequencer's MIDI In socket is immediately re-transmitted again from the sequencer's MIDI Out socket. If desired, it is sometimes possible to turn this feature off. It usually called 'echo back' or 'soft thru'. Consult your sequencer manual for details.

It is very important to realise that if 'soft thru' is enabled on a sequencer, the MIDI information re-transmitted by the MIDI Out socket is always converted to the MIDI channel used by the currently selected sequencer track. This means that if a track is selected on a sequencer which uses MIDI channel 2, and the sequencer then receives some MIDI information from a K-Station sent on MIDI channel 1, *it will be re-transmitted by the sequencer not on MIDI channel 1, but MIDI channel 2.* (This is known as re-channelising) This would be quite useful for programming parts into the sequencer for other MIDI devices, but can lead to some quite unexpected results if careful note is not kept of exactly what is happening !

Because many sequencers re-channelise MIDI information in this way, it is quite possible to use the K-Station as a master keyboard to supply MIDI information and notes that the sequencer will use to control other MIDI equipment, for example a sampler. To do this, firstly the sequencer track must be selected which corresponds to the same MIDI channel that the sampler is using. However, it would be noticed that as soon as notes are played into the sequencer from the K-Station keyboard, the K-Station would play as well as the sampler. To overcome this problem, there is a feature on the K-Station called **Local Control**.

Local Control

Local Control is a setting found in the Global Menu (see page 34 for details) which in effect is a switch, that connects or disconnects the K-Station's keyboard and panel controls from the K-Station's synthesizer engine.

When the keyboard is played or the front panel controls are moved, they still transmit the usual MIDI information *but they have no direct control of the K-Station*. When **Local Control** is set to **OFF**, the only way that the K-Station's keyboard or controls can be used to play the K-Station is when the MIDI information sent from the K-Station is routed through the sequencer (with the correct sequencer track selected), back to the K-Station's MIDI In socket.

When not connected correctly to a sequencer, having **Local Control** set to **OFF** is a common cause of mistakenly assuming that the K-Station is faulty. When the K-Station appears to ignore its keyboard and front panel controls, setting **Local Control** to **ON** or selecting the correct sequencer track will usually rectify the 'problem'.

Summary

The K-Station transmits MIDI information whenever the keyboard is played, front panel controls are moved or when a new Program is selected.

MIDI information is split into 16 channels. The K-Station can be set to receive / transmit on any one of these channels at any one time.

MIDI information travels in one direction along a MIDI cable. The only permitted connections are MIDI Out to MIDI In, or MIDI Thru to MIDI In.

MIDI messages can be recorded into a sequencer and later replayed back into the K-Station, replicating whatever actions occurred when the MIDI messages were originally transmitted.

Sequencers usually re-transmit any MIDI information they receive immediately, converting the message's channel information into whatever MIDI channel the currently selected sequencer track is using.

Because of this, the K-Station may be used as a 'Master Keyboard' to control all MIDI devices in a MIDI network.

An option called **Local Control** disables the K-Station's keyboard and controls from the K-Station's synthesizer engine. When set to **OFF**, playing the K-Station's keyboard or moving the front panel controls only results in MIDI information being transmitted.

Setting **Local Control** to **OFF** allows the K-Station to control other MIDI instruments without triggering notes or altering settings on the K-Station directly.

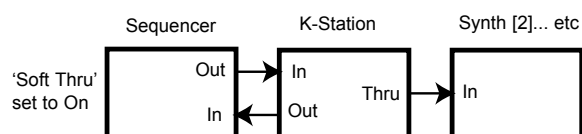

Typical example of using the K-Station as a Master Keyboard in a MIDI system

This chapter describes the main front panel controls and how they affect a sound and the operation of the K-Station.

Front Panel Layout

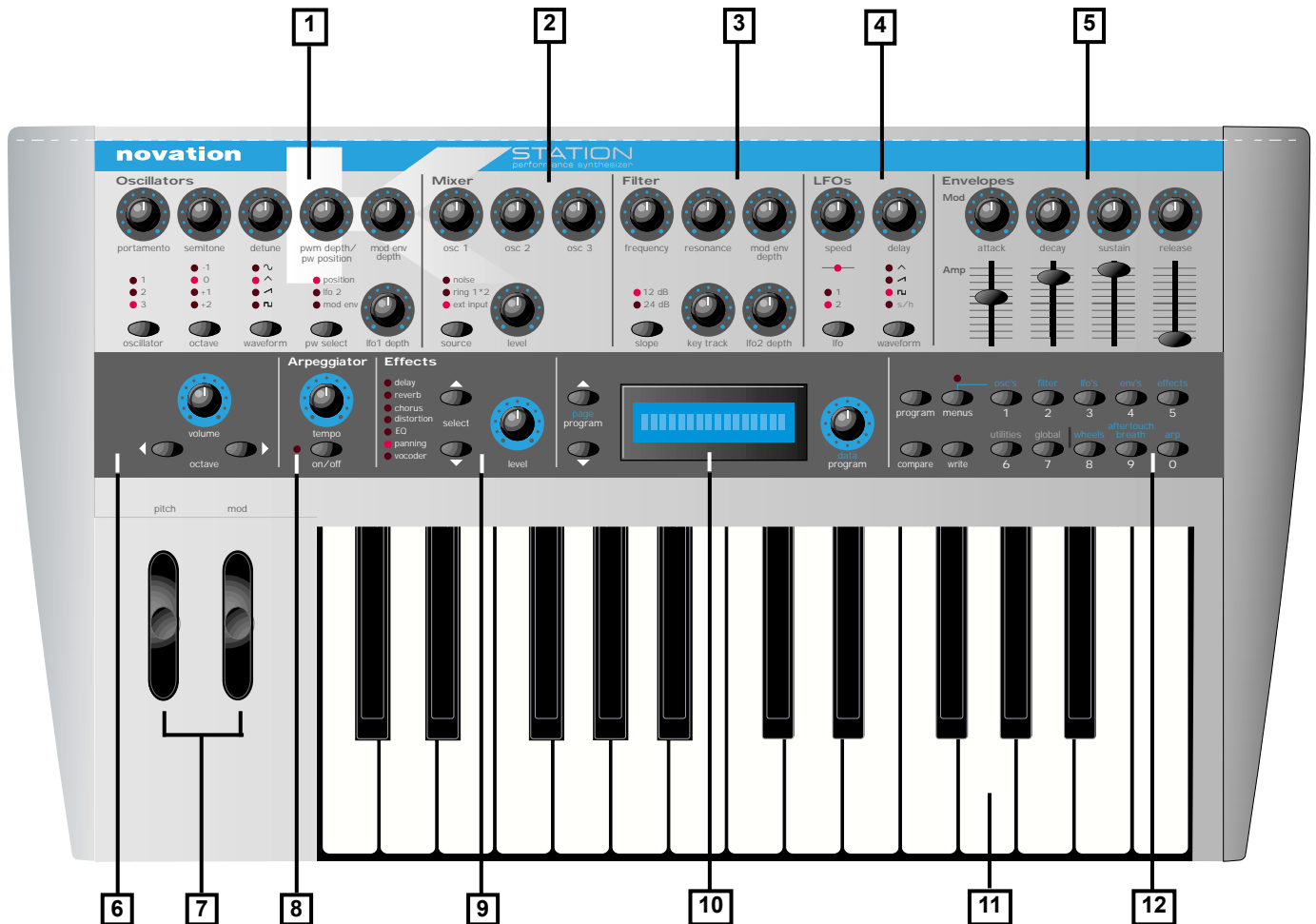

1 - Oscillator Section

Contains the controls associated with the Oscillators. These include the PORTAMENTO, SEMITONE tune, DETUNE, PWM DEPTH / PW POSITION, MOD ENV DEPTH and LFO 1 DEPTH knobs and the OSCILLATOR select, OCTAVE, WAVEFORM and PW buttons.

2 - Mixer Section

Contains the controls associated with the Mixer. These include the OSC 1 level, OSC 2 level, OSC 3 level and source LEVEL knobs and the mixer SOURCE button.

3 - Filter Section

Contains the controls associated with the Filter. These include the FREQUENCY, RESONANCE, MOD ENV DEPTH, KEY TRACK and LFO 2 DEPTH knobs and the filter SLOPE button.

4 - LFO Section

Contains the controls associated with the K-Station's two LFOs. These include the SPEED and DELAY knobs and the LFO select and WAVEFORM buttons.

5 - Envelopes Section

Contains controls associated with the K-Station's two Envelopes. There are two sets of ATTACK, DECAY, SUSTAIN and RELEASE controls. Knobs are used for the Mod Envelope and Sliders are used for the Amp Envelope.

6 - Master Volume and Keyboard Octave buttons

7 - Performance Controls Section

Contains the PITCH bend and MODulation wheels.

8 - Arpeggiator Section

Contains controls associated with the Arpeggiator. These include the TEMPO knob and Arpeggiator ON / OFF button.

9 - Effects Section

Contains controls associated with the various effects. These consist of the Effects LEVEL knob and the Effects SELECT buttons.

10 - Display and Data Entry Section

Contains the display, a DATA / PROGRAM knob and two PAGE / PROGRAM buttons.

11 - Two Octave Keyboard

12 - Mode and Keypad Section

Contains the PROGRAM, MENUS, COMPARE and WRITE buttons and the numeric keypad / Menu select buttons.

Modes and menus

The K-Station has three modes of operation.

1. Program Select Mode

This mode enables a new Program to be selected from the front panel controls.

Program Select Mode may be selected at any time by pressing the PROGRAM button.

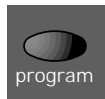

While the K-Station is in Program Select Mode, the display will show the currently selected Program's number. For example,

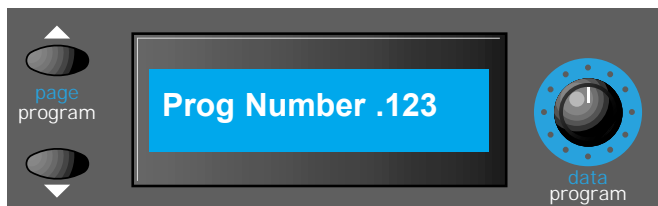

Once in Program Select Mode, it is now possible to select a different Program by one of three methods.

i) The DATA / PROGRAM knob may be used to select a new Program. Programs can be selected forwards or backwards from the one currently selected. Turning the knob quickly increases the intervals jumped between Programs.

ii) The PAGE / BUTTONS may also be used to step forwards or backwards from the currently selected Program. If a PAGE / PROGRAM button is held down, the Programs will jump in intervals of ten. This can be useful since the Preset Programs have been grouped in types located ten Programs apart.

iii) Programs may also be explicitly selected by typing a three digit sequence on the numeric buttons. The Program will not actually be selected until the third digit has been entered.

Note that the K-Station does not have to be in Program Select Mode in order to select a new Program via MIDI (from a sequencer for example). A new Program may be selected via MIDI at any time and in any mode.

2. Program Edit Mode

As soon as any of the front panel settings are altered, the K-Station will exit Program Select Mode and the display will show the new value of the control just altered. By altering a setting in this way, The K-Station automatically enters Program Edit Mode.

If for example, the Filter FREQUENCY knob was adjusted to 100, the display would now show

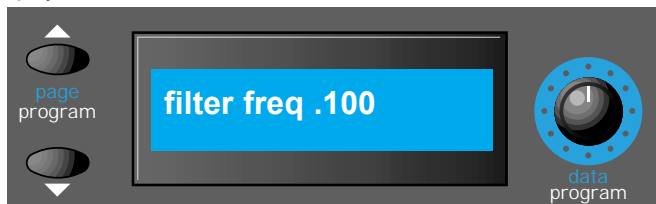

Note: The character next to the first numeric digit will alter its shape as controls are moved. This is the Original Value indicator and is explained in detail on Page 22.

Once a setting has been called up to the display in this way, the DATA / PROGRAM knob may also be used to adjust setting's value.

While in Program Edit Mode, it is possible to return to Program Select Mode by pressing the PROGRAM button. As in Program Select Mode, it is also possible to select a new Program directly by entering three digits on the 0 - 9 / Menu select buttons. After selecting a new Program in this way, the K-Station will enter Program Select Mode.

Note : By altering the Global **Prog Mode Display Control** setting, it is possible to make the K-Station always automatically revert back to Program Select Mode after a short period of time. See Page 36 in the **Advanced Features** chapter for more details.

3. Menu Mode

Many of the K-Station's more advanced features and utilities are only available from within menus. The K-Station has ten separate menus, each of which consists of several pages linked together. Menu pages may only be accessed while the K-Station is in Menu Mode. Menu Mode is entered by pressing the MENUS button.



The K-Station always indicates that Menu Mode is active by illuminating the LED situated above the MENUS button. As soon as Menu Mode is entered, the display will show a page of whichever menu was accessed the previous time Menu Mode was used. For example, if the Filter Menu had been previously selected, the display would show one of the pages of the filter menu as below. - The exact page will depend on the setting of the **New Menu Always Page 1** found in the Global Menu as described on page 36.

The PAGE buttons to the left of the display can be used to navigate

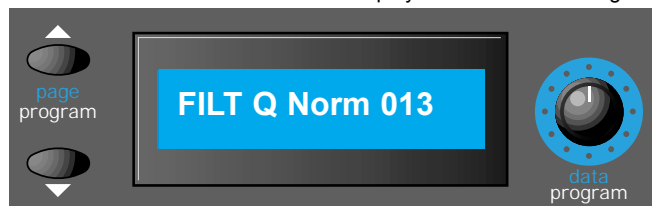

forwards and backwards between the menu's pages. Once the desired menu page has been reached, the setting can be altered by using the DATA knob.

In Menu Mode, a different menu may be selected by pressing the appropriate 0 - 9 / Menu Select button. The ten menus available are associated with the Oscillators, Filter, LFOs, Envelopes, Effects, Utilities, Global settings, Wheels, Aftertouch / Breath Control and the Arpeggiator.

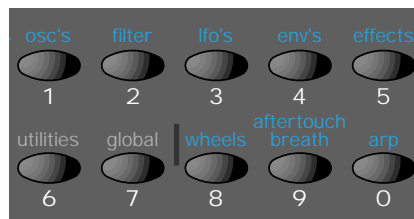

In Menu Mode it is still possible to alter any of the front panel controls, but it will be noticed that when a knob is moved, the display text for the knob just moved will only be shown on the screen for a short period of time (as set by the Function display time in the Global Menu on Page 36) After a short time, the display will revert back to showing the current menu page.

It is possible to leave Menu Mode and return to Program Select Mode by pressing the MENUS button again (the LED above the MENUS button stops blinking), or by pressing the PROGRAM button.

Mixer Section

LFO 1 DEPTH Knob

Controls the amount of pitch modulation to an Oscillator from LFO 1. It controls how much above and below the basic pitch the Oscillator regularly rises and falls. If the LFO is set to Triangle wave and the LFO's speed knob is above the centre of its range, this will produce a vibrato effect. Other effects like a siren or sea gull cry are possible with more extreme settings.

Other functions associated with the Oscillators can be found in the Oscillators Menu. See Pages 23 - 24.

Mixer Section

The Mixer makes it possible to combine the outputs of Oscillators 1,2 and 3, the Noise source, the Ring modulator and the external Audio Input. The ability to mix together any or all of these sound sources makes it easy to create complex timbres.



OSC 1, OSC 2 & OSC 3 Knobs

Controls the volumes of the three Oscillators. Fully anticlockwise results in no signal. In this position and with all the other Mixer levels turned down, there will be no audio output. Fully clockwise results in full volume for this Oscillator.

SOURCE Button and LEVEL Knob

The SOURCE button selects which sound source the LEVEL knob will control.

With the NOISE position selected, it controls volume of the White Noise Generator. White Noise is useful for creating sound effects such as Wind.

With the RING 1 * 2 position selected, it controls the volume of the Ring Modulator. Ring Modulation is useful for creating harder Metallic tones.

With the EXT position selected, it controls the volume of an external audio signal connected to the INPUT socket on the K-Station's rear panel. This signal can be processed by the filter, envelopes and effects.

An external audio signal may be a microphone, CD player, guitar etc. With a little experimentation, quite effective and dramatic changes to the sound can be produced : Filtering, wah-wah, gating, using the Effects Section for adding reverb, chorus etc. Experiment !

Note: All three sound sources may be used simultaneously and if they are, it may be necessary to reduce the **Program Level dB** in order to avoid signal distortion (see page 26).

Filter Section

The K-Station's Filter is a Low Pass type. As the FREQUENCY knob is adjusted anticlockwise, harmonics are gradually removed from the sound. When almost closed, only the fundamental frequency remains. Fully closed and no sound at all passes. This type of Filter is musically the most useful, especially for bass sounds.

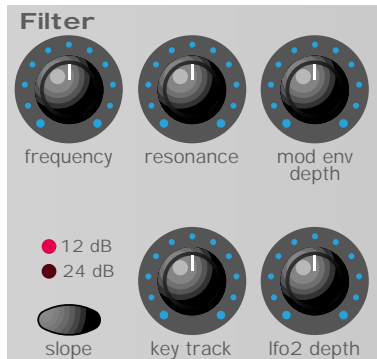

FREQUENCY Knob

This controls the basic Cut off frequency of the filter. Set fully clockwise, the filter is wide open allowing all frequencies (harmonics) produced by the Oscillators to sound. As the knob is turned anticlockwise, the filter closes, cutting out harmonics, starting with the highest, then increasingly lower ones until only the fundamental or nothing at all is allowed to sound (fully anticlockwise).

If there is silence when the VOLUME knob is turned up, it is most likely that the Filter is fully closed. Turn the Frequency knob clockwise to open the filter.

RESONANCE Knob

This knob controls the Resonance of the Filter. The control will boost frequencies at the Cut off frequency. On some synthesizers, this control is known as Emphasis since it will emphasize certain frequencies. At the zero position there is no effect. Turning clockwise slowly introduces the emphasis.

Set fully clockwise, the Filter will begin to self - oscillate, producing a new pitched element (similar to feedback on an electric guitar).

Note : At least a small signal must be fed into the Filter in order for the resonance to take effect. It is not possible for the filter to self - oscillate if no signal at all is fed into it.

If the K-Station produces a high pitched whistling sound, it is probably due to this knob is being adjusted too far clockwise. If this self-oscillating effect is not desired, keep the Resonance control away from the extreme clockwise setting. Increasing the Resonance is very good for bringing out modulation (movement or change) in the filter Cut off frequency, such as in Acid bass lines and other very edgy sounds.

MOD ENV DEPTH Knob

Controls the amount of change to the filter Cut off (set by the FREQUENCY knob) by the Modulation Envelope. In its central position there is no change to the filter Cut off frequency. Adjusting the knob anticlockwise from centre will introduce an increasing amount of negative modulation. The filter will close as the MOD ENV runs through its cycle. Adjusting the knob clockwise from centre will introduce an increasing amount of positive modulation. The filter will be opened by the MOD ENV.

SLOPE Button

Controls how drastically the frequencies above the Cut off point are removed from the sound. When the 12dB position is selected, the Cut off slope is gentle so higher harmonics are not attenuated (reduced in volume) as sharply as they are when the 24dB position is selected.

KEY TRACK Knob

Controls the amount of change to the filter Cut off (set by the FREQUENCY knob) by the pitch of the note played. Set fully anticlockwise and there is no change to the filter Cut off frequency. With clockwise movement there will be an increasing amount of modulation. The filter will be opened more as higher notes are played on the keyboard. This control is used to define how the timbre of a sound changes over the keyboard.

At the fully clockwise position, the filter tracks the pitch changes in a 1 to 1 ratio. This means that with RESONANCE set to a high level, the pitch of the Filter's self - oscillation will increase in semitone steps as notes are played on the keyboard. This effect is akin to adding an extra (Sine Wave) Oscillator to the sound when notes are played on the keyboard.

LFO 2 DEPTH Knob

Controls the amount of change to the filter Cut off (set by the FREQUENCY knob) by LFO 2. In its central position there is no change to the filter Cut off frequency. Adjusting the knob anticlockwise from centre will introduce an increasing amount of negative modulation. The Filter will close and open in time with LFO2 (this creates the popular wow wow effect of LFO2 waveform is set to Triangle).

Adjusting the knob clockwise from centre will introduce an increasing amount of positive modulation. The filter will open and close in time with LFO 2.

NOTE : An external audio signal such as a microphone, guitar or CD player may be processed by the filter and effects. Refer to Page 36 in the **Advanced Features** Chapter for more details on setting up this feature.

More functions associated with the Filter can be found in the Filter Menu. See Page 25.

LFO Section

There are two LFOs - Low Frequency Oscillators - available on the K-Station. These produce regular electronic variations which are too low to be heard when converted into audio vibrations. They can be used to modify various elements of the sound, producing regular changes in pitch (vibrato), pulse width or filter Cut off.

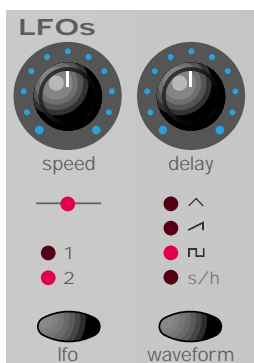

SPEED Knob

Controls the speed of the low frequency Oscillations. An LED directly below the knob indicates the speed. Faster speeds are set by turning the knob clockwise. These are suitable for vibrato and tremolo effects. Slower speeds are more appropriate for Pulse Width changes or special effects.

DELAY Knob

Controls how long after the note is struck the selected LFO begins to take effect. Fully anticlockwise and the selected LFO effect will begin immediately. Turning clockwise will cause the LFO effect to fade in. The time of the fade in is dependent on the knob position. This is used for delayed vibrato effects.

LFO Select Button

Selects which LFO the SPEED, DELAY and WAVEFORM controls relate to. Select position 1 for LFO 1 and 2 for LFO 2.

WAVEFORM Button

Selects the waveform shape for the selected LFO.

TRI - Triangle waveform gives the smoothest continuous change in level to the LFO. When routed to pitch, it introduces vibrato or a siren effect dependent of its speed setting. When routed to Filter Cut off, a Wow Wow effect results.

SAW - Sawtooth waveform generates a rising level which then jumps back up to zero level. Routed to the Filter Cut off, it produces a rhythmic pulse effect. Routing it to pitch produces siren type sounds.

SQR - Square waveform changes level instantly from minimum to maximum. This waveform is useful for trills and computer game effects.

S/H - Sample & Hold. At a regular interval (governed by the SPEED knob), the level of the LFO jumps to a new random level and stays there until the next jump. This creates a rhythmic effect particularly if routed to the Filter Cut off. Routing this to pitch gives a less musical result, but is useful for computer or machinery sound effects.

Additional settings associated with the LFOs can be found within the LFOs Menu. See Page 25.

Envelopes Section

AMP and MOD Envelopes

The Envelopes are used to shape a sound throughout its duration. The AMP Envelope determines the volume of the sound with respect to its duration.

The MOD Envelope may be used to control other sound elements of the synthesizer throughout the duration of the sound. It can control Oscillator Pulse Width, Filter frequency and Oscillator Pitch.

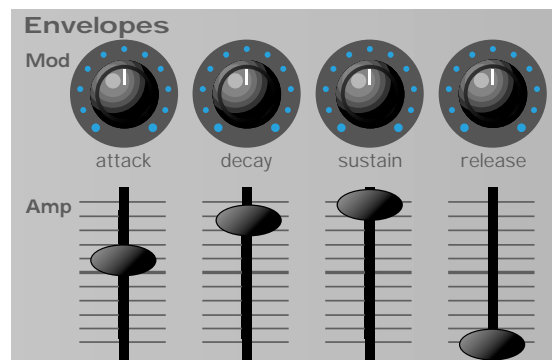

ATTACK Knob / Slider

Sets how quickly the envelope rises to its maximum level when a note is struck. Fully anticlockwise and this rise time or slope is very fast, less than half a thousandth of a second (instantaneous to the ear) increasing exponentially to twenty seconds when fully clockwise. To shorten attack times, turn this control towards zero and to lengthen attack times, turn this control towards maximum.

Note : When the attack time is set to Zero, the instantaneous rise time of the Envelope may produce audible 'clicks'. This is not a faulty condition and may be useful for the creation of certain sounds (for example, 'key clicks' on organ simulations). If this is undesirable, increase the Attack time until the clicks are inaudible.

DECAY Knob / Slider

Sets how quickly the envelope falls to a sustain level after the maximum level has been reached. Set to zero, this time is about one thousandth of a second (still instantaneous to the ear) increasing exponentially to twenty seconds when set to maximum. To shorten decay times, move this control towards zero and to lengthen decay times move this control towards maximum.

SUSTAIN Knob / Slider

Sets the level at which the envelope remains following the Decay phase, only while a key is being held on a controller keyboard (or there is a MIDI Note On command present). When set to zero, the envelope will decay to zero without being interrupted. As the control is moved towards maximum, the sustain level increases until, when at maximum, the sustain level is at its maximum level.

RELEASE Knob / Slider

Sets how quickly the envelope falls from the sustain level to zero once the note has been released. When set to zero, this time is about one thousandth of a second (instantaneous to the ear) increasing exponentially to twenty seconds when set to maximum. To shorten release times, move this control towards zero and to lengthen release times, move this control towards maximum.

Additional settings associated with the Envelopes can be found within the Envelopes Menu. See Page 26 - 27.

Volume and Keyboard Octave Controls

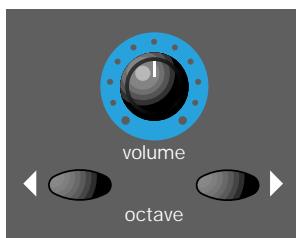

VOLUME Knob

This control adjusts the *overall output volume* on both the Left and Right master audio outputs on the rear panel and the Headphone output also on the rear panel. Using a mixing desk as a comparison, this control can be thought of as the channel volume fader.

Keyboard OCTAVE Buttons

These buttons allow the K-Station's two octave keyboard to be shifted up or down by a whole octave. The entire MIDI note range of C-2 to G8 can be accessed.

To return to a mid position where the A above middle C on the keyboard is 440Hz. Press BOTH the Up and Down Octave buttons simultaneously.

Note : When set to the highest octave setting, the top notes on the keyboard beyond G8 will not trigger the K-Station or transmit MIDI Note messages because they will be outside of the note range defined by the MIDI specification.

The Keyboard octave setting is memorized along with all of the other sound information when a Program is written to memory.

Arpeggiator Section

The K-Station includes an Arpeggiator which breaks down chords into single notes and plays them one at a time. For example, if a 'C' triad chord is held, the notes C, E and G will play one by one in sequence.

Which Arpeggiator pattern is used and how the sequence of notes are played is determined by settings of the functions located in the Arpeggiator Menu. See Page 38 in the **Advanced Features** chapter for more details on these.



TEMPO Knob

This controls the speed at which the Arpeggiator plays back its notes. When turned fully anticlockwise, the Arpeggiator will step through a sequence at 64 beats per minute. Clockwise movement increases speed. The maximum speed available is 191 b.p.m.

When the Global **MIDI Clock Source** value (see Page 35) is set to **INT**, this knob also controls the tempo of any synchronized Chorus, Delay, Panning or EQ effects. See Pages 28, 29-30, 31 & 32 for details on how to synchronise these.

When **MIDI Clock Source** is set to **EXT**, the tempo of any synchronized Arpeggiator, Chorus, Delay, Panning or EQ will be controlled by the tempo of the external sequencer instead of the TEMPO knob which will have no effect on the speed.

If this knob appears to have no effect on the tempo, the reason is probably due to **MIDI Clock Source** being set to **EXT** or that the external sequencer is currently stopped (stopped sequencers do not usually transmit MIDI Clock messages).

ON / OFF Button

This activates / deactivates the Arpeggiator. While the Arpeggiator is activated, the LED to the left of the button will be lit.

Pressing and holding this ON/OFF button for longer than 1 second will cause the Arpeggiator to Latch . When latched, the Arpeggiator sequence will continue to play even after notes have been released.

Once all notes on the keyboard have been released, the next chord to be played on the keyboard will clear the existing latch memory and only the newly played chord will be Arpeggiated.

Effects Section

The K-Station is equipped with seven different Effects which may be used simultaneously. These effects are saved as an integral part of a sound when writing it to memory. Adding Effects to a sound can dramatically enrich the overall sound texture. Some types of Effect are particularly useful in giving a sound a perceived position in three-dimensional space. Adding such sounds to final mix of a piece of music gives a much greater sense of 'depth'.

Each type of Effect has several settings associated with it which give fine control over how the Effect interacts with a sound. These settings may be changed using the various Effects menus. See Page 28 in the **Advanced Features** section for more details.

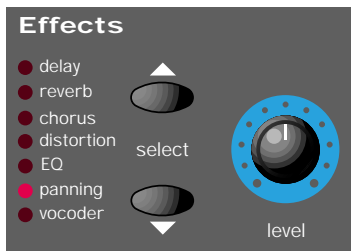

Effects SELECT buttons

These two buttons are used to select which of the seven Effects is currently being edited. The seven types of Effect available are :

Delay

This Effect simulates the echoes which would be heard when a sound is reflected off of a hard, flat surface such as stone wall. The K-Station actually incorporates a stereo version of this echoing effect.

To visualize a stereo echo, imagine a sound being produced between two stone walls. The echoes of the sound would bounce off each wall in turn until the echoes eventually dies away.

Use the LEVEL knob to introduce the Delay effect.

Reverb

The Reverb Effect simulates the acoustic properties of a room. In everyday life, the materials that a room is made of and its size determine how sound waves are reflected from the room's walls. Consider as an example, how different a sound is when heard in bathroom with tiled walls. Singing in particular can be dramatically improved !

Chorus

This is a swirling, stereo Effect, often useful for 'fattening up' a sound, creating an impression that several synthesizers are being played in unison, rather than just one.

This effect is actually achieved by slightly detuning the sound and adding it back to the original signal.

A similar, related effect to Chorus is the Phaser. Phasers phase-shift certain frequencies of a sound and add them back to the original signal. This gives a sound passed through a Phaser, a distinctive swishing quality. At extreme settings, this can sound similar to jet plane passing overhead!

In the Chorus Menu, it is possible to select whether the K-Station's Chorus Effect behaves as a standard Chorus or as a Phaser.

Use the LEVEL knob to introduce the Chorus or Phaser effect.

Distortion

As its name suggests, the Distortion Effect distorts a sound signal. Imagine how a sound recorded onto tape sounds when it has been recorded with the record level far too high. Much loved by guitarists,

distorted sounds have a very gritty, dirty quality to them. This is especially effective when applied to aggressive lead sounds.

The Distortion Effect also exaggerates any low-level harmonics present within the sound. Sounds using a level of RESONANCE in the Filter will especially benefit from added Distortion.

Use the LEVEL knob to introduce the Distortion effect.

EQ

The EQ (short for Equalization) Effect provides a way of diminishing or emphasizing a specific frequency range within the final sound. It is in fact, a form of Filter similar to the one found in the K-Station's Filter section. It performs a similar function, but it cuts or boosts certain frequencies.

The actual frequency range which will be cut or boosted is determined by the EQ Frequency Point (the **EQ Frequency** setting) which is set within the Effects Menu. See Page 31 in the **Advanced Features** chapter for details on how to set this.

The amount of cut or boost applied will depend on the position of the Effects LEVEL knob. When set to the 12 o'clock position, no cut or boost is applied. As the knob is turned anticlockwise from the 12 o'clock position frequencies *below* the EQ Frequency point will be boosted and frequencies above the point will be attenuated. As the knob is turned clockwise from the 12 o'clock position, frequencies *above* the EQ Frequency will be boosted and those below attenuated.

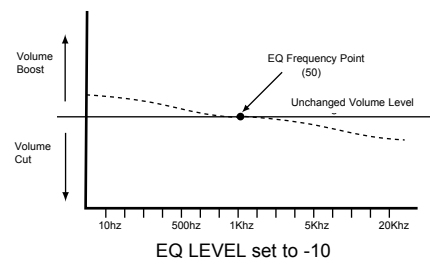

In the above example, The EQ **Frequency** point has been set to **50** and the EQ LEVEL set to **-10**. This has the effect of gently boosting the lower (bass) end of the frequency spectrum and cutting the higher (treble) frequencies.

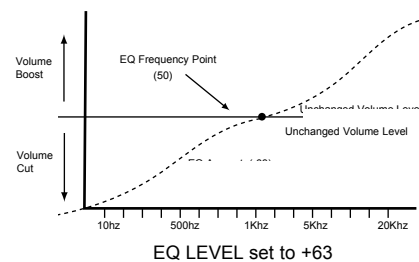

In this example, the EQ LEVEL has been set to its maximum possible positive setting of **63**. This results in a dramatic boost in the higher (treble) frequencies and a reduction in lower (bass) frequencies.

Panning

The Panning effect dictates where in the stereo field a sound is placed when heard through stereo speakers or headphones. It is possible to position a sound hard to the left, hard to the right or anywhere in between.

The Effects LEVEL knob positions the sound in the stereo field. When set fully counter-clockwise, the sound will only be heard on the left-hand side. At the full clockwise position, the sound will be heard only on the right-hand side. When set at the 12 o'clock position, the sound is heard on both sides at an equal level.

Vocoder

A Vocoder is a device which analyzes selected frequencies present in an audio signal (called a *Modulator*), and superimposes these frequencies onto another sound (called the *Carrier*).

It actually does this by feeding the Modulator signal into a bank of band pass filters. Each of these filters (12 of them on the K-Station) covers a set band in the audio spectrum from low to high frequencies.

In the K-Station's Vocoder, a Program (for example a string sound) is always used as the Carrier. It is routed to another complete set of 12 filters that have the same frequency band settings as the bank of filters used for the Modulator. Each of the outputs from the 12 band pass filters in the Modulator bank control the volume of each of filters in the Carrier bank.

The final character of the vocoded sound will depend greatly upon the harmonics present in the Carrier Program. Programs very rich in harmonics (for example using Sawtooth Waves) will generally give the best results.

Typically, the Modulator signal used by a Vocoder would be a human voice speaking into a microphone. This creates the distinctive robot or 'talky' like sounds which have recently returned to popularity and are now being used more frequently in modern Pop and Dance music.

Bear in mind however, that the Modulator signal need not be restricted to human speech. Other types of Modulator signal can be used (for example, an electric guitar or drums) and can often give quite unexpected and interesting results.

Modulator audio signals such as from a microphone or CD should always be fed into the K-Station's AUDIO IN socket, located on the rear panel.

The pitch of the final vocoded sound will depend on whatever pitch the Carrier (currently selected Program) is playing. Notes can either be played on the K-Station's keyboard or received via MIDI from an external keyboard or sequencer. These notes must be played simultaneously while the Modulator signal is present, otherwise the Vocoder effect will not appear to work.

The Vocoder is activated and balanced by using the Effect LEVEL knob. When this knob is turned fully counter-clockwise, the Vocoder is disabled. As the knob is slowly turned clockwise from the full counter-clockwise position, the Carrier signal will be heard. As the knob is moved towards the 12 o'clock position, the Carrier signal will diminish and the fully vocoded sound will become more prominent. At the 12 o'clock position, only the fully vocoded will be heard. The Carrier or Modulator signals will not be present. As the LEVEL knob is moved clockwise from the 12 o'clock position, more of the raw Modulator signal will be introduced until at the fully clockwise position, only the Modulator signal will be present.

More settings are available to help shape the final Vocoder Effect. These are detailed on Page 33 in the **Advanced Features** chapter.

Note : If either of the Effect SELECT buttons are pressed while the Effects Menu is active in **Menu Mode**, the display will be updated to show settings relevant to the newly-selected Effect.

Effects LEVEL knob

This control's function depends upon the Effect currently selected for editing by the SELECT buttons. In most cases, it will control the Effect's level, but there are exceptions. All possibilities are detailed in the table given below.

Effects Level Knob			
Effect Selected	Function	Display	Value
Delay	Delay Level	Delay Send	0...127
Reverb	Reverb Level	Reverb Send	0...127
Chorus	Chorus Level	Chrous Send	0...127
Distortion	Distortion Boost	Distortion	0...127
EQ	EQ Cut/Boost	Equalisation	-64...63
Panning	Stereo Pan Position	Pan Position	-64...63
Vocoder	Vocoder On/Balance	Vocoder Bal	0...127

Display and Data Entry Section



As well as containing the display, this section also contains controls, whose vary according to which *mode* the K-Station is currently in. For more information on modes, refer to the section **Modes and Menus** on Page 14.

PAGE / PROGRAM Buttons

While in **Program Select Mode**, these buttons may be used to advance / decrease the currently selected Program. If pressed and held down, the Programs will start advancing / decreasing in steps of ten Programs at a time. This is useful since on the K-Station, similar types of sound are spaced apart at ten Program intervals.

While in **Menu Mode**, these buttons are used to move up and down through the various linked pages within the currently selected menu.

DATA / PROGRAM Knob

In **Program Select Mode**, this knob may be used to step forwards or backwards through the available sounds (programs). The interval used in stepping through the Programs is determined by how quickly the knob is turned.

In **Program Edit Mode**, this knob may be used to adjust the value of any functions displayed on the screen.

In **Menu Mode**, this knob is used to adjust the value of the function relevant to the currently selected Menu Page.

Displaying a Program Edit

When playing the K-Station it is useful to know whether the current selected sound has been modified in any way from the original program.

If any changes have been made to the program, (a knob has been tweaked or a button has selected a different function) an asterisk will appear in the display soon after the tweak or button press has been made. It will appear immediately to the left of the Program number when in **Program Mode**.



If the change is reversed (the control returned to its position as defined by the original Program), the asterisk will disappear.



Mode and Keypad Section

Original Values of settings

When adjusting a control it is useful to know how far away it is from the original value set by the program. Suppose the FILTER FREQ KNOB is fully clockwise (physically pointing to the 5 o'clock position) indicating a fully open setting (127).

If the filter setting of the Program being listened to is at the 2 o'clock position (say 101). A slight movement of the knob will result in the sound 'pinging' to a brighter sound. This is because the filter frequency will jump to a maximum (127) represented by the knob's current physical 5 o'clock position.

In order to 'home in' on the original program value, a vertical slider bar with a top and bottom arrow will move up and down the display.



Although not visible, the illustration above shows the vertical slider bar indicating that the knob is set too far above the Program's original value



In the real display, only tiny dot is visible next to the numeric value indicating that the knob must be turned anticlockwise to get nearer the Program's original value.



Rotating the knob anticlockwise shows the slider bar approaching the original value.



A further rotation of the knob locates the original value. This is indicated by slider moving down to cover the whole character next to the numeric value. The effect is that it is completely white.

Experiment with the controls and notice how the slider 'homes in' on the original value.

Mode and Keypad Section

This section contains buttons associated with Mode selection, writing Programs to memory, comparing Programs in memory against edited Programs and selecting Programs directly by three-digit entry.

PROGRAM Button

Pressing this button places the K-Station immediately into **Program Select Mode**. While in this mode, a new Program may be selected by using either the PAGE / PROGRAM buttons, the DATA / PROGRAM knob or by typing in a three digit entry by using the 0 - 9 Keypad / Menu Select buttons.

As soon as this button is pressed, Program Edit Mode or Menu Mode is cancelled.

MENUS Button

Pressing this button selects **Menu Mode**. In **Menu Mode**, the LED located above the MENUS button will light. If the K-Station was already in Menu Mode when the button was pressed, Menu Mode will be cancelled and the K-Station will return to **Program Select Mode**. **Program Select Mode** may be also be selected at any time by pressing the PROGRAM button

As soon as Menu Mode is entered, the display will either show the first Page of whatever Menu was accessed last time or the last selected page of the previously accessed Menu. (This depends on the setting of the Global function **New Menu Always Page 1** - See page 36). It is possible to immediately select a new Menu by pressing the appropriate 0 - 9 Keypad / Menu Select button.

Note : If an Effects Menu is currently being displayed, selecting a different Effect for editing (by pressing the Effects SELECT buttons located within the Effects Section), will result in the display showing settings relevant to the newly-selected Effect.

COMPARE Button

While this button is held down, the K-Station will recall the currently selected Program from its memory location, temporarily losing any edits you have made to the sound since it was originally selected.

Releasing the button restores the edit-buffer, bringing back any changes made to the sound since it was originally selected.

This feature is useful when it is desired to check the original contents of the current Program's memory location before over-writing it with the currently edited sound.

WRITE Button

Pressing this button starts the procedure for saving Programs into memory. This procedure is detailed in the section **Saving a Sound** on Page 4.

If however, this button is pressed while the Global Menu is currently active in **Menu Mode**, instead of saving the currently edited Program, the current settings of all Global settings will be saved into memory. (The display will briefly show 'GLOBALS SAVED')The next time the K-Station is switched on, these values will be remembered.

0 - 9 Keypad / Menu Select Buttons

While the K-Station is in **Menu Mode**, these buttons may be used to switch to a different Menu.

At all other times, pressing one of these buttons will initiate **Program Select Mode** and the K-Station will wait for the remaining digits of a three-digit entry to be entered so that the appropriate Program may be selected from memory.

*For this reason, it is important to make sure that the K-Station is already placed into **Menu Mode** before using these buttons to select a different Menu.*

This chapter details the many advanced features available on the K-Station. Most of these are found in the various Menus available when the K-Station is placed into **Menu Mode**. See page 14 for details on selecting Menu Mode.

Each of the various Menus available will now be discussed in detail.

The Oscillator Menu

To complement the front panel controls in the Oscillator section, there are many other functions located in the Oscillators Menu. This Menu is selected by pressing the keypad '1' button when the K-Station is in **Menu Mode**. Use the PAGE up/down buttons to scroll through the Menu functions available - See table below.

Page	Function	Display	Value
1	Voice Mode	OSC Mode	MONO...POLY 2
2	Unison Voices	OSC Unison	OFF...8
3	Unison Detune	OSC UniDtune	0...127
4	VCO Drift	OSC VcoDrift	0...127
5	Preglide Semitones	OSC Preglide	-12...12
6	Portamento Mode	OSC Porta	EXP-LIN
7	Start Phase	OSC Start Ph	OFF...14
8	Osc 1 -2 Sync	OSC 12 Sync	OFF-ON
9	Osc 2 - 3 FM Manual Level	OSC 23FM Lev	0...127
10	Osc 2 - 3 FM Env Amt	OSC 23FM Env	-64...63

Voice Mode (Menu Page 1)

This setting determines if the Program plays polyphonically or monophonically.

Voice Mode	
MONO	Mono No Auto Glide
MONO AG	Mono with Autoglide
POLY 1	Normal Poly Mode
POLY 2	Poly - no note layering

When set to **MONO** or **MONO AG**, the Program plays monophonically (ie only one note can be sounded at any one time). If a chord is played on the keyboard, it will be noticed that as each individual note is released, the note sounding will revert back to the nearest played note.

The **MONO AG** setting enables 'Auto glide' (portamento) to be triggered whenever a note is played on the keyboard *before* the previously held down note has been released (legato playing). Using 'Auto glide' in this way can greatly add expressiveness to a Program. It is especially effective when applied to lead type sounds.

The monophonic settings are often useful when replicating sounds in the 'real world' which would normally be played monophonically, for example a bass guitar.

As their name implies, the **POLY 1** and **POLY 2** settings allow polyphonic operation.

POLY1 allows successive playing of the same note(s) to be 'stacked' together, gradually producing a louder sound texture as the note(s) are repeatedly played.

With **POLY2**, if the same note(s) are played repeatedly, they will use the same synthesizer voices as used previously, thus avoiding the 'stacked note' effect.

Unison Voices (Menu Page 2)

Unison allows more than one voice to be used for each note played on the keyboard. This effect is useful when a very thick sound is required. The K-Station allows up to eight voices to sound layered one on top of another when just a single note is played.

To listen to the effect, select Page 2 in the Oscillator Menu, turn the DATA knob clockwise until the display shows 2. Play a note and listen to the sound. It will become thicker sounding. Increasing the number of

notes to a maximum of 8 will result in very dense sounding textures. Note: As more voices are assigned to Unison, the available polyphony will reduce accordingly. For example, using 8 voices in Unison mode will result in just one note of polyphony being available!

Unison Detune (Menu Page 3)

Unison Detune is used in conjunction with Unison Voices as described above. When using more than one voice per note, the Unison detune amount sets how much each voice is detuned relative to the others. Adjust the amount until the desired effect is heard.

VCO Drift (Menu Page 4)

Controls the amount of tuning drift for the Oscillators. Setting a modest value, 10 for example will cause each Oscillator to slowly drift fractionally out of tune. Classic Analogue Synthesizers were known to gradually go out of tune as the internal circuits heated up. This 'instability' actually helped to give them their own unique character!

Preglide Semitones (Menu Page 5)

A Preglide is applied to the pitch of the Oscillators starting at a pitch determined by the Preglide amount in semitones. Gliding up from a pitch occurs when the display indicates between -12 to -1, and gliding down from a pitch occurs when the display indicates between 1 to 12. At a setting of 0, no preglide is applied.

The time it takes to complete the Glide is determined by the PORTAMENTO knob on the front panel. The Preglide is triggered with every note received.

Portamento Mode (Menu Page 6)

Determines the type of curve applied when PORTAMENTO is used. Two types of curve are available, Exponential and Linear. Linear Portamento sweeps through note intervals at a constant rate. When Exponential Portamento is used, the rate of sweep decreases throughout the note sweep's duration.

Start Phase (Menu Page 7)

When synthesizing percussive or plucked type sounds, there is a lot of detailed waveform information at the beginning of the sound. It is often useful to have the Oscillator wave start in *exactly* the same place every time a key is pressed.

The start phase option allows the precise starting point of the Oscillator wave to be determined. At a setting of 0, the wave will start at zero Degrees. Each increment on the display shifts the start point of the wave approximately 24 degrees. The wave will start at a random phase when set to OFF.

Osc 1 - 2 Sync (Menu Page 8)

This function provides a way of producing interesting, piercing, metallic sounds. It does this by using the frequency of Oscillator 1 to periodically restart the waveform used by Oscillator 2. This technique is known as Oscillator Sync. Set this to **ON** to activate Sync.

It should be remembered that the *frequency* of a waveform corresponds to the number of waveform peaks (cycles) over a given period of time. The frequency also determines the Oscillator's pitch. Therefore if Oscillators 1 and 2 are detuned from each other, Oscillator 2's waveform will be periodically interrupted and started again from the beginning of the waveform cycle every time Oscillator 1's waveform begins a new cycle. The following diagram illustrates this.

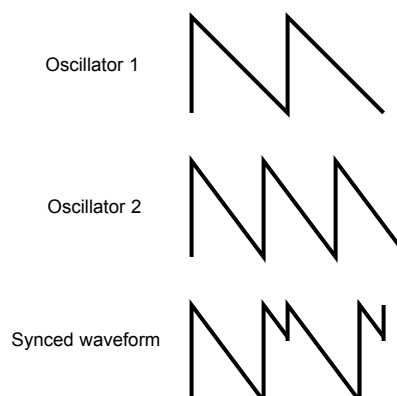

The Oscillator Menu (FM Synthesis)

It can be seen that the resulting synced waveform has subsequently been modified into a different shape. Altering a waveform's shape in this way introduces new harmonics into the sound which gives the resulting waveform its distinctive synced sound qualities.

It should be realised that the greater the difference in tuning between the Oscillator waveforms, the more pronounced the sync effect will become, since more drastic changes will be made to the final synced waveform. Changing the pitch of one of the Oscillators during the duration of a note (for example, modulated by an LFO) will add a dynamic quality to the synced sound.

FM Synthesis.

The next two menu options allow sounds based on FM (Frequency Modulation) synthesis to be created. Before looking at the operations of these controls, a little explanation of FM synthesis follows.

Earlier in this manual, the basics of subtractive synthesis were introduced. Terms such as harmonics, timbre, waveforms and oscillators became familiar.

FM Synthesis is the technique of using *one waveform to Frequency Modulate - FM- another to produce a resultant more harmonically complex waveform.*

The following diagram illustrates that the higher the modulation between the Modulating wave and the Carrier wave, the more the waveform changes.

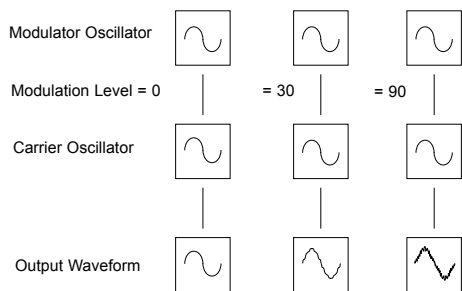

In the illustration, the Oscillators are producing Sine waves. It is the *change* in harmonics over time that makes a sound interesting to our ears. In FM synthesis, an envelope generator is inserted between the modulator and carrier waveforms so that there is control over of how much of the frequency modulation is taking place with respect to time. Adding this envelope constructs the basic FM building block as illustrated below.

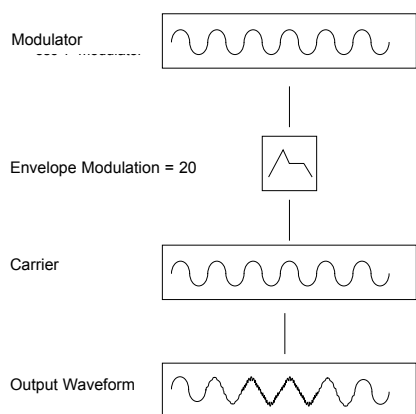

It can be seen that the output waveform begins, being identical to the carrier, but becomes more complex (harmonics are added) as the amount of FM modulation increases via the envelope. It then returns to a simple wave again as the envelope decays.

The timbre of the Waveform is changing with time. This is the opposite of subtractive synthesis where a *low pass Filter* is used to *remove harmonics*.

To complete a simple synthesizer, a further envelope is added to control the output volume.

The complete FM building block is illustrated below.

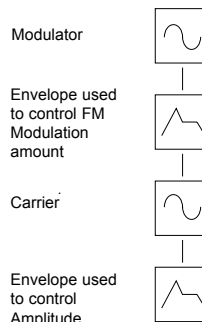

OSC 2 is able to FM OSC 3 via a dedicated FM envelope. *It is important that it is realized that this Envelope is used only for FM purposes and is not one of the Envelopes available on the K-Station's front panel.*

The diagram below shows in block diagram format how the K-Station can produce FM sounds.

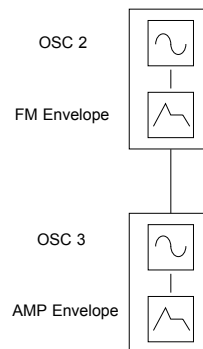

The easiest way to be totally familiar with FM is to take one of the factory preset FM sounds, for example Bank 2 - 09 (Sound 209), a bell sound and to experiment by modifying the various FM settings.

OSC 2 - 3 FM Manual Level (Menu Page 9)

Controls the amount that Oscillator 3 is directly Frequency Modulated by Oscillator 2. Whilst playing a note, adjust this value by using the DATA knob. Notice that increasing amounts of modulation level make the sound more metallic.

OSC 2 - 3 FM Envelope Amount (Menu Page 10)

Many sounds have complex harmonic movements at the start of the sound. Introducing envelope modulation from an envelope with a fast attack and decay time to control the FM amount will simulate this fast changing harmonic effect.

Adjust this value by using the DATA knob. Notice how the 'spit' at the beginning of the sound may be accentuated. Experiment with Oscillator 2's pitch using the OCTAVE button and the SEMITONE and DETUNE knobs.

Adjusting the FM Envelope Attack and Decay Times

Changing the various FM Envelope values is done from within the Envelopes Menu. See Page 27 for details.

The Filter Menu

To complement the front panel controls in the Filter section, there are other functions located within the Filter Menu. This is selected by pressing the keypad '2' button while the K-Station is in **Menu Mode**. Use the PAGE up/down buttons to scroll through the Menu functions available - See table below.

Filter Menu			
Page	Function	Display	Value
1	Q Normalise	FILT Q Norm	0...127
2	Overdrive	FILT Drive	0...127

Q Normalise (Menu Page 1)

This value controls the Resonance Normalise. At zero, when resonance is applied, the main audio signal will remain at normal levels. Adjusting clockwise will reduce the signal level in relation to the resonance level.

This feature enables the Filter to emulate many of the classic Filters such as the Moog type, Oberheim type and Roland TB303* type.

Overdrive (Menu Page 2)

This value of this function controls how much the filter is overdriven. When used in large amounts it will have the effect of making the sound richer and slightly distorted.

The LFOs Menu

To complement the front panel controls in the LFO section, there are many other functions located within the LFOs Menu. This is selected by pressing the keypad '3' button while the K-Station is in **Menu Mode**. Use the PAGE up/down buttons to scroll through the Menu functions available - See table below.

LFO Menu			
Page	Function	Display	Value
1	LFO1 Delay Triggering	LFO1 DelTrig	SGL-MLT
2	LFO1 Keysync	LFO1 Keysync	OFF-ON
3	LFO1 Keysync Phase Offset	LFO1 Ksync PhO	OFF-ON
4	LFO1 Common to all Voices*	LFO1 Common	OFF-ON
5	LFO1 Sync Rate	LFO1 Sync	OFF...12bars
6	LFO2 Delay Triggering	LFO2 DelTrig	SGL-MLT
7	LFO2 Keysync	LFO2 Keysync	OFF-ON
8	LFO2 Keysync Phase Offset	LFO2 Ksync PhO	OFF-ON
9	LFO2 Common to all Voices*	LFO2 Common	OFF-ON
10	LFO2 Sync Rate	LFO2 Sync	OFF...12bars

* When common, keysync becomes global sync

LFO Delay Triggering (Menu Pages 1 & 6)

When the Voice mode is set to any of the Mono options (see Page 23), different LFO delay settings are available for legato playing styles (notes overlapping).

When the first note of a musical phrase is played, it might be desirable to have an initial delay on the LFO. (If the LFO is routed to pitch modulation, a vibrato effect would be introduced after the delay time). For the remaining legato notes, a non interrupted vibrato might be required. Setting this to **SGL** (single) achieves this.

Setting this to **MLT** (Multi) sets the LFO delay to apply to every note played.

LFO Keysync (Menu Pages 2 & 7)

Each LFO waveform may be restarted every time a key is pressed. For example, if a siren type sound effect was required, an LFO using a sawtooth wave would be set to positively modulate pitch. Each time a new key is pressed, the pitch would climb from the same point (because the LFO waveform would be restarted) rather than being at an undetermined pitch position.

Note : If the **LFO Common To All Voices** function (detailed below) is set to **ON** for the LFO, *altering this value will have no effect*. How a keysync is applied to the LFO is determined by the changing the **Global Sync Mode** settings (found in the Global Menu). See Page 35 in the **Advanced Features** chapter for details.

LFO Keysync Phase Offset (Menu Pages 3 & 8)

This setting provides an alternative point in the LFO's waveform cycle where the waveform will be restarted from when **LFO Keysync** is set to **ON**. To hear the difference, set a slow LFO to modulate Oscillator pitch modulation and experiment with different LFO waveforms and **LFO Keysync Phase Offset** settings.

LFO Common To All Voices (Menu Pages 4 & 9)

Each of the eight voices have two LFO's - sixteen in total. The eight LFOs designated LFO 1 (one per voice) may be 'phase' locked together and similarly the eight LFO's designated LFO 2 may be locked.

To illustrate this, assume the LFO waveform is a triangle wave and at a specific moment in time all eight are at the beginning of a the rising portion of the wave. At a later point in time all will be at the beginning of the falling portion of the wave. If this waveform is applied to pitch, when a number of notes are played simultaneously, the pitch of all the notes will rise and fall at precisely the same time.

If the LFO is not locked, then each wave will be at a random position relative to the others. In this pitch modulation example, the pitch of all the notes will be changing 'out of synchronization' with others.

Imagine a String section of eight violin players. With the LFO locked and the LFO being used to create a vibrato, all eight of the string players would have the bow in exactly the same position. This obviously does not occur in a real string section and if it did the sound would be very unusual. In reality, each player's bow would be in a different position which gives the strings a 'chorus' type sound. To simulate the string section the LFOs would not be locked.

Setting this to **ON** will 'lock' the LFO.

Note : When **LFO Common To All Voices** is set to **ON**, changing the setting of the **LFO Keysync** function will have no effect. Instead, how a keysync is applied to the LFO is determined by the setting of the **Global Sync Mode** value (found in the Global Menu). See Page 35 in the **Advanced Features** chapter for details.

LFO Sync Rate (Menu Pages 5 & 10)

Both LFOs may be synchronized to MIDI Clock. As an example, a very pleasing audio effect may be achieved when an LFO is modulating the filter cut off frequency and this is synchronized to the tempo of a musical piece.

To synchronize an LFO, alter this value until the desired musical timing is displayed. See the synchronization table below for details on how these settings relate to the MIDI Clock.

LFO's Synchronisation to MIDI Clock table					
Display	MIDI Clocks	Synchronised to	Display	MIDI Clocks	Synchronised to
OFF	-	Manual Rate			
32nd T	2	32nd Triplet	1bar D	144	1.5 Bars
32nd	3	32nd	2 bars	192	2 Bars
16th T	4	16th Triplet	4bar T	256	4 Bar Triplet
16th	6	16th	3 bars	288	3 Bars
8th T	8	8th Triplet	5bar T	320	5 Bar Triplet
16th D	9	16th Dotted	4 bars	384	4 Bars
8th	12	8th	3bar D	432	4.5 Bars
4th T	16	4th Triplet	7bar T	448	7 Bar Triplet
8th D	18	8th Dotted	5 bars	480	5 Bars
4th	24	4th	8bar T	512	8 Bar Triplet
2nd T	32	2nd Triplet	6 bars	576	6 Bars
4th D	36	4th Dotted	7 bars	672	7 Bars
2nd	48	2nd	5bar D	720	7.5 Bars
1bar T	64	1 Bar Triplet	8 bars	768	8 Bars
2nd D	72	2nd Dotted	9 bars	864	9 Bars
1 bar	96	1 Bar	7bar D	1008	10.5 Bars
2bar T	128	2 Bar Triplet	12bars	1152	12 Bars

Be aware that if an LFO is synchronized to the MIDI Clock, the front panel LFO SPEED knob will have no effect on the LFO speed. The actual speed of the LFO will be determined instead by the tempo of the MIDI Clock signals being transmitted by a sequencer. Many sequencers do not transmit MIDI Clock messages at all when they are stopped.

Setting this function to **OFF** allows the LFO to run at its own speed, which can be controlled by setting the LFO SPEED knob, found on the K-Station's front panel

The Envelopes Menu

To complement the front panel controls in the Envelopes section, there are many other functions located in the Envelopes Menu. This is selected by pressing the keypad '4' button when the K-Station is in **Menu Mode**. Use the PAGE up/down buttons to scroll through the Menu functions available - See table below.

Envelope Menu			
Page	Function	Display	Value
1	Program Level dB	PROG Level	-12...12
2	Velocity to Amp Env Level	ENV Amp Vel	-64...63
3	Velocity to Mod Env Level	ENV Mod Vel	-64...63
4	Velocity to FM Env Level	ENV FM Vel	-64...63
5	Amp Envelope Triggering	ENV Amp Trig	SGL-MLT
6	Mod Envelope Triggering	ENV Mod Trig	SGL-MLT
7	FM Envelope Triggering	ENV FM Trig	SGL-MLT
8	FM Env Attack	ENV FM Attak	0...127
9	FM Env Decay	ENV FM Decay	0...127
10	Audio Input Triggering	ENV Aud Trig	OFF-ON
11	External Audio to Effects	ENV In to FX	OFF-ON

Program Level dB (Menu Page 1)

The value of this function adjusts the *program output level*. This is used to maintain a consistent volume level, avoiding distortion throughout all sound Programs. Delicate sounds (such as those which use just one Oscillator and closed filter settings) can be increased in volume using this control. Conversely, sounds that use all Oscillators and high polyphony (6 to 8 notes played at once), can be reduced in volume to avoid distortion. Using a mixing desk as a comparison, this control can be thought of as the *gain* or *trim* control for the channel.

If a sound appears to be distorting unintentionally, especially when complex chords are being played, reduce the value of this setting.

Velocity To Env Level (Menu Pages 2, 3 & 4)

These functions determine how the Amp, Mod and FM Envelopes respond to Velocity information.

Setting up a sound to make its volume respond to velocity

Select the second Page in the Envelopes Menu (ENV Amp Vel). Adjust the DATA knob. At a setting of zero, a soft key stroke will produce a sound at the same volume as a hard key stroke. At a maximum positive value (63) soft key strokes will be much quieter than hard key strokes. At a maximum negative value (-64), soft key strokes will be much louder than hard key strokes.

Setting up a sound to make its brightness or pitch respond to velocity

Select the third Page in the Envelopes Menu (ENV Mod Vel). Adjust the DATA knob. Turn the Filter FREQUENCY knob to a near zero setting or until the sound almost disappears. Turn the MOD ENV DEPTH knob in the Filter dB section to a maximum clockwise position.

In the Envelopes section, Set the MOD ENV ATTACK and SUSTAIN knob to zero and the DECAY knob to nearly full. While playing notes on the Keyboard, adjust the DATA knob. At a setting of zero there will be no effect on the brightness of the sound.

At maximum positive value (63), soft key strokes will produce a tone much softer than hard key strokes. At a maximum negative value (-64), soft key strokes will produce a tone much brighter sound than hard key strokes. To affect the pitch, adjust the MOD ENV knob in the Oscillator section.

Adjusting the Velocity Response of the FM Envelope

Select a factory preset FM sound (such as 209). Select the fourth page in the Envelopes Menu (FM Env modulation). Adjust the DATA knob. Notice how the FM effect at the start of the sound becomes dependent on how hard the keys are struck.

Envelope Triggering (Menu Pages 5, 6 & 7)

These functions only apply to a sound which has been set up to behave in a monophonic manner (see **Voice Mode** on Page 23).

When the Voice mode is set to any of the Mono options, different envelope triggering options are available for legato playing styles (notes overlapping).

When the first note of a musical phrase is played, it might be desirable to have both the Amp and Mod envelopes trigger. For the remaining legato notes, just the Mod envelope re-triggering would create the effect of the phrase becoming quieter and quieter.

When these are set to **SGL** (single), the appropriate Envelope will only be triggered when the first keyboard note is played. Any subsequent legato style key presses will not re-trigger the Envelope.

When set to **MLT** (multi), the appropriate Envelope will always re-trigger on each key press, regardless of the playing style used.

FM Env Attack (Menu Page 8)

When FM synthesis is being used (see Page 24), this value determines the FM Envelope's Attack time.

Note : The FM Envelope is used only for FM synthesis and should not be confused with the Amp or Mod Envelopes available on the K-Station's front panel.

FM Env Decay (Menu Page 9)

When FM synthesis is being used (see Page 24), this value determines the FM Envelope's Decay time.

Note : The FM Envelope is used only for FM synthesis and should not be confused with the Amp or Mod Envelopes available on the K-Station's front panel.

Audio Input Triggering (Menu Page 10)

The K-Station is capable of processing an external audio signal through its Filter and / or Effects section. However, it should be remembered that the Amplifier is controlled by the AMP ENVELOPE controls on the front panel. Unless the Amplifier has been triggered (usually by playing notes on the keyboard or from a sequencer), the Amplifier will be set at a zero volume level and no audio signal will be passed through it.

This is not a problem when the external audio signal is to be passed solely through the Effects Section (since the Effects come after the Amplifier in the K-Station's audio signal path). However, if it desired to process the external audio signal through the K-Station's Filter, it is often convenient to be able to automatically trigger the Amplifier and Mod envelopes whenever an external audio signal is present.

Setting this function to **ON** automatically triggers the Amp and Mod Envelopes (thus opening up the Amplifier) whenever the external audio signal strength reaches a certain *threshold* level. This feature ensures that it is not necessary to play the K-Station from its keyboard or a sequencer in order to hear the external audio signal processed through the Filter.

The setting of the threshold level (sensitivity to external audio strength) is done by adjusting the **Input Trigger Sensitivity** value found within the Global Menu. See Page 36 for details.

When the Envelopes are auto-triggered in this way, the K-Station actually 'plays' a default note of Middle C. If the Mixer levels of any of the three Oscillators are set above zero, a pitched element to the sound will be heard (pitched at Middle C) whenever the Amp Envelope is auto-triggered. To remove this, make sure each of the Oscillator Mix levels in the Mixer Section are set to zero.

See Page 35 for more details of using external audio signals with the K-Station.

External Audio To Effects (Menu Page 11)

This function determines where the external audio signal is fed into the K-Station's audio signal path. There are two possibilities.

1. Feeding External Audio Directly To The Effects

The external audio signal may be fed directly to the K-Station's Effects section, bypassing the Mixer, Filter and Envelopes. Once the input sensitivity has been set for the input device (see Page 36) turn the the DATA knob until the display shows **ON**. The external signal should now be heard at the outputs. It may now be processed by all of the various effects including the EQ Filter.

2. Feeding External Audio Through The Filter

Setting this function to **OFF**, feeds the external audio signal into the K-Station's Mixer and Filter section. In order to hear the filtered signal, repeatedly press the SOURCE button in the Mixer section until the EXT INPUT LED lights and turn up the LEVEL knob. The K-Station's Amplifier also needs to be triggered by the Amp Envelope. This is done either by playing a note on the K-Station's keyboard, playing in a MIDI note message from a sequencer, or setting the Amp Envelope to auto-trigger when an external audio signal is present. See the function **Audio Input Triggering** described above for details on how to do this.

Once an external audio signal has passed through the K-Station's Filter, it can still be processed by the Effects section in the same manner as any other audio source (Oscillator waveforms etc.).

See Page 36 for more details of using external audio signals with the K-Station.

The Effects Menus - The Delay Menu

The Effects Menus

To complement the front panel controls in the Effects section, there are many other functions located within the Effects Menus. These are selected by pressing the keypad '5' button when the K-Station is in **Menu Mode**.

The Effects Menus comprise of seven separate sub-Menus (one for each different type of effect available on the K-Station). The actual sub-Menu accessed will be determined by whichever Effect type is currently selected by the SELECT buttons within the Effects Section.

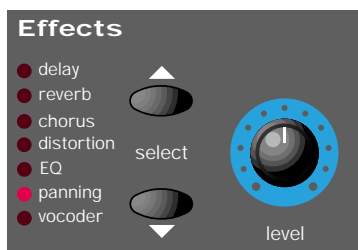

In an Effect sub-Menu, it is also possible at any time, to switch instantly to a new sub-Menu relating to a different effect, simply by selecting the effect using the Effects SELECT buttons.

The Delay Menu

The comprehensive Delay effects processor has many programmable functions. These may be edited to create the desired delay effect for a particular sound and saved along with the sound. Use the PAGE up/down buttons to scroll through the Menu functions available - See table below.

Page	Function	Display	Value
1	Time	DEL Time	0...127
2	Feedback	DEL Feedback	0...127
3	Sync Time	DEL Sync	OFF...2 bars
4	Stereo Width	DEL St Width	0...127
5	Left/Right Time Ratio	DEL L/R Ratio	1/1...O/1
6	Wheel Level	DEL Wheel	-64...63

Time (Menu Page 1)

Controls the amount of time it takes for the delayed signal to be heard after the original signal.

Feedback (Menu Page 2)

Controls how much of the delayed signal is fed back into the delay input. No feedback produces a slapback echo effect, just one delayed sound with no repeats. Small amounts of feedback produce repeated sounds resulting in a multiple echo effect. Large amounts of feedback produces infinite echoes.

Sync Time (Menu Page 3)

Enables the time of the Delay repeats to be synchronized to the tempo of a song.

The following table gives the range of synchronization values available.

Delay Synchronisation to MIDI Clock table

Display	MIDI Clocks	Synchronised to
OFF	-	Manual Rate
32nd T	2	32nd Triplet
32nd	3	32nd
16th T	4	16th Triplet
16th	6	16th
8th T	8	8th Triplet
16th D	9	16th Dotted
8th	12	8th
4th T	16	4th Triplet
8th D	18	8th Dotted
4th	24	4th
2nd T	32	2nd Triplet
4th D	36	4th Dotted
2nd	48	2nd
1bar T	64	1 Bar Triplet

When a sync interval is selected, the tempo of the Delay is controlled by the Arpeggiator's TEMPO knob when **MIDI Clock Source** is set to **INT**, or by the external sequencer's tempo when **MIDI Clock Source** is set to **EXT**. See Page 35 for setting the Global **MIDI Clock Source** from **INT** to **EXT** or vice versa

When controlling the Delay **Sync Time** from a sequencer, it is important to ensure that the sequencer is transmitting MIDI Clock messages. Consult the sequencer manual for details.

Note : When the **Sync Time** function is set to **OFF**, the timing of the delay repeats will be controlled by the setting of the **Time** function (Menu Page 4). Any incoming MIDI clock messages or Arpeggiator TEMPO settings will be ignored by the Delay effect.

Stereo Width (Menu Page 4)

This sets the Stereo spread between the long and short Delay times. With a width setting of zero, both delays appear in the middle of the stereo field (Mono). At maximum width setting, the longer delay will appear on one output and the shorter on the other, producing a dramatic stereo effect.

Left / Right Time Ratio (Menu Page 5)

Automatically adjusts the ratio of the longest delay time and the shorter delay time into timings that are musically useful.

Delay Ratios
Left/Right
1/1
4/3
3/4
3/2
2/3
2/1
1/2
3/1
1/3
4/1
1/4
1/OFF
OFF/1

Use the DATA knob to select the most suitable ratio. A Simple, equal 1 to 1 ratio is the first entry in the table. This setting sends a delay of equal time to the left and right output channels. The number in the left column of the table indicates the ratio of the delay time that will be in the left channel versus the number in the right column.

For example, if a delay of twice the time is required in the left channel compared to the right, select the **2/1** option. The final **1/OFF** and **OFF/1** options will result in no delay being heard in the channel indicated by the 'OFF'. Note: Selecting a 1/1 ratio will produce a mono effect regardless of the Stereo width setting since the timing of the echos are equal.

Wheel Level (Menu Page 6)

Sets how much the movement of the K-Station's Modulation wheel will introduce the delay effect.

The Reverb Menu

The Reverb Effect is an electronic simulation of a room or building that is acoustically reflective.

When a sound is made in a room or large building, there are sound reflections from all directions. When a Reverb effect is applied, it is these reflections of the sound that are being added.

Use the PAGE up/down buttons to scroll through the Menu functions available - See table below.

Reverb Menu			
Page	Function	Display	Value
1	Type	REV Type	CHAMBER...G HALL
2	Decay Time	REV Decay	0...127
3	Wheel Level	REV Wheel	-64...63

Type (Menu Page 1)

Different types of rooms and halls have different acoustics, therefore different Reverb characteristics. The K-Station's Reverb processor features six different Reverb types. These range from a small room to a large hall.

Reverb Types	
CHAMBER	Echo Chamber
S ROOM	Small Room
L ROOM	Large Room
S HALL	Small Hall
L HALL	Large Hall
G HALL	Grand Hall

Turn the DATA knob to experiment with different types of Reverb, noting how different 'rooms' affect the acoustic properties of the sound.

Decay Time (Menu Page 2)

This is the time it takes for the Reverb to die away after the original sound has decayed. Very acoustically reflective rooms (like those with metal or glass surfaces) tend to have long decay times and non reflective rooms have short ones.

Wheel Level (Menu Page 3)

Sets how much movement of the K-Station's Modulation wheel will introduce the Reverb effect.

The Chorus Menu

This effect was originally designed to simulate the sound of many people singing together (hence the name Chorus) in contrast to a single voice. Instrumentally, consider the sound of a 12 string guitar compared to a 6 string guitar. The very slight detuning of the individual strings actually gives a richer quality to the sound.

Chorus is an effect produced by mixing a continuously delayed version of the audio signal back with the original. The timing of the delayed version is very small and is controlled by the Chorus's own internal LFO (not to be confused with the two LFOs available on the K-Station's front panel). The characteristic swirling Chorus effect is the result.

The K-Station's Chorus is also capable of behaving as a Phaser. The way a Phaser works is in fact entirely different to the Chorus. A portion of the audio signal is split off and phase shifted at certain frequencies. It is then mixed back with the original signal to generate the characteristic swishing effect.

The functions available in the Chorus Menu are :

Chorus Menu			
Page	Function	Display	Value
1	Type	CHOR Type	CHORUS-PHASER
2	Rate	CHOR Rate	0...127
3	Sync Rate	CHOR Sync	OFF...12bars
4	Mod Depth	CHOR Mod Dep	0...127
5	Mod Centre	CHOR Centre	-64...63
6	Feedback	CHOR Feedbak	-64...63
7	LFO Sync Initial Position	CHOR Init Pos	OFF...RGT
8	Wheel Level	CHOR Wheel	-64...63

Type (Menu Page 1)

Determines whether the K-Station's Chorus is behaving as a standard Chorus or as a Phaser.

Rate (Menu Page 2)

Controls how fast the dedicated Chorus LFO is oscillating. A fairly slow speed is recommended. Higher speeds tend to introduce a vibrato like quality to the sound.

Note : The dedicated Chorus LFO should not be confused with the two LFOs available on the K-Station's front panel.

Sync Rate (Menu Page 3)

Similar to Delay Sync, the Chorus internal LFO may be synchronized to internal or external MIDI clock tempo.

The available Sync resolutions are :

Chorus Synchronisation to MIDI Clock table					
Display	MIDI Clocks	Synchronised to	Display	MIDI Clocks	Synchronised to
OFF	-	Manual Rate			
32nd T	2	32nd Triplet	1bar D	144	1.5 Bars
32nd	3	32nd	2 bars	192	2 Bars
16th T	4	16th Triplet	4bar T	256	4 Bar Triplet
16th	6	16th	3 bars	288	3 Bars
8th T	8	8th Triplet	5bar T	320	5 Bar Triplet
16th D	9	16th Dotted	4 bars	384	4 Bars
8th	12	8th	3bar D	432	4.5 Bars
4th T	16	4th Triplet	7bar T	448	7 Bar Triplet
8th D	18	8th Dotted	5 bars	480	5 Bars
4th	24	4th	8bar T	512	8 Bar Triplet
2nd T	32	2nd Triplet	6 bars	576	6 Bars
4th D	36	4th Dotted	7 bars	672	7 Bars
2nd	48	2nd	5bar D	720	7.5 Bars
1bar T	64	1 Bar Triplet	8 bars	768	8 Bars
2nd D	72	2nd Dotted	9 bars	864	9 Bars
1 bar	96	1 Bar	7bar D	1008	10.5 Bars
2bar T	128	2 Bar Triplet	12bars	1152	12 Bars

When a sync interval is selected, the tempo of the Chorus LFO is controlled by the Arpeggiator's TEMPO knob when **MIDI Clock Source** is set to **INT**, or by the external sequencer's tempo when **MIDI Clock Source** is set to **EXT**. See Page 35 for information on how to change the Global **MIDI Clock Source**.

The Chorus Menu - The Distortion Menu

When controlling the Chorus **Sync Rate** from a sequencer, it is important to ensure that the sequencer is transmitting MIDI Clock messages. Consult your sequencer manual for details.

Note : When the **Sync Rate** is set to **OFF**, the timing of the Chorus sync will be controlled by the setting of the **Rate**. Any incoming MIDI clock messages or Arpeggiator TEMPO settings will be ignored by the Chorus effect.

Mod Depth (Menu Page 4)

The Chorus has its own LFO which is continuously changing the delay time. **Mod Depth** sets how much of the fixed delay time is being modulated. Large amounts of modulation will produce a more noticeable effect. Moderate amounts are recommended.

Note : The dedicated Chorus LFO should not be confused with the two LFOs available on the K-Station's front panel.

Mod Centre (Menu Page 5)

The Stereo Chorus can actually be thought of as two continuously variable delays. The delay variations are being controlled by the Chorus dedicated LFO. The LFO is constantly moving the two delay amounts from minimum to maximum. When one delay is at max, the other is at min (hence the stereo effect).

The **Mod Centre** function moves the middle point between the Min and Max values. Experiment with this control for the desired effect.

Feedback (Menu Page 6)

This function controls how much of the delayed signal is fed back to the input of the Chorus generator. The Chorus effect benefits from low levels of feedback. When acting as a Phaser (see the Chorus **Type** setting on Page 29), the effect often requires higher levels of feedback.

LFO Sync Initial Position (Menu Page 7)

As well as being able to synchronize to MIDI clock (tempo), the dedicated Chorus LFO may have its initial position set after a specific MIDI event is received (see the **Global Sync Mode** function on Page 35).

The initial positions available are shown in the table above. For exam-

Chorus LFO Sync Initial Pos

OFF	Off
LFT	Left
MID	Centre
RGT	Right

ple, if the Chorus initial position sync is set to **RGT**, after an appropriate MIDI event, the Chorus effect will move from the right to the left.

Wheel Level (Menu Page 8)

This sets how much movement of the K-Station's Modulation wheel will introduce the Chorus effect.

The Distortion Menu

Distortion is an effect commonly used by Guitar players. However, it is now increasingly used in the production of modern Dance music. The Distortion effect gives the sound a hard edged, distorted and dirty kind of quality. Use the PAGE up/down buttons to scroll through the Menu functions available - See table below.

Distortion Menu			
Page	Function	Display	Value
1	Level Compensation	DIST Comp	0...127
2	Wheel Level	DIST Wheel	-64...63

Level Compensation (Menu Page 1)

If distortion is added to a sound, it will tend to get louder. In order to contain or compress the sound back to a level which is consistent with other programs, use this function which compensates for the perceived added loudness of a sound when Distortion is added.

Wheel Level (Menu Page 2)

This function determines how much movement of the K-Station's Modulation wheel will introduce the Distortion effect.

The EQ Menu

Contained in the Effects section is an EQ (Equalisation) Filter which can boost or cut high (treble) or low (bass) frequencies in a similar manner to the 'tone' controls often found on domestic hi-fi units.

As well as being able to boost low or high frequencies, the final output EQ Filter may be used to create automatic sweeps of EQ and filtering. EQ processing may be synchronized to tempo and locked to musical timings from 32nd triplets through to several bars.

Use the PAGE up/down buttons to scroll through the Menu functions available - See table below.

EQ Menu			
Page	Function	Display	Value
1	Frequency	EQ Freq	0...127
2	Mod Depth	EQ Mod Dep	0...127
3	Mod Rate	EQ Mod Rate	0...127
4	Sync Mod Rate	EQ Sync	OFF...12bars
5	LFO Sync Initial Position	EQ Init Pos	OFF...HI

Frequency (Menu Page 1)

The EQ frequency set point determines where in the sound spectrum the boost or cut occurs. The **Frequency** point may be moved anywhere from very low frequencies (0 = less than 10Hz) to very high frequencies (127 = above 20,000Hz)

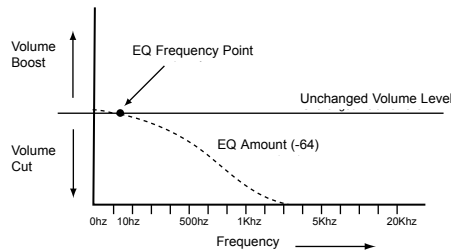

EQ Frequency set to 5

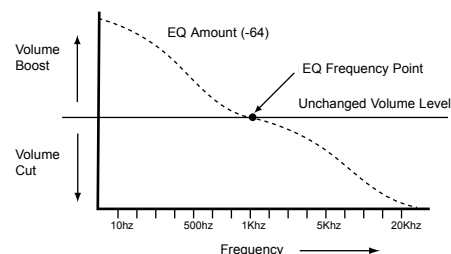

EQ Frequency set to 50

To change the EQ frequency, select Page 1 in the EQ Menu. Adjust the DATA knob for the desired EQ frequency.

Mod Depth (Menu Page 2)

The real power of the EQ filter is the ability to move the EQ **Frequency** set point automatically with the dedicated LFO. This control dictates how intense the movements are from the LFO. Any amount of depth will result in EQ changes at the rate determined by the EQ rate control.

Note : The dedicated EQ LFO should not be confused with the two LFOs available on the K-Station's front panel.

To change the depth, select Page 2 in the EQ Menu. Adjust the DATA knob for the desired EQ Depth.

Mod Rate (Menu Page 3)

Determines the rate (speed) of the dedicated EQ LFO. This LFO is able to modulate the EQ frequency (see **Mod Depth** above). To change the rate, select Page 3 in the EQ Menu. Rotate the DATA knob clockwise to increase the rate and anticlockwise to decrease the rate. Note : The dedicated EQ LFO should not be confused with the two LFOs available on the K-Station's front panel.

Sync Mod Rate (Menu Page 4)

The rate (speed) of the dedicated EQ LFO may be locked to the tempo of the musical piece to allow auto EQ Filtering effects. The following table describes the musical timings available.

EQ Synchronisation to MIDI Clock table					
Display	MIDI Clocks	Synchronised to	Display	MIDI Clocks	Synchronised to
OFF	-	Manual Rate			
32nd T	2	32nd Triplet	1bar D	144	1.5 Bars
32nd	3	32nd	2 bars	192	2 Bars
16th T	4	16th Triplet	4bar T	256	4 Bar Triplet
16th	6	16th	3 bars	288	3 Bars
8th T	8	8th Triplet	5bar T	320	5 Bar Triplet
16th D	9	16th Dotted	4 bars	384	4 Bars
8th	12	8th	3bar D	432	4.5 Bars
4th T	16	4th Triplet	7bar T	448	7 Bar Triplet
8th D	18	8th Dotted	5 bars	480	5 Bars
4th	24	4th	8bar T	512	8 Bar Triplet
2nd T	32	2nd Triplet	6 bars	576	6 Bars
4th D	36	4th Dotted	7 bars	672	7 Bars
2nd	48	2nd	5bar D	720	7.5 Bars
1bar T	64	1 Bar Triplet	8 bars	768	8 Bars
2nd D	72	2nd Dotted	9 bars	864	9 Bars
1 bar	96	1 Bar	7bar D	1008	10.5 Bars
2bar T	128	2 Bar Triplet	12bars	1152	12 Bars

When a sync interval is selected, the tempo of the EQ Filter sweep is controlled by the Arpeggiator's TEMPO knob when **MIDI Clock Source** is set to **INT**, or by the external sequencer's tempo when **MIDI Clock Source** is set to **EXT**. See Page 35 for information on changing the **Global MIDI Clock Source**.

When controlling the EQ **Mod Rate** from a sequencer, it is important to ensure that the sequencer is transmitting MIDI Clock messages. Consult your sequencer manual for details.

Note : When the **Sync Mod Rate** is set to **OFF**, the timing of the EQ sweeps will be controlled by the setting of the **Mod Rate**. Any incoming MIDI clock messages or Arpeggiator TEMPO settings will be ignored by the EQ effect.

LFO Sync Initial Position (Menu Page 5)

As well as being able to synchronize to MIDI clock (tempo), the dedicated LFO used to modulate the depth of the EQ may have its initial position set after a specific MIDI event is received (such as Program Change or Start Song - see the **Global Sync Mode** function on Page 35).

To change the EQ Initial position, select Page 5 in the EQ Menu. Use the DATA knob to select one of the initial positions shown in the table below.

EQ LFO Sync Initial Position	
OFF	Off
LOW	Low Freq
MID	Centre Freq
HI	High Freq

For example, if the desired position is to start moving upwards then set this function to **LOW**. After an appropriate MIDI event, the LFO wave will start to climb from this low position. Set to **MID** and it climbs from the centre of the waveform.

Note : The dedicated EQ LFO should not be confused with the two LFOs available on the K-Station's front panel.

Setting The EQ Amount

Setting of the EQ cut / boost amount at the EQ **Frequency** position is done by altering the LEVEL knob in the Effects section of the front panel. See Page 20.

The Panning Menu

The Panning Menu

The Panning function in the K-Station performs the same function as the Panning knob on a mixing console. It can be used to position a sound anywhere from left to right in the stereo field.

Changing the Pan Position of a sound

Ensure that Panning is selected by the SELECT buttons in the Effects section. Turn the Effects section LEVEL knob clockwise or anticlockwise to move the sound across the Stereo field.

Use the PAGE up/down buttons to scroll through the Menu functions available - See table below.

Pan Menu			
Page	Function	Display	Value
1	Mod Depth	PAN Mod Depth	0...127
2	Rate	PAN Rate	0...127
3	Sync Rate	PAN Sync	OFF...12bars
4	LFO Sync Initial Position	PAN Init Pos	OFF...RGT

Mod Depth (Menu Page 1)

The Panning effect has its own dedicated LFO (not to be confused with the two LFOs available on the K-Station's front panel) which can be used to automatically pan a sound backwards and forwards across the stereo field. This function controls the depth of this automatic panning effect.

When **Mod Depth** is set to zero, no automatic panning will be applied and the position of a sound in the stereo field will be static, being solely determined by the manual Pan position.

Rate (Menu Page 2)

This function controls the Panning LFO's speed. If the **Mod Depth** (see above) is set to a non zero value, the Panning LFO will move the sound from the Left to the Right at a speed determined by this **Rate** setting

Note : The Panning LFO should not be confused with the two LFOs available on the K-Station's front panel.

Sync Rate (Menu Page 3)

A very pleasing audio effect may be heard when the Panning effect is synchronized to the tempo of a musical piece. The following table describes the musical timings available.

Panning Synchronisation to MIDI Clock table					
Display	MIDI Clocks	Synchronised to	Display	MIDI Clocks	Synchronised to
OFF	-	Manual Rate			
32nd T	2	32nd Triplet	1bar D	144	1.5 Bars
32nd	3	32nd	2 bars	192	2 Bars
16th T	4	16th Triplet	4bar T	256	4 Bar Triplet
16th	6	16th	3 bars	288	3 Bars
8th T	8	8th Triplet	5bar T	320	5 Bar Triplet
16th D	9	16th Dotted	4 bars	384	4 Bars
8th	12	8th	3bar D	432	4.5 Bars
4th T	16	4th Triplet	7bar T	448	7 Bar Triplet
8th D	18	8th Dotted	5 bars	480	5 Bars
4th	24	4th	8bar T	512	8 Bar Triplet
2nd T	32	2nd Triplet	6 bars	576	6 Bars
4th D	36	4th Dotted	7 bars	672	7 Bars
2nd	48	2nd	5bar D	720	7.5 Bars
1bar T	64	1 Bar Triplet	8 bars	768	8 Bars
2nd D	72	2nd Dotted	9 bars	864	9 Bars
1 bar	96	1 Bar	7bar D	1008	10.5 Bars
2bar T	128	2 Bar Triplet	12bars	1152	12 Bars

When a sync interval is selected, the tempo of the Panning is controlled by the Arpeggiator's TEMPO knob when **MIDI Clock Source** is set to **INT**, or by the external sequencer's tempo when **MIDI Clock Source** is set to **EXT**. See Page 35 for information on changing the Global **MIDI Clock Source** setting.

When controlling the Panning **Rate** from a sequencer, it is important to ensure that the sequencer is transmitting MIDI Clock messages. Consult the sequencer manual for details.

When **Sync Rate** is set to **OFF**, the Panning effect will be at the rate determined by the Panning **Rate** setting. Any incoming MIDI clock messages or Arpeggiator TEMPO settings will be ignored by the Panning effect.

LFO Sync Initial Position (Menu Page 4)

As well as being able to be synchronized to a MIDI clock (tempo), the Panning LFO may have its initial position set after a specific MIDI event is received (see the **Global Sync Mode** function on Page 35).

Pan LFO Sync Initial Position

OFF	Off
LFT	Left
MID	Centre
RGT	Right

The initial positions are shown in the table above. For example, if the Panning initial position sync is set to **RGT** (Right), after an appropriate MIDI event has been received, the sound will begin in the right output audio channel and then move towards the left.

Note : The Panning LFO should not be confused with the two LFOs available on the K-Station's front panel.

The Vocoder menu

Vocoder sounds have recently returned to popularity and are being used more frequently in modern Pop and Dance music, typically to produce distinctive 'robot voice' type effects.

Activating The Vocoder

This is done by using the LEVEL knob found in the Effects section while the Vocoder is currently selected by the SELECT buttons. This control is also used to balance the various elements used to create the Vocoder effect. See Pages 21 in the **Main Features and Operation** section for full details and for a description of how the Vocoder operates.

Additional functions relating to the Vocoder are to be found in the Vocoder Menu. Use the PAGE up/down buttons to scroll through the Menu functions available - See table below.

Vocoder Menu			
Page	Function	Display	Value
1	Stereo Width	VOC St Width	0...127
2	Sibilance Level	VOC Sib Lev	0...127
3	SibilanceType	VOC Sib Type	HP-Noi

Stereo Width (Menu Page 1)

Determines how wide the stereo output of the vocoder will be. The 12 bands of the Vocoder are panned one by one to the left and to the right. Increasing the value moves the individual bands further away from the centre position.

Sibilance Level (Menu Page 2)

Determines the amount of sibilance there will be present in the final vocoded signal. Typically these are the 'S' and 'T' types of sounds heard in speech. Adding sibilance gives the Vocoder a more defined sound and helps make vocoded voices more intelligible.

Sibilance Type (Menu Page 3)

Determines if the vocoder uses real sibilance high-pass filtered from the modulator or artificially generates it using noise. When set to **HP**, a high pass filter is used to extract the sibilance from the modulator (Note : this will allow some of the modulator signal to be heard). When set to **NOI**, Noise is used to artificially generate the sibilance.

The Utilities Menu

This menu contains various utility functions associated with dumping data via MIDI, restoring memories and wheel calibration. The Utilities Menu is accessed by pressing the keypad '6' button while the K-Station is already in **Menu Mode**.

Use the PAGE up/down buttons to scroll through the Menu functions available - See table below.

Utility Functions Menu			
Page	Function	Display	Value
1	Transmit Midi Sysex Dump	Dump	CURR SOUND-GLOBAL DATA
2	Restore Factory Settings	Restore	ONE PROG-GLOBAL D
3	Calibrate Wheels	Calibrate	BEND-MOD
4	Display Contrast	Contrast	0...64

Transmit Midi Sysex Dump (Menu Page 1)

The K-station is capable of using MIDI System exclusive messages (often shortened to Sysex) to transfer 'dump' a record of its memory contents for storage in a MIDI device, usually a sequencer. Saving data in this way is useful for building up sound libraries or creating an emergency data backup in case of the K-Station's memories becoming accidentally over-written.

It is also possible to link two K-Stations or a K-Station and an A-Station together with a MIDI cable and use Sysex dumping as a means of directly transferring memory contents from one machine to the other.

To initiate a Sysex dump, select the desired option using the DATA

Transmit Midi Sysex Dump	
CURR SOUND	Current Sound (including edits)
PROG BANK 1	Program Bank 1
PROG BANK 2	Program Bank 2
PROG BANK 3	Program Bank 3
PROG BANK 4	Program Bank 4
ALL P BANKS	All Program Banks
GLOBAL DATA	Global Data

knob. Start the sequencer recording and press the WRITE button to start transmission of Sysex data. If the **CURR SOUND** option or **GLOBAL DATA** is selected then the display will flash DONE as confirmation that the transmission has taken place.

If **PROG BANK1** through **ALL P BANKS** is selected the display will indicate progress of transmission by indicating **DUMPING PROG XXX** (where XXX is the Program number).

Note : Some sequencers (such as Cubase) sometimes have Sysex messages filtered out as a default setting. If the sequencer appears not to have recorded the sysex dump into a track, check that the sequencer is not set to filter out Sysex messages. Consult the sequencer's manual for details.

Receiving a Sysex Dump

Once Sysex data has been stored in a sequencer track, the data can then be re-loaded into a K-Station by simply playing the sequencer track in the normal way.

If a single Sound is received via Sysex, it is important to realise that it is only *Program Edit Buffer* which has been changed. The newly-received sound can immediately be played on the K-Station's keyboard, but if the new sound is to be kept, it must be manually saved into a memory location in the normal way, similar to a manually edited Program.

When a whole bank of sounds or the Global settings are received via Sysex, the data is placed directly into the K-Station's memories. For this reason, it is important to make sure that the Global **Memory Protect** switch is set to **OFF** (see Page 35) before loading a whole bank of Programs or Global data, otherwise the dump will be rejected.

The Utilities Menu

Restore Factory Settings (Menu Page 2)

When originally shipped from the factory, the K-Station is supplied with two banks of 100 preset memories. However, it is possible to over-write these memory locations with new sounds or accidentally erase them.

This utility enables any of the preset memories to be restored back by reading the data from the K-Station's non-erasable ROM chip.

The **Restore Factory Settings** are shown in the table below and may be selected using the DATA/PROGRAM knob when in Menu Page 2.

Restore Factory Settings	
ONE PROG	One Program
ONE BANK	100 Programs from Factory Bank 1 or 2*
GLOBAL D	Global Data

Restoring a Single Factory Preset Sound - ONE PROG

When restoring a single Program, the restored Program will be placed into whatever Program is currently selected by the K-Station. If necessary, select the appropriate destination Program from within **Program Select Mode**, then re-enter **Menu Mode** and return to this Page of the Utilities Menu.

When the WRITE button is pressed, the K-Station will prompt for the Program number to be restored from ROM as displayed below.



The 'from' location is at the far right of the display and this may be altered using the DATA/PROGRAM knob. For ease of locating the desired sound, each factory preset may be auditioned using the keyboard as each new location selected. The Program number to be restored may also be selected using Numeric Keypad buttons. Note that it is only possible to select a restored Program from Banks 1 or 2. (Programs 100 - 299)

Pressing the WRITE button again writes the restored Program into the destination Program as indicated by the display. The display will flash 'DONE' and the K-Station will return to **Program Select Mode**

Note : It is only possible to restore Programs if the Global **Memory Protect** switch is turned **OFF** (see Page 35).

Note : It is possible to abandon the restore procedure at any point by pressing the PROGRAM button.

Restoring a whole Bank of Factory Preset Sounds

When restoring a whole Bank of sounds, the Bank of 100 sounds will be written to whatever Bank the currently selected Program belongs to. If necessary, select an appropriate destination Program Bank (any Program within a Bank will select its Bank) from within **Program Select Mode**, then re-enter **Menu Mode** and return to this Page in the Utilities Menu.

When the WRITE button is pressed, the K-Station will prompt for the Bank number to be restored from ROM as displayed below.



Select the Bank to restore to by using the DATA knob. Note that it is only possible to select Banks 1 or 2 as the restored Banks.

Pressing the WRITE button again restores the whole Bank of 100 Programs into the destination Bank (the Bank used by the currently selected Program in **Program Select Mode**). The display will flash 'DONE' and the K-Station will return to **Program Select Mode**.

Note : It is only possible to restore Programs if the Global **Memory Protect** switch is turned **OFF** (see Page 35).

Note : It is possible to abandon the restore procedure at any point by pressing the PROGRAM button and returning to **Program Select Mode**.

Restoring Global Data

When this option is selected, press the WRITE button to restore all Global Data. The display will flash 'DONE' and the K-Station will return to **Program Select Mode**

Note : It is only possible to restore Global Data if the Global **Memory Protect** switch is turned **OFF** (see Page 35).

Calibrate Wheel (Menu Page 3)

This utility allows the K-Station's Pitch Bend and Modulation wheels to be calibrated for optimum performance. To calibrate the wheels, push the bend wheel (outermost wheel) fully forwards and then fully backwards. The left hand side of the display will show a value of BEND 0 when the wheel is fully backwards and BEND 256 when the wheel is fully forwards. Repeat this forward and backwards movement for the other (Modulation) wheel. The display will show MOD 0 through to MOD 128. Finally press the WRITE key once.

A brief message 'CAL WHEEL SAVED' will flash on the screen. The K-station will then return to PROGRAM mode

The wheel calibration data is stored in memory along with all the Global data, so once this has been done, it will not usually become necessary to calibrate the wheels again.

Display Contrast (Menu Page 4)

Rotate the DATA/PROGRAM knob to adjust the contrast of the K-Station's display until it is easy and comfortable to read.

The Global Menu

This menu is used to change various settings which remain constant regardless of which Program is currently selected. The Global Menu is selected by pressing the keypad '7' button when the K-Station is in **Menu Mode**. Use the PAGE up/down buttons to scroll through the Menu functions available - See table below.

Global Menu (not stored in programs)			
Page	Function	Display	Value
1	Memory Protection	Mem Protect	OFF-ON
2	Midi Receive Channel	Midi Rx Chan	1...16
3	Midi Transmit Channel	Midi Tx Chan	1...16
4	Keyboard Transmit Channel	Kbd Tx Chan	1...16
5	Master Tune Cents	Master Tune	-64...63
6	Local Control	Local Cntrl	OFF-ON
7	Midi Clock Source	Clock Source	INT-EXT
8	Midi Clock Input Status	Ext Clock In	-- / ON / bpm value
9	Global Sync Mode	Glob Sync	NOTE 1...SNG ST
10	Velocity Curve	Vel Curve	SOFT-HARD
11	Function Display Time*	Display Time	0...127
12	Prog Mode Display Control*	Disp Control	TIME-PERM
13	New Menu Always Page 1	NewMenu Page	OFF-ON
14	Input Sensitivity Range	InSens	LIN-MIC
15	Input Trim dB	InTrim	-10...20
16	Input Trigger Sensitivity	In Trig Sens	0...127
17	Octave Buttons Control	<<oct>> Kill	OFF-ON

* For display of control knob settings (not menu settings)

Memory Protect (Menu Page 1)

This is a safety switch, used to prevent accidental erasure of memories and loss of data. When set to **ON**, writing Programs or Global data into memory will be prevented, and a brief warning message shown on the K-Station's display.

It is recommended that Memory Protect is left **ON** unless Programs are being edited for storing into memory, or a System Exclusive dump from a sequencer is to be received.

Permanently saving any changes made to Global settings

Any changes made to the Global settings will remain valid only while the power to the K-Station is on. To permanently save any new settings, the Global Memory must be saved. To do this, press the WRITE button at any time that the Global Menu is active. A message **SAVING GLOBALS** will appear for a short period on the display. Once saved, even if the power is turned off, any new settings will be memorised.

NOTE: After permanently saving the Global settings, the currently selected Program will be the default Program after applying power.

MIDI Receive Channel (Menu Page 2)

Specifies the MIDI channel on which the K-Station will accept MIDI messages from a sequencer or other MIDI device.

MIDI Transmit Channel (Menu Page 3)

Specifies the MIDI channel used by the K-Station for transmitting MIDI information when knobs and switches are altered on the front panel.

Keyboard Transmit Channel (Menu Page 4)

Specifies which MIDI channel will be used for transmission whenever the K-Station's keyboard is played or the Pitch Bend or Modulation Wheels are moved.

This number would normally be set to the same MIDI channel as the **MIDI Transmit Channel**, but there may be circumstances (for instance in a live performance situation) where it would be desirable to set this to a different channel number.

Master Tune Cents (Menu Page 5)

Adjusts the master tuning of the K-Station. At the factory, this value will have been set to **0**. This setting of zero is equivalent to concert pitch tuning (middle C = 440 Hz).

Local Control (Menu Page 6)

This function can be thought of as a switch which when set to **OFF**, disconnects the front panel controls and keyboard from the K-Station's synthesizer engine.

Playing the keyboard or moving any of the K-Station's controls still results in the appropriate MIDI information being transmitted from the K-Station's MIDI OUT socket, but they will have no direct effect on the K-Station itself. *The K-Station will only be affected if the MIDI signals are routed back into the MIDI IN socket - probably by a sequencer.*

It is recommended that this is set to **ON** unless the full MIDI implications are appreciated of turning this **OFF**. Please see Page 12 in the **MIDI and Sequencers** chapter the **MIDI Tutorial** section of this manual for more details.

MIDI Clock Source (Menu Page 7)

The K-Station requires a master timing clock in order to determine the tempo (rate) of the arpeggiator and to provide a time base for synchronization to other musical timings. This clock may be derived internally or received from an external device that is able to send a master timing clock (This is often known as a MIDI clock).

This setting determines whether the K-Station's tempo synchronised features (Arpeggiator, Chorus Sync, EQ Sync, Delay Sync & Panning Sync) will follow the tempo of an external sequencer (external clock) or follow the tempo set by the TEMPO knob found in the Arpeggiator section (external clock).

When set to **EXT**, external clock synchronisation is being used and the temp will be calculated from MIDI Clock messages received from a sequencer. Make sure the external sequencer is set to transmit MIDI Clock. Consult the sequencer manual for details.

Note : Most sequencers do not transmit MIDI Clock while they are stopped. Synchronization of the K-Station to MIDI Clock will only be possible while the sequencer is actually recording or playing.

When set to **INT**, the K-Station's own internal clock is used for synchronisation purposes. The tempo of the internal clock is controlled by the

Global Sync Mode	
NOTE 1	First Note when All Notes are Off
NOTE P	First Note after Program Change
SNG ST	Midi Song Start message

TEMPO knob found in the Arpeggiator section.

MIDI Clock Input Status (Menu Page 8)

Sometimes it is desirable to monitor whether a sequencer is actually transmitting MIDI Clock information. This is especially useful for troubleshooting if **MIDI Clock Source** is set to **EXT**.

To see if an external device is sending a MIDI clock, select this Menu Page. If an external clock is being received, the display will indicate the tempo of the external clock. If not -- will be displayed. If **ON** is displayed, synchronisation to the internal clock is being used.

Global Sync Mode (Menu Page 9)

If **MIDI Clock Source** is set to **EXT** (external clock), a clock synchronization type may be selected using this function. This allows the *first note played after all notes have been released* or *the first note played after a MIDI Program Change or MIDI Start Song Message* to synchronize the Panning, EQ Filter and Chorus LFO's and voice LFO's as described on page 26. This allows them to have their start position locked in time with the musical piece for stunning effects.

Velocity Curve (Menu Page 10)

The response to MIDI velocity information from an external device such as a MIDI controller keyboard or a sequencer may be set using this function.

A setting of **SOFT** indicates that smaller changes in velocity (a lighter playing style) will create a large change in response to velocity, be it

The Global Menu

volume or any other modulation destination that velocity is routed to.

A setting of **HARD** indicates that higher changes in velocity - a much harder playing style, will create large changes in response to velocity.

Function Display Time (Menu Page 11)

In Normal operation, whenever the K-Station is in Menu Mode or Program Mode, the display will show the current page within the currently selected menu. If a knob is moved on the K-Station's front panel, the display will momentarily switch to show the moved knob's value. After a while, the display reverts to showing the menu page previously displayed.

Use this function to adjust the amount of time these temporary messages are displayed on the screen before reverting back to the previous display. Short values give a very brief display period. Longer values increase the display time. A setting of **0** will inhibit the temporary messages being displayed altogether.

Prog Mode Display Control (Menu Page 12)

This function applies only when the K-Station is *not* in Menu Mode. It determines how the K-Station will behave when a front panel control is altered.

When set to **TIME**, the K-Station will automatically return back to Program Select Mode after a short period of time (determined by the Global **Function Display Time** setting as described above).

If set to **PERM**, when a front panel control is moved, the K-Station will remain in Program Edit Mode until another mode of operation is selected.

New Menu Always Page 1 (Menu Page 13)

All display menus (including this Global one) can operate in one of two different modes. The first mode (factory default setting) specifies that each time a new menu key is pressed, the *first Page in the menu list is always selected*. For example, pressing the keypad button '2' (selecting the Filter Menu) while in Menu Mode will result in always selecting the menu Page showing the Filter **Q Normalise** setting.

The second mode specifies that the *last accessed Page in the menu list is selected the next time that menu is accessed*. For example, if the Filter **Overdrive** setting is being adjusted (Filter menu Page 2), if a different menu is now selected (for example, the Oscillators Menu) and the Filter menu is subsequently selected again, the menu page showing the **Overdrive** setting would be displayed again.

Select **OFF** for the last accessed menu page to be remembered when a menu is selected and **ON** for a newly selected menu to always display the first page in its menu list.

Using the External Audio Input

In order to use an external audio input, the K-Station must be set up to correctly to respond to the level (amplitude) of the incoming signal. Since the levels of these signals can vary substantially, the Global menu functions **Input Sensitivity Range** and **Input Trim dB** (detailed below) must be adjusted for optimum performance. This will minimize signal distortion and noise.

Input Sensitivity Range (Menu Page 14)

Connect the input device to the rear panel jack labeled INPUT. When connecting devices such as CD players, Turntables, Mixing desks or other line level equipment, set the **Input Sensitivity Range** to **LINE**.



Input Sensitivity set to LINE

Set to **MIC** for low level devices such as Guitars or Microphones. Once set, play (or talk into the microphone) the input device.



The first five character blocks (forming a horizontal bar) to the left of the display will illuminate according to the level of the signal. It is likely that they will all illuminate, or just the lowest one or two to the left. The **Input Trim dB** function must now be used to optimize performance.

Input Trim dB (Menu Page 15)

After **Input Sensitivity Range** has been set, the sensitivity must be 'trimmed' for best performance. Whilst the input signal is present, adjust this value using the DATA knob until the the first four blocks are fully lit and the fifth block lights occasionally as shown in the illustration below.



The sensitivity level is now set correctly. In order to hear the external signal through the effects processor or to make the signal trigger sounds, the current PROGRAM selected has to have external audio enabled. This is done from within the Envelopes Menu (see the **Audio Input Triggering** and **External Audio To Effects** functions on Page 27).

Setting an External Audio Signal to Trigger the Envelopes

It is possible to make the K-Station trigger automatically (thus opening the Amplifier and Filter via the Envelopes) whenever an external signal is present. To do this, it is necessary to determine a *threshold* level, where the Envelopes are triggered whenever the signal reaches or passes a certain loudness point. The threshold is set by using the following **Input Trigger Sensitivity** function.

Input Trigger Sensitivity (Menu Page 16)

This function sets the audio input *threshold* level, in other words, how loud the external signal has to be in order to trigger the Envelopes. Low values require a very loud signal to auto-trigger. Higher values progressively enable much quieter signals to trigger the Envelopes.

Note that it is necessary for a Program to have its **Audio Input Triggering** setting (in the Envelopes Menu) switched to **ON** in order for auto-triggering to take place. See Page 27 for details on how to set this.

NOTE: If the external audio signal seems to be distorting when using a microphone or guitar (without the distortion effect turned on) try selecting **LINE** instead of **MIC** using the input sensitivity function.

Experiment with different settings until the external audio signal reliably triggers the K-Station as required.

Whenever the K-Station is auto-triggered in this way, it actually behaves as if a Middle C note has been played on the keyboard. It may well be necessary to use the Mixer controls to turn down the levels of the Oscillators if a pitched element to the sound is not required. This is especially recommended if it is desired to hear only the external audio signal passed through the Filter.

Octave Buttons - KILL - Control (Menu Page 17)

When Octave KILL is set to ON, as soon as either the OCTAVE UP or DOWN button is pressed all notes will be turned off. Set to OFF and notes will remain on even when the keyboard is being played in another Octave.

Hanging notes may be cancelled by switching back to the former octave and re-playing the same notes. As a safety when in this mode, all notes may also be turned off by pressing the PROGRAM button.

The Aftertouch & Breath Menu

This menu controls how the K-Station responds to Aftertouch and Breath Control (CC2) MIDI messages. It is selected by pressing the keypad '9' button when the K-Station is in **Menu Mode**. Use the PAGE up/down buttons to scroll through the Menu functions available - See table below.

Aftertouch / Breath Menu			
Page	Function	Display	Value
1	Atouch: Osc 1,2,3 Pitch Shift	AT Pitch	-64...63
2	Atouch: Osc 1,2,3 Pitch Mod (lfo1)	AT Pitch Mod	-64...63
3	Atouch: Filter Frequency Shift	AT Filt Freq	-64...63
4	Atouch: Filter Frequency Mod (lfo2)	AT FFreq Mod	-64...63
5	Atouch: Amp Gain (post-distortion)	AT Amp Gain	-64...63
6	Breath: Osc 1,2,3 Pitch Shift	BR Pitch	-64...63
7	Breath: Osc 1,2,3 Pitch Mod (lfo1)	BR Pitch Mod	-64...63
8	Breath: Filter Frequency Shift	BR Filt Freq	-64...63
9	Breath: Filter Frequency Mod (lfo2)	BR FFreq Mod	-64...63
10	Breath: Amp Gain (post-distortion)	BR Amp Gain	-64...63

Ensure that a connected MIDI device is configured to transmit Aftertouch or Breath Control MIDI data (if in doubt, consult the device's manual for details).

In order to hear the effect of any of these settings, press a key on the connected keyboard or blow into the breath controller while adjusting the values.

Note that the K-Station's own keyboard *does not* generate Aftertouch data. Aftertouch messages can only be sent from an external MIDI keyboard or sequencer.

Atouch : Osc 1, 2, 3 Pitch Shift (Menu Page 1)

This setting is used to shift the absolute pitch of the Oscillators up or down in response to incoming Aftertouch data.

Set in the range **-64** to **-1**, and any Aftertouch data will shift the pitch of the Oscillators downwards. With a range of **1** to **63**, any Aftertouch data received will shift the pitch of the Oscillators upwards. Greater values increase the amount of pitch shifting applied.

At a setting of **0**, Aftertouch messages will have no effect.

Atouch : Osc 1, 2, 3 Pitch Mod (LFO 1) (Menu Page 2)

Enables LFO 1 to modulate the pitch of the Oscillators, introducing a vibrato effect. As Aftertouch messages are received, the LFO 1 modulation will be applied. As the Aftertouch data falls back towards zero, the amount of LFO 1 modulation to the Oscillators pitch will also decrease.

Adjust this value to set the depth of pitch modulation applied by LFO 1. At a setting of **0**, Aftertouch messages will have no effect.

For best results, ensure that LFO 1 is using a Triangle waveform. This will give a smooth, traditional vibrato effect.

Atouch : Filter Frequency Shift (Menu Page 3)

This setting is used to shift the Cutoff FREQUENCY of the Filter up or down in response to incoming Aftertouch data.

Set in the range **-1** to **-64**, the Filter will close (the Cutoff FREQUENCY will decrease) as Aftertouch data is applied. With a range of **1** to **63**, the Filter will open (the Cutoff FREQUENCY will increase) as Aftertouch data is applied. Greater values will open (increase the Cutoff FREQUENCY) as Aftertouch data is received. At a setting of **0**, Aftertouch messages will have no effect.

Atouch : Filter Frequency Mod (LFO 2) (Menu Page 4)

Enables LFO 2 to modulate the Cutoff FREQUENCY of the Filter, introducing a 'wow-wow' effect. As Aftertouch messages are received, the LFO 2 modulation will be applied. As the Aftertouch data falls back towards zero, the amount of LFO 2 modulation to the Filter Cutoff FRE-

QUENCY will also decrease.

Adjust this to set the depth of modulation applied by LFO 2. At a setting of **0**, Aftertouch messages will have no effect.

For best results, ensure that LFO 2 is using a Triangle waveform. This will give a smooth, traditional 'wow-wow' effect.

Atouch : Amp Gain (post - distortion) (Menu Page 5)

Allows Aftertouch messages to directly alter the Amplifier level, allowing the overall volume of a sound to be altered.

Positive values of (**1** to **63**) increase the output volume of the Amp Envelope as Aftertouch is applied. Negative values (**-1** to **-64**) decrease the output volume of the Amp Envelope as Aftertouch is applied. At a setting of **0**, Aftertouch messages will have no effect.

Routing Breath Control

It is also possible to use incoming Breath Control MIDI messages to affect and modulate sounds. The principle of using Breath Control is exactly the same as the way in which Aftertouch is applied.

The remaining five pages in the menu offer exactly the same features and routings as are available for Aftertouch, but these settings apply to Breath Control information.

The Wheels Menu

This menu controls how the K-Station will respond to Pitch and Modulation from its own pitch and mod wheels. It is selected by pressing the keypad '8' button when the K-Station is in **Menu Mode**. Use the PAGE up/down buttons to scroll through the Menu functions available - See table below.

Wheels Menu			
Page	Function	Display	Value
1	Osc 1 Pitch Bend Semitones	BW Osc1 Bend	-12...12
2	Osc 2 Pitch Bend Semitones	BW Osc2 Bend	-12...12
3	Osc 3 Pitch Bend Semitones	BW Osc3 Bend	-12...12
4	Osc 1,2,3 Pitch Shift in Semitones	MW Pitch	-64...63
5	Osc 1,2,3 Pitch Mod (LFO1)	MW Pitch Mod	-64...63
6	Filter Frequency Shift	MW Filt Freq	-64...63
7	Filter Frequency Mod (LFO2)	MW FFreq Mod	-64...63
8	Amplifier Gain (post-distortion)	MW Amp Gain	-64...63

Oscillator 1,2 and 3 Pitch Bend Amount (Menu Page 1)

This setting is used to shift the absolute pitch of the Oscillators up or down in response to the Pitch (left hand) Wheel position. Values **1** to **12** will result in a higher pitch from 1 to 12 semitones when the wheel is pushed forward. Display values **-1** to **-12** will result in a lower pitch.

NOTE: If the current program uses more than one Oscillator, it is recommended that the bend amount is set equal for each Oscillator. If chord type effects are required when moving the pitch wheel, different pitch bend amounts may be set for each Oscillator.

Modulation Wheel Pitch shift in Semitones (Menu Page 4)

It may be desirable to drastically change the pitch of all the Oscillators using the Modulation Wheel. This setting is used to shift the absolute pitch of the all the Oscillators up or down in response to the Modulation (right hand) Wheel position. Values **1** to **63** will result in a higher pitch from **1** to **63** semitones when the wheel is pushed forward. Values **-1** to **-64** will result in a lower pitch.

Oscillator 1, 2 and 3 Pitch Modulation from LFO 1 (Menu Page 5)

Enables LFO 1 to modulate the pitch of the Oscillators, introducing a vibrato effect. As the Modulation Wheel is pushed forwards LFO 1 modulation will be applied. As the Modulation wheel is pulled back the amount of LFO 1 modulation to the Oscillators pitch will decrease.

Adjust this value to set the depth of pitch modulation applied by LFO 1.

For best results, ensure that LFO 1 is using a Triangle waveform. This will give a smooth, traditional vibrato effect.

The Wheels and Arpeggiator Menu

The Wheels Menu

Opening or Closing the Filter using the Modulation Wheel (Menu Page 6)

The filter Cut off frequency may be raised (opening the filter) or lowered (closing the filter) directly from the modulation wheel using this menu option.

Positive values from **1** to **63** will open the Filter when the wheel is pushed forward. A negative values from **-1** to **-64** will close the Filter when the wheel is pushed forward.

Filter Frequency Modulation from LFO 2 using the Modulation Wheel (Menu Page 7)

Enables LFO 2 to modulate the Cutoff FREQUENCY of the Filter,. The popular 'wow-wow' effect will be heard if LFO 2 waveform is set to Triangle.

A positive value **1** to **63** will open the filter in time with LFO 2 above the basic Cut off frequency. A negative value **-1** to **-64** will close the filter in time with LFO 2 below the basic Cut off frequency.

Using a high value and setting LFO 2 to different waveforms will introduce dramatic effects when moving the modulation wheel.

Control of Main Volume from the Modulation Wheel (Menu Page 8)

By routing the Modulation wheel to the amplifier, the overall volume of the sound may be controlled. Positive values of **1** to **63** increase the output volume of the Amp Envelope as the Modulation Wheel is pushed forwards. Negative values from **-1** to **-64** decrease the output volume of the Amp Envelope as the Modulation Wheel is pushed forwards. At a setting of **0**, the wheel will have no effect.

The Arpeggiator Menu

To complement the front panel controls in the Arpeggiator section, there are many other functions located in the Arpeggiator Menu. This is selected by pressing the keypad '**0**' button when the K-Station is in **Menu Mode**. Use the PAGE up/down buttons to scroll through the Menu functions available - See table below.

Page	Function	Display	Value
1	Pattern	ARP Pattern	UP...RND
2	Octave Range	ARP Octaves	1...4
3	Gate Time	ARP Gate Tim	0...127
4	Latch	ARP Latch	OFF-ON
5	Keysync	ARP Keysync	OFF-ON
6	Sync Type	ARP Sync	32T...1 bar
7	Arp Note Desitination	ARP Notes	INT- EXT- I + E

Pattern (Menu Page 1)

This determines the Arpeggio pattern played by the Arpeggiator. There are six types of pattern available :

Arp Pattern	
UP	Up
DN	Down
UD1	Up/Down
UD2	Up/Down - end repeat
ORD	Order Played
RND	Random

Up

The arpeggio starts at the lowest note played and sweeps up through the notes until it reaches the highest note. It then starts at the bottom again and repeats the sequence.

Down

The arpeggio starts at the highest note played and sweeps down through the notes until it reaches the lowest note. It then starts at the top again and repeats the sequence.

Up/Down

The arpeggio starts at the lowest note played and sweeps up through the notes until it reaches the highest note. It then sweeps back down. This is useful when playing three notes in songs with a 3/4 time signature.

Up/Down - end repeat

The arpeggio starts at the lowest note played, plays it twice, and sweeps up through the notes until it reaches the highest note. It then plays the top note again and sweeps back down.

Order Played

The arpeggio plays the notes in the order they were played on the keyboard. Once at the end of the notes played it repeats the sequence.

Random

Notes played will be arpeggiated in a random order.

Octave Range (Menu Page 2)

Sets how many octaves the Arpeggio pattern will sweep through. The sweep range is selectable from 1 to 4 octaves.

Gate Time (Menu Page 3)

Sets the gate time or duration of the notes being played by the Arpeggiator. Small values of gate time produce a Staccato effect. Large values produce a Legato effect. Anticlockwise and the gate time is very short, clockwise and the gate time is long.

Latch (Menu Page 4)

When activated, remembers notes played on the keyboard, even after the notes have been released.

Once all notes on the keyboard have been released, the next chord to be played on the keyboard will clear the existing latch memory and only the newly played chord will be arpeggiated.

Note : It is possible to control the Arpeggiator Latch On/Off from an external Computer/Sequencer/Keyboard. Transmit MID CC 64 (Sustain) with a value of 127 to turn the Arpeggiator latch **ON** and transmit controller number 64 with a value of 0 to turn the latch **OFF**.

Keysync (Menu Page 5)

When activated, the arpeggio pattern will re-start whenever a new note is played on the keyboard.

Sync Type (Menu Page 6)

Allows the Arpeggiator to be synchronized with an external sequencer. A range of synchronization values are available :

Arpeggiator Sync to MIDI Clock table		
Display	MIDI Clocks	Synchronised to
OFF	-	Manual Rate
32nd T	2	32nd Triplet
32nd	3	32nd
16th T	4	16th Triplet
16th	6	16th
8th T	8	8th Triplet
16th D	9	16th Dotted
8th	12	8th
4th T	16	4th Triplet
8th D	18	8th Dotted
4th	24	4th
2nd T	32	2nd Triplet
4th D	36	4th Dotted
2nd	48	2nd
1bar T	64	1 Bar Triplet
2nd D	72	2nd Dotted
1 bar	96	1 Bar

When a sync interval is selected, the tempo of the Arpeggiator is controlled by the Arpeggiator TEMPO knob when **MIDI Clock Source** is set to **INT**, or by the external sequencer's tempo when **MIDI Clock Source** is set to **EXT**. See Page 35 for information on setting the Global **MIDI Clock Source**.

The Arpeggiator Menu

Arp Destination (Menu Page 7)

For flexibility, the Arpeggiator output may be routed to a number of destinations. Setting the Arp destination to **INT** routes the Arpeggiated notes to the internal sound engine. This could be considered as the normal mode of operation.

Setting the destination to **EXT** will route the Arpeggiated notes ONLY to the MIDI output socket and they will be transmitted as MIDI note on/off information. The MIDI note information will be present on the **Keyboard Transmit** channel. (See page 35 GLOBAL Menu Page 4 to change this channel number).

Setting the destination to **I + E** (internal and external) will route Arpeggiated notes to both the MIDI output socket and the internal sound engine.

NOTE: When the option is set to either **EXT** or **I + E** and the MIDI transmit channel and the Keyboard transmit channel are the same, normal note on/off information will be suppressed on the MIDI transmit channel.

If the MIDI transmit channel and the Keyboard transmit channel are different, then Arpeggiated notes will be present on the Keyboard transmit channel and normal notes played will be present on the MIDI transmit channel.

Advanced Connection Diagram

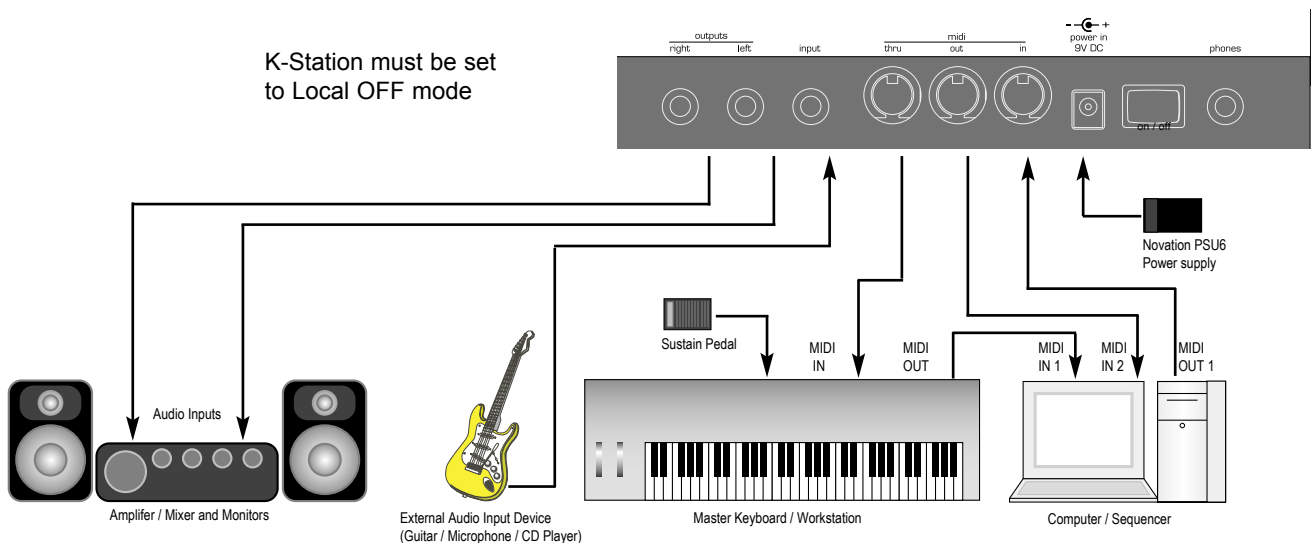

The diagram above illustrates how the K-Station is connected in a typical MIDI recording setup. It utilises all the Input and Output features. This setup allows real-time recording of knob movements into a Computer Software/Sequencer since both the MIDI output of the external keyboard and the MIDI output of the K-Station are connected to the Computer Software/Sequencer.

The Computer Software/Sequencer MUST have at least 2 MIDI inputs to allow knob movements to be recorded at the same time as playing the keyboard. If it does not, then a MIDI merge box must be used to merge the MIDI information from the keyboard and the K-Station into a single stream (Consult the manufacturers user guide for the MIDI merge box for correct connection). If the Master Keyboard is a Workstation (it has a Synthesizer built in) set it to *Local Off* or the equivalent in its MIDI setup.

Turn the Computer Software/Sequencers *Soft Thru* (or sometimes called *Echo Back*) to the *On* or *Enabled* position. Select a track in the Computer Software/Sequencer and assign it to the MIDI receive channel of the K-Station.

Play the keyboard and an audio output from the K-Station should be heard through the Headphones/Monitors. Tracks on the Computer Software/Sequencer that are assigned to the MIDI channel(s) of the workstation should also trigger sounds in the workstation.

Factory Preset Sounds Listing

Bank 1 - Sounds 100 - 199

No.	Name	No.	Name	No.	Name	No.	Name	No.	Name	No.	Name	No.	Name	No.	Name	No.	Name	No.	Name	No.	Name
100	Bass1	110	Bass2	120	Bass3	130	Bass4	140	Bass5	150	Bass6	160	Bass7	170	Bass8	180	Bass9	190	Bass10		
101	Hard Lead1	111	Hard Lead2	121	Hard Lead3	131	Hard Lead4	141	Hard Lead5	151	Hard Lead6	161	Hard Lead7	171	Hard Lead8	181	Hard Lead9	191	Hard Lead10		
102	Arpeggio1	112	Arpeggio2	122	Arpeggio3	132	Arpeggio4	142	Arpeggio5	152	Arpeggio6	162	Arpeggio7	172	Arpeggio8	182	Arpeggio9	192	Arpeggio10		
103	Dance1	113	Dance2	123	Dance3	133	Dance4	143	Dance5	153	Dance6	163	Dance7	173	Dance8	183	Dance9	193	Dance10		
104	Pad1	114	Pad2	124	Pad3	134	Pad4	144	Pad5	154	Pad6	164	Pad7	174	Pad8	184	Pad9	194	Pad10		
105	Keyboard1	115	Keyboard2	125	Keyboard3	135	Keyboard4	145	Keyboard5	155	Keyboard6	165	Keyboard7	175	Keyboard8	185	Keyboard9	195	Keyboard10		
106	Strings1	116	Strings2	126	Strings3	136	Strings4	146	Strings5	156	Strings6	166	Strings7	176	Strings8	186	Strings9	196	Strings10		
107	Brass1	117	Brass2	127	Brass3	137	Brass4	147	Brass5	157	Brass6	167	Brass7	177	Brass8	187	Brass9	197	Brass10		
108	Organ1	118	Organ2	128	Organ3	138	Organ4	148	Organ5	158	Organ6	168	Organ7	178	Organ8	188	Organ9	198	Organ10		
109	Soft Lead1	119	Soft Lead2	129	Soft Lead3	139	Soft Lead4	149	Soft Lead5	159	Soft Lead6	169	Soft Lead7	179	Soft Lead8	189	Soft Lead9	199	Soft Lead10		

Bank 2 - Sounds 200 - 299

No.	Name	No.	Name	No.	Name	No.	Name	No.	Name	No.	Name	No.	Name	No.	Name	No.	Name	No.	Name	No.	Name
200	Bass11	210	Bass12	220	Bass13	230	Bass14	240	Bass15	250	Bass16	260	Bass17	270	Bass18	280	Bass19	290	Bass20		
201	Hard Lead11	211	Hard Lead12	221	Hard Lead13	231	Hard Lead14	241	Hard Lead15	251	Hard Lead16	261	Hard Lead17	271	Hard Lead18	281	Hard Lead19	291	Hard Lead20		
202	Arpeggio11	212	Arpeggio12	222	Arpeggio13	232	Arpeggio14	242	Arpeggio15	252	Arpeggio16	262	Arpeggio17	272	Arpeggio18	282	Arpeggio19	292	Arpeggio20		
203	Dance11	213	Dance12	223	Dance13	233	Dance14	243	Dance15	253	Dance16	263	Dance17	273	Dance18	283	Dance19	293	Dance20		
204	Pad11	214	Pad12	224	Pad13	234	Pad14	244	Pad15	254	Pad16	264	Pad17	274	Pad18	284	Pad19	294	Pad20		
205	Keyboard11	215	Keyboard12	225	Keyboard13	235	Keyboard14	245	Keyboard15	255	Keyboard16	265	Keyboard17	275	Keyboard18	285	Keyboard19	295	Keyboard20		
206	Trance1	216	Trance2	226	Trance3	236	Trance4	246	Trance5	256	Trance6	266	Trance7	276	Trance8	286	Trance9	296	Trance10		
207	Brass11	217	Brass12	227	Brass13	237	Brass14	247	Brass15	257	Brass16	267	Brass17	277	Brass18	287	Brass19	297	Brass20		
208	Motion1	218	Motion2	228	Motion3	238	Motion4	248	Motion5	258	SFX1	268	SFX2	278	SFX3	288	SFX4	298	SFX5		
209	FM1	219	FM2	229	FM3	239	FM4	249	FM5	259	Vocoder1	269	Vocoder2	279	Vocoder3	289	Ex Aud Trig	299	Ex Aud to FX		

Example Initialisation Sounds

Sound 300 - Double Saw Example 1

The double effect works by making each oscillator produce two waves for each setting - sine, saw and tri. These are normally in phase and appear to be one waveform. The phase difference between each of the two waves for a single oscillator can be independently phase shifted by adjusting the pulse amount control. The phase can be moved from -180 to 180 degrees.

This can be automated by using an LFO to adjust the phase difference between the two waves.

When a triangle LFO 2 wave is selected, this will ramp the phase difference of the double waves up and down and the result is similar to a chorus effect. At moderate to high settings this sounds much like PWM of a square wave.

In this sound only oscillator 1 is used. It is set to a sawtooth wave. The PWM position is set centrally and the PWM position from LFO 2 is set to +30. LFO 2 speed is set to 65 with the waveform as a tri wave.

Try varying the speed of LFO 2 and the PWM position from LFO 2 amount for different effects.

Sound 301 - Double Saw Example 2

When a sawtooth wave for LFO 2 is selected and used to modulate the phase difference between the two waves AND the LFO 2 pulse amount is set to maximum, a complete change in phase occurs between the double waves from maximum to minimum (180 to -180 degrees) during the cycle of 1 period of the LFO. This then repeats immediately from 180 degrees again. This is equivalent to two waves with a constant detune.

In this example only Oscillator 1 is used again. It is set to a sawtooth wave. The PWM position is set centrally and the PWM position from LFO 2 is set to +63. The LFO speed is set to 50 with the LFO 2 waveform as a saw wave.

Try varying the LFO speed to adjust the amount of detune between the double oscillators. Note that settings for the LFO 2 pulse amount that are not maximum or minimum values will produce clicks in the sound because the phase difference will be interrupted.

Sound 302 - Oscillator Sync Example

Oscillator 1 can sync Oscillator 2 so that each time Oscillator 1 completes its cycle it resets the start cycle of Oscillator 2. When listening to only Oscillator 2 this has a very distinctive sound.

Here the Oscillator 2 level is 100% and Oscillator levels for Oscillators 1&3 are both 0%. Oscillator 1 has no envelope modulation whereas Oscillator 2 has a mod env depth of 45. The modulation envelope is set with an attack of 080 and a decay of 100. The sustain and release times for the mod envelope are 000. As the pitch of Oscillator 1 rises and falls this changes the way the Oscillator 2 wave is reset.

Try experimenting with the modulation envelope settings, the mod env depth amount for Oscillator 2 and the Octave / Semitone settings for Oscillators 1&2.

Sound 303 - Ring Mod Example

Here all the Oscillator levels are set to 000. The Ring Mod level is set to 100%. The modulation envelope has an attack setting of 035 and a decay setting of 105. The mod env amount is set to +50 for Oscillator 2 and -40 for Oscillator 1.

Try experimenting with the modulation envelope settings, the mod env depth amount for Oscillators 1&2 and the octave / semitone settings for Oscillators 1&2.

Sound 304 - Main Output EQ Filter Example.

The additional main output tempo sync'ed enveloped filter.

This is a powerful eq filter which is at the output stage of the signal path of the K-Station. This can boost frequencies as well as attenuate them - compared to the low pass filter which can only attenuate. Positive settings of the amount control will boost frequencies above the frequency point and attenuate frequencies below it. Negative settings of the eq amount will attenuate frequencies above the frequency point and boost frequencies below it.

The key point to this feature is the EQ Depth control. This will use a dedicated LFO to move the frequency point of the eq. The eq LFO can be sync'ed to midi clock or to the arpeggiator clock and an eq initial position can also be set just like for the chorus and pan effects.

This example has been set up for use with an external input. It will work particularly well with drum loops etc. Try varying the amp envelope controls and the eq level, depth, rate and frequency controls.

K-Station Technical Specification

Oscillators 1, 2 and 3

Waveform	Square / Saw / Variable Pulse / Tri / Sine / Double Saw / Double Tri / Double Sine
Octave Range	Shift -1 / 0 /+1 / +2
Mod Env Depth	-100% to +100%
LFO1 Depth	-100% to +100%
PWM Source	Mod Env / Manual / LFO2
Ring Mod	1 * 2
FM	2 * 3
2 * 3 FM Level	0 – 100%
2 * 3 FM Mod Level	0 – 100%
FM Env Attack Rate	500uS-20 Seconds
FM Env Decay Rate	1mS-20 Seconds

Comprehensive Aftertouch, Breath and Pitch / Mod Wheel control of both static pitch and modulation of pitch

Mixer

Osc 1 Level	0 – 100%
Osc 2 Level	0 – 100%
Osc 3 Level	0 – 100%
Noise Level	0 – 100%
FM Level	0 – 100%
External Input Level	0 – 100%

Filter

Frequency	5Hz-24kHz
Resonance	0-Self Oscillation (24dB mode)
Mod Env Depth	-100% to +100%
LFO 2 Depth	-100% to +100%
Cut Off	0-100%
Keyboard Tracking	0-100%
Overdrive / Q normalise	0-100%

Comprehensive Aftertouch, Breath and Pitch / Mod Wheel control of both static filter freq and modulation of filter freq

Amplifier Envelope

Velocity	-100% to +100%
Attack	250uS-20 Seconds
Decay	1mS-20 Seconds
Sustain	0-100%
Release	1mS – 20 Seconds

Mod Envelope

Velocity	-100% to +100%
Decay	1mS-20 Seconds
Sustain	0-100%
Release	1mS – 20 Seconds

LF01

Waveform	Sample & Hold / Tri / Saw / Squ
Speed	0 Hz – 1Khz
Delay Fade In	0 – 5 Seconds
LFO Sync	Internal – MIDI Clock

LF02

Waveform	Sample & Hold / Tri / Saw / Squ
Speed	0 Hz – 1Khz
Delay Fade In	0 – 5 Seconds
LFO Sync	Internal – MIDI Clock

Arpeggiator

Arpeggiator	Speed / Range / Gate Time / MIDI Clock / Sync / Keysync
-------------	--

Interfacing

MIDI Sockets	In / Out / Thru
Audio Input	Line Level 1 x Mono 1/4" Jack
Audio Outputs	Line Level 2 x Mono 1/4" Jack

Effects

Reverb	Level / Echo Chamber, Small Room Large Room, Small Hall, Large Hall Grand hall / Decay / Wheel Level
Chorus - Phaser	Level / Rate / Type / MIDI Clock Sync / Feedback / Mod Depth / Centre / MIDI clock sync initial Position Wheel Level
Distortion	Drive / Compensation / Wheel Level
Panning	Position / Mod Depth / Speed / MIDI clock Sync Initial Position
Delay	Depth / Time / Feedback / MIDI Clock Sync/ Stereo Width / Ratio / Wheel Level
Vocoder	On –Off / Sibalance Level / Sibalance Type
EQ / Filter	Depth / Freq / Mod Depth / Mod Speed MIDI clock sync / MIDI clock sync Initial position

General

Keyboard	2 Octave – 25 keys with velocity sensitivity - Pitch and Modulation Wheels
Power	9 Volt D.C. 600 mA
Dimensions	W=525mm H=94mm D= 295mm
Weight	4.0 Kg

MIDI Controller List

MIDI Controller List

Some controllers adhere to the normal midi-specified use (eg modwheel, volume) but most are used arbitrarily and no claim is made of compatibility with other Novation products or other manufacturer's products. This is a common practice among manufacturers.

Whilst an attempt has been made to avoid misuse of "standard" controllers which could cause problems, Novation takes no responsibility for compatibility issues.

Unless noted, controllers are transmitted and received. Unless noted, values have the range 0-127.

*** denotes a signed value where 64 represents zero.
Unless noted, this is -64..0..+63 stored as 0..64..127
another example is -12..0..+12 stored as 52..64..76

— denotes controller not used

Some controllers use the available 7 data value bits to control more than one parameter. These are noted as "packed parameters" and details are given.

The term "pulse width" is properly applied when squarewave is selected. For other waveforms, read "pulse width" as "double waveform phase offset". Double waveform phase offset is zero when the signed pulse width position parameter is 64 (meaning 0).

#	MIDI-SPECIFIED USE	K-STATION USE
0	bank msb	IGNORED/NOT TRANSMITTED
1	modwheel msb	MODWHEEL (receive only)
2	breath msb	BREATH CONTROL (receive only)
3	undefined msb	ARP PATTERN (0.5 = up, down, ud1, ud2, order, random)
4	foot controller msb —	
5	portamento time msb	PORTAMENTO TIME
6	data entry msb	USED FOR NRPN DATA VALUES
7	volume msb	VOLUME
8	balance msb	PREGLIDE SEMITONES *** -12..+12 (0=preglide disabled)
9	undefined msb	ARP RATE (64..191 bpm)
10	pan msb	PAN POSITION ***
11	expression msb	—
12	effect control 1 msb	NON-SYNC PAN RATE
13	effect control 2 msb	SYNC PAN RATE 0..34 (non-sync, 32Triplet..12bars)
14	undefined msb	VOCODER STEREO WIDTH
15	undefined msb	VOCODER SIBILANCE LEVEL
16	gen. controller 1 msb	MODWHEEL DISTORTION ***
17	gen. controller 2 msb	DISTORTION COMPENSATION
18	gen. controller 3 msb	MODWHEEL DELAY SEND
19	gen. controller 4 msb	NON-SYNC DELAY TIME
20	undefined msb	SYNC DELAY TIME 0..19 (non-sync, 32Triplet..2bars)
21	undefined msb	DELAY FEEDBACK
22	undefined msb	DELAY STEREO WIDTH
23	undefined msb	DELAY RATIO
24	undefined msb	MODWHEEL REVERB SEND ***
25	undefined msb	REVERB DECAY
26	undefined msb	MODWHEEL CHORUS SEND ***
27	undefined msb	NON-SYNC CHORUS RATE
28	undefined msb	SYNC CHORUS RATE 0..34 (non-sync, 32Triplet..12bars)
29	undefined msb	CHORUS FEEDBACK ***
30	undefined msb	CHORUS MOD DEPTH
31	undefined msb	CHORUS MOD CENTRE POINT
32	bank lsb	BANK SELECT 1..4
33	modwheel lsb	EQ LEVEL *** (0, 1..63, 64, 65..126, 127 = LP, LPshelf, flat, HPshelf, HP)
34	breath lsb	EQ FREQUENCY
35	undefined lsb	NON-SYNC EQ MOD RATE
36	foot controller lsb	SYNC EQ MOD RATE 0..34 (non-sync, 32Triplet..12bars)
37	portamento time lsb	EQ MOD DEPTH
38	data entry lsb	—
39	volume lsb	—
40	balance lsb	OSC1 SEMITONE *** -12..+12
41	undefined lsb	OSC1 CENT *** -50..+50
42	pan lsb	OSC1 BENDWHEEL PITCH AMOUNT ***
43	expression lsb	OSC1 LFO1 PITCH AMOUNT ***
44	effect control 1 lsb	OSC1 MOD.ENV PITCH AMOUNT ***
45	effect control 2 lsb	OSC1 PULSE WIDTH POSITION *** (0=50% or in-phase double wave)
46	undefined lsb	OSC1 LFO2 PULSE WIDTH MOD ***
47	undefined lsb	OSC1 MOD.ENV PULSE WIDTH MOD ***
48	gen. controller 1 lsb	OSC2 SEMITONE *** -12..+12
49	gen. controller 2 lsb	OSC2 CENT *** -50..+50
50	gen. controller 3 lsb	OSC2 BENDWHEEL PITCH AMOUNT ***
51	gen. controller 4 lsb	OSC2 LFO1 PITCH AMOUNT ***

#	MIDI-SPECIFIED USE	K-STATION USE
52	undefined lsb	OSC2 MOD.ENV PITCH AMOUNT ***
53	undefined lsb	OSC2 PULSE WIDTH POSITION *** (0=50% or in-phase double wave)
54	undefined lsb	OSC2 LFO2 PULSE WIDTH MOD ***
55	undefined lsb	OSC2 MOD.ENV PULSE WIDTH MOD ***
56	undefined lsb	OSC3 SEMITONE *** -12..+12
57	undefined lsb	OSC3 CENT *** -50..+50
58	undefined lsb	OSC3 BENDWHEEL PITCH AMOUNT ***
59	undefined lsb	OSC3 LFO1 PITCH AMOUNT ***
60	undefined lsb	OSC3 MOD.ENV PITCH AMOUNT ***
61	undefined lsb	OSC3 PULSE WIDTH POSITION *** (0=50% or in-phase double wave)
62	undefined lsb	OSC3 LFO2 PULSE WIDTH MOD ***
63	undefined lsb	OSC3 MOD.ENV PULSE WIDTH MOD ***
64	sustain pedal	SUSTAIN / MOMENTARY ARP LATCH ON
65	portamento on/off	ENVELOPE MODES / OSC WAVEFORM KEYSYNC (see packed parameter 1)
66	sostenuto pedal	—
67	soft pedal	UNISON / VOICE TYPE / FILTER TYPE (see packed parameter 2)
68	legato footswitch	UNISON DETUNE
69	hold 2	INDIVIDUAL OSCILLATOR RANDOM DETUNE
70	sound controller 1	OSC 1,2,3 WAVEFORM / PORTAMENTO MODE (see packed parameter 3)
71	sound controller 2	OSC 1,2,3 OCTAVE / OSC 1>2 SYNC (see packed parameter 4)
72	sound controller 3	OSC1 LEVEL (to filter)
73	sound controller 4	OSC2 LEVEL (to filter)
74	sound controller 5	OSC3 LEVEL (to filter)
75	sound controller 6	NOISE LEVEL (to filter)
76	sound controller 7	OSC 1*2 RINGMOD LEVEL (to filter)
77	sound controller 8	EXTERNAL INPUT (to filter)
78	sound controller 9	LFO 1,2 WAVEFORM / DELAY MULTI MODE (see packed parameter 5)
79	sound controller 10	LFO 1,2 KEYSYNC / LOCK / PHASE CONTROL (see packed parameter 6)
80	gen. controller 5 lsb	NON-SYNC LFO1 SPEED
81	gen. controller 6 lsb	SYNC LFO1 SPEED (0=NON-SYNC)
82	gen. controller 7 lsb	LFO1 DELAY (GRADUAL ONSET TIME)
83	gen. controller 8 lsb	NON-SYNC LFO2 SPEED
84	portamento control	SYNC LFO2 SPEED (0=NON-SYNC)
85	undefined	LFO2 DELAY (GRADUAL ONSET TIME)
86	undefined	— (may be used in future software releases)
87	undefined	ARPEGGIATOR SYNC SETTING 0..15 (32Triplet..1 bar)
88	undefined	ARPEGGIATOR GATE TIME (100+ GIVES TIED NOTE IN MONO MODE)
89	undefined	ARPEGGIATOR CONTROL (see packed parameter 7)
90	undefined	—
91	effects 1 depth	REVERB SEND LEVEL
92	effects 2 depth	DELAY SEND LEVEL
93	effects 3 depth	CHORUS SEND LEVEL
94	effects 4 depth	PAN MOD DEPTH
95	effects 5 depth	VOCODER BALANCE (0=off 64=full vocoder 127=modulator only)
96	data increment	—
97	data decrement	—
98	nrpn lsb	NRPN NUMBER
99	nrpn msb	IGNORED / NOT TRANSMITTED (for future compatibility, assume value is 0)
100	rpn lsb	—
101	rpn msb	—
102	undefined	FILTER FREQUENCY LFO2 MOD DEPTH ***
103	undefined	FILTER Q NORMALISE (127=zero filter drive at max resonance)
104	undefined	FILTER OVERDRIVE
105	undefined	FILTER FREQUENCY
106	undefined	FILTER RESONANCE
107	undefined	FILTER FREQUENCY MOD.ENV DEPTH ***
108	undefined	AMPLITUDE ENVELOPE ATTACK
109	undefined	AMPLITUDE ENVELOPE DECAY
110	undefined	AMPLITUDE ENVELOPE SUSTAIN
111	undefined	AMPLITUDE ENVELOPE RELEASE
112	undefined	AMPLITUDE ENVELOPE VELOCITY DEPTH ***
113	undefined	— (may be used in future software releases)
114	undefined	MOD. ENVELOPE ATTACK
115	undefined	MOD. ENVELOPE DECAY
116	undefined	MOD. ENVELOPE SUSTAIN
117	undefined	MOD. ENVELOPE RELEASE
118	undefined	MOD. ENVELOPE VELOCITY DEPTH ***
119	undefined	VOICE LEVEL TO OUTPUT & EFFECTS
120	all sounds off	ALL NOTES OFF WITH FAST RELEASE (receive only)
121	reset controllers	RESET CONTROLLERS (receive only)
122	local on/off	LOCAL ON/OFF
123	all notes off	ALL NOTES OFF (receive only)
124	omni off	ALL NOTES OFF (receive only)
125	omni on	ALL NOTES OFF (receive only)
126	mono mode setup	ALL NOTES OFF (receive only)
127	poly mode on	ALL NOTES OFF (receive only)

MIDI NRPN List

The K-Station uses a few NRPNs as detailed below. Since less than 128 of them are used, only one NRPN msb (bank) is needed. Therefore only the NRPN lsb is transmitted/received and the NRPN msb is ignored and is not transmitted. For future compatibility, assume that the NRPN msb is 0.

NRPN lsb	K-STATION USE
0	FM FIXED LEVEL
1	FM ENVELOPE DEPTH ***
2	FM ENVELOPE VELOCITY DEPTH ***
3	FM ENVELOPE ATTACK
4	FM ENVELOPE DECAY
5	OSCs 1,2,3 MODWHEEL DIRECT PITCH DEPTH ***
6	OSCs 1,2,3 AFTERTOUCH DIRECT PITCH DEPTH ***
7	OSCs 1,2,3 BREATH DIRECT PITCH DEPTH ***
8	OSCs 1,2,3 MODWHEEL LFO1 PITCH DEPTH ***
9	OSCs 1,2,3 AFTERTOUCH LFO1 PITCH DEPTH ***
10	OSCs 1,2,3 BREATH LFO1 PITCH DEPTH ***
11	FILTER KEYBOARD TRACKING (0=NONE, 127=PRECISE PITCH TRACK)
12	FILTER MODWHEEL DIRECT FREQUENCY DEPTH ***
13	FILTER AFTERTOUCH DIRECT FREQUENCY DEPTH ***
14	FILTER BREATH DIRECT FREQUENCY DEPTH ***
15	FILTER MODWHEEL LFO2 FREQUENCY DEPTH ***
16	FILTER AFTERTOUCH LFO2 FREQUENCY DEPTH ***
17	FILTER BREATH LFO2 FREQUENCY DEPTH ***
18	AMPLITUDE MODWHEEL DIRECT DEPTH ***
19	AMPLITUDE AFTERTOUCH DIRECT DEPTH ***
20	AMPLITUDE BREATH DIRECT DEPTH ***
21	EFFECTS TYPE CONTROL (see packed parameter 8)
22	EFFECTS GLOBAL SYNC CONTROL (see packed parameter 9)
23	EFFECTS, VOCODER & EXTERNAL AUDIO CONTROL (see packed parameter 10)
24	RESERVED
25	EFFECTS SELECT/ KEYBOARD OCTAVE (see packed parameter 11)
26	OSC SELECT, NOISE RING EXTERNAL SELECT PWM SOURCE SELECT LFO SELECT ((see packed parameter 12)
27-31	— (may be used in future software releases)

NRPNs FOR GLOBAL DATA (not part of programs)

32	MIDI RECEIVE CHANNEL 0..15
33	MIDI TRANSMIT CHANNEL 0..15
34-37	— (may be used in future software releases)
38	MIDI CLOCK SOURCE (0=internal 1=external)
39	— (may be used in future software releases)
40	MASTER TUNE CENTS ***
41	VELOCITY CURVE (0=soft 1=hard)
42	EXTERNAL INPUT RANGE (0=line 1=mic)
43	EXTERNAL INPUT TRIM (-10..+20 dB)
44	EXTERNAL INPUT TRIGGER SENSITIVITY (0 is most sensitive)
45	GLOBAL SYNC TYPE (0,1,2 = note when all notes off, first note after prog change, midi song start)
46	PARAMETER MOMENTARY DISPLAY TIME (off.200..1200ms)
47	MENU INITIAL PAGE MODE (0=first 1=last used)
48	KEYBOARD TRANSMIT CHANNEL
49	NON MEMU MODE DISPLAY TIMEOUT NONE / PERMANENT 0=TIME 1=PERMANENT
50 -127	— (may be used in future software releases)

Packed Controller / NRPN Details

Refer to the lists of MIDI Controllers and NRPNs on Pages 42 - 44.

- 1 ENVELOPES SINGLE-MULTI / OSC WAVEFORM KEYSYNC**
 bit 0 amp env trigger 0=single 1=multi
 bit 1 mod env trigger 0=single 1=multi
 bit 2 fm env trigger 0=single 1=multi
 bits 3-6 4-bit wave keysync phase
 0=free-running 1..15 = 0..336 degrees in 24 degree steps
- 2 UNISON / POLY MODE / FILTER TYPE**
 bits 0-2 3-bit unison count
 0=off 1..7=2..8 voices
 bits 3-4 2-bit voice polyphony mode
 0=mono 1=mono autoglide 2=poly 3=poly with "same note voice stealing"
 bit 5 filter type 0=12dB 1=24dB per octave
- 3 OSC 1/2/3 WAVEFORM / PORTAMENTO MODE**
 bits 0-1 2-bit osc1 waveform sine, tri, saw, square (pulse)
 bits 2-3 2-bit osc2 waveform sine, tri, saw, square (pulse)
 bits 4-5 2-bit osc3 waveform sine, tri, saw, square (pulse)
 bit 6 portamento mode 0=exponential 1=linear
- 4 OSC 1,2,3 OCTAVE / OSC 1>2 SYNC**
 bits 0-1 2-bit osc1 octave -1,0,1,2
 bits 2-3 2-bit osc2 octave -1,0,1,2
 bits 4-5 2-bit osc3 octave -1,0,1,2
 bit 6 osc1>2 sync 1=on
- 5 LFO 1,2 WAVEFORM / DELAY MULTI MODE**
 bit 0 lfo1 delay multi 1=on
 bit 1 lfo2 delay multi 1=on
 bits 2-3 2-bit lfo1 waveform tri, saw, square, s/h
 bits 4-5 2-bit lfo2 waveform tri, saw, square, s/h
- 6 LFO 1,2 KEYSYNC / LOCK / PHASE CONTROL**
 bit 0 lfo1 keysync phase shift
 bit 1 lfo1 keysync 1=on
 bit 2 lfo1 lock 0=independent per voice 1=all voices same phase
 bit 3 lfo2 keysync phase shift
 bit 4 lfo2 keysync 1=on
 bit 5 lfo2 lock 0=independent per voice 1=all voices same phase
 note that when lock is on, keysync becomes global sync
 (ie note when all notes off, first note after prog change, song start message)
- 7 ARPEGGIATOR CONTROL**
 bits 0-1 2-bit number of octaves 1,2,3,4
 bit 2 arpeggiator off/on 1=on
 bit 3 arpeggiator keysync control 1=on
 bit 4 arpeggiator latch control 1=on
- 8 EFFECTS TYPE CONTROL**
 bits 0-2 3-bit reverb type Ec Sr Sh Lr Lh gh (values 6,7 not used)
 bit 3 chorus/phaser control 0=chorus 1=phaser
- 9 EFFECTS GLOBAL SYNC CONTROL**
 bits 0-1 2-bit chorus global sync off,left,centre,right
 bits 2-3 2-bit pan global sync off,left,centre,right
 bits 4-5 2-bit eq frequency global sync off,low,mid,high
- 10 EFFECTS, VOCODER & EXTERNAL AUDIO CONTROL**
 bit 3 vocoder sibilance type 0=hi-pass 1=noise
 bit 5 external audio trigger control 1=enabled
 bit 6 external audio to fx control 1=enabled
- 11 EFFECTS SELECT/ KEYBOARD OCTAVE**
 bits 0-2 0=Delay 1=reverb 2=chorus 3=distortion 4=EQ 5=panning 6=vocoder
 bit 3,4,5,6 Signed value 0 = Nominal Octave where middle C is 261Hz -4 = Lowest Octave +5 = Highest octave
- 12 OSC SELECT, NOISE RING EXTERNAL SELECT PWM SOURCE SELECT LFO SELECT**
 bits 0-1 Osc Select 0=1 1=2 2=3
 bits 2-3 0=Noise 1=Ring1,2 2=External Input
 bits 4-5 0=PW Position 1=LFO2 Mod 2=Mod Env Modbits 4-5
 bit 6 LFO Select 0= LFO1 1=LFO2

MIDI System Exclusive Message Formats

SYSEX MESSAGE COMMON FORMAT

F0h	SYSEX START	
00h	NOVATION ID 1	
20h	NOVATION ID 2	
29h	NOVATION ID 3	
01h	DEVICE TYPE	(1 = Synth)
41h	K-STATION	
SyCh	SYSEX CHANNEL	(Always transmitted as 7Fh for receive can be 7Fh or the receive channel)
M	MESSAGE TYPE	(Current Sound, Program, Global data etc. See following Messages)
C	CONTROL BYTE	(Used to control destination bank when program dumps are received)
Vv	SOFTWARE VERSION	(Bits:- 0VVVV.vvv eg 00001000 = version 1.0)
Vi	VERSION INCREMENT 0..99	(Hold keypad "5" during power-up to view the full version eg 1.0.06)
B	PROGRAM BANK 1..4	(Zero if not appropriate)
P	PROGRAM NUMBER 0..99	(Zero if not appropriate)
	DATA BLOCK	(data block(s))
	.	(included if)
	.	(appropriate to)
	DATA BLOCK	(message type)
F7h	END OF EXCLUSIVE	

Note: Currently, the software version and version increment bytes are transmitted for information only and are ignored when a message is received. Future software releases may, on receipt of some message types from an earlier version, alter the data before storing it. This will only apply to messages which contain data blocks. To ensure future compatibility, librarian programs should always maintain a match between the Vv and Vi byte values and the data block content.

SYSEX DATA DUMP MESSAGES

CURRENT SOUND DUMP

When received, this will be the active sound. It is not stored in flash.
The source bank and program number are irrelevant and the control byte is ignored.

F0h	SYSEX START	
00h	NOVATION ID 1	
20h	NOVATION ID 2	
29h	NOVATION ID 3	
01h	DEVICE TYPE	
41h	K-STATION	
SyCh	SYSEX CHANNEL	Transmitted 7Fh : Received 7Fh or current receive channel
00h	MESSAGE TYPE	Current sound dump
00h	CONTROL BYTE	Transmitted 0 : Received don't care
Vv	SOFTWARE VERSION	
Vi	VERSION INCREMENT	
00h	PROGRAM BANK	Transmitted 0 : Received don't care
00h	PROGRAM NUMBER	Transmitted 0 : Received don't care
	PROGRAM BLOCK 128 bytes	See PROGRAM DATA BLOCK On page A-10 for format
F7h	END OF EXCLUSIVE	

PROGRAM DUMP

When received, the sound is stored in flash at the supplied bank and program number if C = 1.
If C = 0, the bank used is the currently selected bank.

F0h	SYSEX START	
00h	NOVATION ID 1	
20h	NOVATION ID 2	
29h	NOVATION ID 3	
01h	DEVICE TYPE	
41h	K-STATION	
SyCh	SYSEX CHANNEL	Transmitted 7Fh : received 7Fh or current receive channel
01h	MESSAGE TYPE	Program dump
C	CONTROL BYTE	0 or 1 destination bank control
Vv	SOFTWARE VERSION	
Vi	VERSION INCREMENT	
B	PROGRAM BANK	Transmitted 1-4 : received don't care if C=0
P	PROGRAM NUMBER	0-99
	PROGRAM BLOCK 128 bytes.	See PROGRAM DATA BLOCK On page A-10 for format
F7h	END OF EXCLUSIVE	

MIDI System Exclusive Message Formats

PROGRAM PAIR DUMP

Conveys two adjacent programs where the first is even-numbered eg 98+99. Note that P must be even. When received, the two sounds are stored in flash at the supplied bank and program number if C = 1. If C = 0, the bank used is the currently selected bank.

F0h	SYSEX START	
00h	NOVATION ID 1	
20h	NOVATION ID 2	
29h	NOVATION ID 3	
01h	DEVICE TYPE	
41h	K-STATION	
SyCh	SYSEX CHANNEL	Transmitted 7Fh : Received 7Fh or current receive channel
02h	MESSAGE TYPE	Program pair dump
C	CONTROL BYTE	0 or 1 destination bank control
Vv	SOFTWARE VERSION	
Vi	VERSION INCREMENT	
B	PROGRAM BANK	Transmitted 1-4 : received don't care if C=0
P	PROGRAM NUMBER	0,2,4....98
	PROGRAM BLOCK 128 bytes.	Even numbered program - See PROGRAM DATA BLOCK On page A-10 for format
	PROGRAM BLOCK 128 bytes.	Odd numbered program - See PROGRAM DATA BLOCK On page A-10 for format
F7h	END OF EXCLUSIVE	

Note: the purpose of the program pair dump is for internal efficiency in flash memory storage. This message type is used for all bank dumps invoked from the front panel. A full bank dump consists of 50 program pair dumps.

When a single bank dump is transmitted, C=0 such that the receiving K-Station current bank will be the destination.

When an all banks dump is transmitted, C=1 such that the receiving Station will store the programs in the bank given in the B byte.

When a third party librarian or device receives either a program dump or program pair dump, it can ignore the C value but when it transmits one of these dumps to a K-Station, it must be aware of the effect of the C value.

GLOBAL DATA DUMP

When received, the flash global data block is overwritten.

The source bank and program number are irrelevant and the control byte is ignored.

F0h	SYSEX START	
00h	NOVATION ID 1	
20h	NOVATION ID 2	
29h	NOVATION ID 3	
01h	DEVICE TYPE	
41h	K-STATION	
SyCh	SYSEX CHANNEL	Transmitted 7Fh : received 7Fh or current receive channel
03h	MESSAGE TYPE	Global data dump
00h	CONTROL BYTE	Transmitted 0 : received don't care
Vv	SOFTWARE VERSION	
Vi	VERSION INCREMENT	
00h	(PROGRAM BANK)	Transmitted 0 : Received don't care
00h	(PROGRAM NUMBER)	Transmitted 0 : Received don't care
	GLOBAL DATA BLOCK 256 bytes.	See GLOBAL DATA BLOCK On page A-10 for format
F7h	END OF EXCLUSIVE	

SYSEX REQUEST MESSAGES (receive only)

CURRENT SOUND DUMP REQUEST

F0h	SYSEX START	
00h	NOVATION ID 1	
20h	NOVATION ID 2	
29h	NOVATION ID 3	
01h	DEVICE TYPE	
41h	K-STATION	
SyCh	SYSEX CHANNEL	7Fh or current receive channel
40h	MESSAGE TYPE	Current sound dump request
00h	CONTROL BYTE	Don't care
Vv	SOFTWARE VERSION	Ddon't care
Vi	VERSION INCREMENT	Ddon't care
00h	PROGRAM BANK	Don't care
00h	PROGRAM NUMBER	Don't care
F7h	END OF EXCLUSIVE	

MIDI System Exclusive Message Formats - Receive Requests

SYSEX REQUEST MESSAGES (receive only)

PROGRAM DUMP REQUEST

F0h	SYSEX START	
00h	NOVATION ID 1	
20h	NOVATION ID 2	
29h	NOVATION ID 3	
01h	DEVICE TYPE	
41h	K-STATION	
SyCh	SYSEX CHANNEL	7Fh or current receive channel
41h	MESSAGE TYPE	Program dump request
C	CONTROL BYTE	Reply will copy this value for C
Vv	SOFTWARE VERSION	Don't care
Vi	VERSION INCREMENT	Don't care
B	PROGRAM BANK	1-4 : don't care if C=0
P	PROGRAM NUMBER	0-99
F7h	END OF EXCLUSIVE	

PROGRAM PAIR DUMP REQUEST

F0h	SYSEX START	
00h	NOVATION ID 1	
20h	NOVATION ID 2	
29h	NOVATION ID 3	
01h	DEVICE TYPE	
41h	K-STATION	
SyCh	SYSEX CHANNEL	7Fh or current receive channel
42h	MESSAGE TYPE	Program pair dump request
C	CONTROL BYTE	Reply will copy this value for C
Vv	SOFTWARE VERSION	Don't care
Vi	VERSION INCREMENT	Don't care
B	PROGRAM BANK	1-4 : Don't care if C=0
P	PROGRAM NUMBER	0,2,4....98
F7h	END OF EXCLUSIVE	

GLOBAL DATA DUMP REQUEST

F0h	SYSEX START	
00h	NOVATION ID 1	
20h	NOVATION ID 2	
29h	NOVATION ID 3	
01h	DEVICE TYPE	
41h	K-STATION	
SyCh	SYSEX CHANNEL	7Fh or current receive channel
43h	MESSAGE TYPE	Global data dump request
00h	CONTROL BYTE	Don't care
Vv	SOFTWARE VERSION	Don't care
Vi	VERSION INCREMENT	Don't care
00h	(PROGRAM BANK)	Don't care
00h	(PROGRAM NUMBER)	Don't care
F7h	END OF EXCLUSIVE	

MIDI System Exclusive Message Formats

GLOBAL DATA BLOCK (256 bytes)

Byte	Parameter
0	POWER-UP PROGRAM BANK 1..4
1	POWER-UP PROGRAM NUMBER 0..99
2	MEMORY PROTECT (0=protected 1=not protected)
3	MIDI LOCAL CONTROL (0=off 127=on)
4	MIDI RECEIVE CHANNEL 0..15
5	MIDI TRANSMIT CHANNEL 0..15
6-9	--- (may be used in future software releases)
10	MIDI CLOCK SOURCE (0=internal 1=external)
11	--- (may be used in future software releases)
12	MASTER TUNE CENTS ***
13	VELOCITY CURVE (0=soft 1=hard)
14	EXTERNAL INPUT RANGE (0=line 1=mic)
15	EXTERNAL INPUT TRIM (-10..+20 dB)
16	EXTERNAL INPUT TRIGGER SENSITIVITY (0 is most sensitive)
17	GLOBAL SYNC TYPE (0,1,2 = note when all notes off, first note after prog change, midi song start)
18	PARAMETER MOMENTARY DISPLAY TIME (off.200..1200mS)
19	MENU INITIAL PAGE MODE (0=first 1=last used)
20	KEYBOARD/WHEELS MIDI TRANSMIT CHANNEL 0..15
21	PROGRAM MODE PARAMETER DISPLAY MODE (0=timed 1=permanent)
22	KEYBOARD OCTAVE SHIFT ALL-NOTES-OFF CONTROL (0=off 1=kill notes & send midi all-notes-off)
23-255	--- (may be used in future software releases) Zeros are transmitted. Use zeros for future compatibility

DATA BLOCKS USED IN SYSEX MESSAGES

See Midi Controller Map for further details of parameters and meaning of ***.

PROGRAM DATA BLOCK (128 bytes)

Byte	Parameter
0	UNISON / VOICE TYPE / FILTER TYPE (see packed parameter 2)
1	UNISON DETUNE
2	INDIVIDUAL OSCILLATOR RANDOM DETUNE
3	PORTAMENTO TIME
4	PREGLIDE SEMITONES *** -12..+12 (0=preglide disabled)
5	OSC 1,2,3 WAVEFORM / PORTAMENTO MODE (see packed parameter 3)
6	OSC 1,2,3 OCTAVE / OSC 1>2 SYNC (see packed parameter 4)
7	OSC1 SEMITONE *** -12..+12
8	OSC1 CENT *** -50..+50
9	OSC1 BENDWHEEL PITCH AMOUNT ***
10	OSC1 LFO1 PITCH AMOUNT ***
11	OSC1 MOD.ENV PITCH AMOUNT ***
12	OSC1 PULSE WIDTH POSITION *** (0=50% or in-phase double wave)
13	OSC1 LFO2 PULSE WIDTH MOD ***
14	OSC1 MOD.ENV PULSE WIDTH MOD ***
15	OSC2 SEMITONE *** -12..+12
16	OSC2 CENT *** -50..+50
17	OSC2 BENDWHEEL PITCH AMOUNT ***
18	OSC2 LFO1 PITCH AMOUNT ***
19	OSC2 MOD.ENV PITCH AMOUNT ***
20	OSC2 PULSE WIDTH POSITION *** (0=50% or in-phase double wave)
21	OSC2 LFO2 PULSE WIDTH MOD ***
22	OSC2 MOD.ENV PULSE WIDTH MOD ***
23	OSC3 SEMITONE *** -12..+12
24	OSC3 CENT *** -50..+50
25	OSC3 BENDWHEEL PITCH AMOUNT ***
26	OSC3 LFO1 PITCH AMOUNT ***
27	OSC3 MOD.ENV PITCH AMOUNT ***
28	OSC3 PULSE WIDTH POSITION *** (0=50% or in-phase double wave)
29	OSC3 LFO2 PULSE WIDTH MOD ***
30	OSC3 MOD.ENV PULSE WIDTH MOD ***
31	OSCs 1,2,3 MODWHEEL DIRECT PITCH DEPTH ***
32	OSCs 1,2,3 AFTERTOUCH DIRECT PITCH DEPTH ***
33	OSCs 1,2,3 BREATH DIRECT PITCH DEPTH ***
34	OSCs 1,2,3 MODWHEEL LFO1 PITCH DEPTH ***
35	OSCs 1,2,3 AFTERTOUCH LFO1 PITCH DEPTH ***
36	OSCs 1,2,3 BREATH LFO1 PITCH DEPTH ***

MIDI System Exclusive Message Formats

PROGRAM DATA BLOCK (continued)

37 OSC1 LEVEL (to filter)
38 OSC2 LEVEL (to filter)
39 OSC3 LEVEL (to filter)
40 NOISE LEVEL (to filter)
41 OSC 1*2 RINGMOD LEVEL (to filter)
42 EXTERNAL INPUT (to filter)

43 FILTER OVERDRIVE
44 FILTER RESONANCE
45 FILTER Q NORMALISE (127=zero filter drive at max resonance)
46 FILTER FREQUENCY
47 FILTER KEYBOARD TRACKING (0=NONE, 127=PRECISE PITCH TRACK)
48 FILTER MODWHEEL DIRECT FREQUENCY DEPTH ***
49 FILTER AFTERTOUCH DIRECT FREQUENCY DEPTH ***
50 FILTER BREATH DIRECT FREQUENCY DEPTH ***
51 FILTER FREQUENCY LFO2 MOD DEPTH ***
52 FILTER FREQUENCY MOD.ENV DEPTH ***
53 FILTER MODWHEEL LFO2 FREQUENCY DEPTH ***
54 FILTER AFTERTOUCH LFO2 FREQUENCY DEPTH ***
55 FILTER BREATH LFO2 FREQUENCY DEPTH ***

56 FM FIXED LEVEL
57 FM ENVELOPE DEPTH ***
58 FM ENVELOPE VELOCITY DEPTH ***
59 FM ENVELOPE ATTACK
60 FM ENVELOPE DECAY

61 AMPLITUDE ENVELOPE VELOCITY DEPTH ***
62 AMPLITUDE ENVELOPE ATTACK
63 AMPLITUDE ENVELOPE DECAY
64 AMPLITUDE ENVELOPE SUSTAIN
65 AMPLITUDE ENVELOPE RELEASE

66 MOD. ENVELOPE VELOCITY DEPTH ***
67 MOD. ENVELOPE ATTACK
68 MOD. ENVELOPE DECAY
69 MOD. ENVELOPE SUSTAIN
70 MOD. ENVELOPE RELEASE
71 --- (may be used in future software releases)

72 NON-SYNC LFO1 SPEED
73 SYNC LFO1 SPEED (0=NON-SYNC)
74 LFO1 DELAY (GRADUAL ONSET TIME)

75 NON-SYNC LFO2 SPEED
76 SYNC LFO2 SPEED (0=NON-SYNC)
77 LFO2 DELAY (GRADUAL ONSET TIME)

78 LFO 1,2 WAVEFORM / DELAY MULTI MODE (see packed parameter 5)
79 LFO 1,2 KEYSYNC / LOCK / PHASE CONTROL (see packed parameter 6)

80 ENVELOPE MODES / OSC WAVEFORM KEYSYNC (see packed parameter 1)

81 AMPLITUDE MODWHEEL DIRECT DEPTH ***
82 AMPLITUDE AFTERTOUCH DIRECT DEPTH ***
83 AMPLITUDE BREATH DIRECT DEPTH ***

84 ARPEGGIATOR/GENERAL SYNC RATE (64..191 bpm)
85 ARPEGGIATOR SYNC SETTING 0..15 (32Triplet..1 bar)
86 ARPEGGIATOR GATE TIME (100+ GIVES TIED NOTE IN MONO MODE)
87 ARP PATTERN (0..5 = up, down, ud1, ud2, order, random)
88 ARPEGGIATOR CONTROL (see packed parameter 7)

89 VOCODER BALANCE (0=off 64=full vocoder 127=modulator only)
90 VOCODER STEREO WIDTH
91 VOCODER SIBILANCE LEVEL

MIDI System Exclusive Message Formats

PROGRAM DATA BLOCK (continued)

92	EQ LEVEL *** (0, 1..63, 64, 65..126, 127 = LP, LP shelf, flat, HP shelf, HP)
93	EQ FREQUENCY
94	NON-SYNC EQ MOD RATE
95	SYNC EQ MOD RATE 0..34 (non-sync, 32Triplet..12bars)
96	EQ MOD DEPTH
97	DISTORTION LEVEL
98	MODWHEEL DISTORTION ***
99	DISTORTION COMPENSATION
100	DELAY SEND LEVEL
101	MODWHEEL DELAY SEND
102	NON-SYNC DELAY TIME
103	SYNC DELAY TIME 0..19 (non-sync, 32Triplet..2bars)
104	DELAY FEEDBACK
105	DELAY STEREO WIDTH
106	DELAY RATIO
107	REVERB SEND LEVEL
108	MODWHEEL REVERB SEND ***
109	REVERB DECAY
110	CHORUS SEND LEVEL
111	MODWHEEL CHORUS SEND ***
112	NON-SYNC CHORUS RATE
113	SYNC CHORUS RATE 0..34 (non-sync, 32Triplet..12bars)
114	CHORUS FEEDBACK ***
115	CHORUS MOD DEPTH
116	CHORUS MOD CENTRE POINT
117	PAN POSITION ***
118	NON-SYNC PAN RATE
119	SYNC PAN RATE 0..34 (non-sync, 32Triplet..12bars)
120	PAN MOD DEPTH
121	EFFECTS TYPE CONTROL (see packed parameter 8)
122	EFFECTS GLOBAL SYNC CONTROL (see packed parameter 9)
123	EFFECTS, VOCODER & EXTERNAL AUDIO CONTROL (see packed parameter 10)
124	--- (may be used in future software releases)
125	VOICE LEVEL TO OUTPUT & EFFECTS
126	EFFECT TYPE SELECTOR/KEYBOARD OCTAVE (see packed parameter 11)
127	OSC, SOURCE, PW, LFO SELECTORS (see packed parameter 12)

GLOBAL DATA BLOCK (256 bytes)

Byte	Parameter
0	POWER-UP PROGRAM BANK 1..4
1	POWER-UP PROGRAM NUMBER 0..99
2	MEMORY PROTECT (0=protected 1=not protected)
3	MIDI LOCAL CONTROL (0=off 127=on)
4	MIDI RECEIVE CHANNEL 0..15
5	MIDI TRANSMIT CHANNEL 0..15
6-9	--- (may be used in future software releases)
10	MIDI CLOCK SOURCE (0=internal 1=external)
11	--- (may be used in future software releases)
12	MASTER TUNE CENTS ***
13	VELOCITY CURVE (0=soft 1=hard)
14	EXTERNAL INPUT RANGE (0=line 1=mic)
15	EXTERNAL INPUT TRIM (-10..+20 dB)
16	EXTERNAL INPUT TRIGGER SENSITIVITY (0 is most sensitive)
17	GLOBAL SYNC TYPE (0,1,2 = note when all notes off, first note after prog change, midi song start)
18	PARAMETER MOMENTARY DISPLAY TIME (off.200..1200mS)
19	MENU INITIAL PAGE MODE (0=first 1=last used)
20	KEYBOARD/WHEELS MIDI TRANSMIT CHANNEL 0..15
21	PROGRAM MODE PARAMETER DISPLAY MODE (0=timed 1=permanent)
22	KEYBOARD OCTAVE SHIFT ALL-NOTES-OFF CONTROL (0=off 1=kill notes & send midi all-notes-off)
23-255	...may be used in future software releases Zeros are transmitted. Use zeros for future compatibility

MIDI Implementation Chart

MIDI Implementation Chart

Date 24/1/02
Version 1.0

Model : Novation K-Station

Function		Transmitted	Recognised	Remarks
Basic Channel	Default	1 - 16	1 - 16	Memorised
	Changed	1 - 16	1 - 16	
Mode	Default Messages Altered	X *****	MODE 3 - 4 X	Memorised in Program Data
Note Number	True Voice	0 - 127 *****	0 - 127	
Velocity	Note On Note Off	O v = 1 - 127 X	O v = 1 - 127 X	
Aftertouch	Keys Channel	X X	X O	
Pitch Bend		O	O	8 Bit data
Control Change		1, 3, 5 - 10 12 - 37, 40 - 65 67 - 85, 87 - 89 91 - 95, 98, 100 102 - 112, 114 - 119	1 - 3, 5 - 10 12 - 37, 40 - 65 67 - 85, 87 - 89 91 - 95, 98, 100 102 - 112, 114 - 127	See Controller & NRPN tables for full details
Program Change	True	0 - 99 *****	0 - 99	
System Exclusive		O	O	Program & Global data dumps, OS upgrades
System Real-Time		X	O	Start Song, Clock
System Common		X	X	
Aux Messages	Local On All Notes Off Active Sense Reset Control All Sound Off	O O X X X	O O X O O	

Mode 1 : OMNI ON, POLY Mode 2 : OMNI ON, MONO
Mode 3 : OMNI OFF, POLY Mode 4 : OMNI OFF, MONO

O : Yes
X : No

Aftertouch	11, 37, A-4,A-9	DECAY Knob / Slider.....	8, 18
Amp Gain.....	37	Multi Trigger.....	27
Filter Freq Shift.....	37	RELEASE Knob / Slider.....	4, 8, 18
Osc Pitch Mod.....	37	SUSTAIN Knob / Slider.....	4, 8, 18
Osc Pitch Shift.....	37	EQ Effect.....	20, 31
AMP Envelope.....	4, 18, 24, 27	Frequency Point.....	20, 31
Amplifier.....	5, 8, 37	Mod Depth.....	31
Arpeggiator.....	19, 38	Mod Rate.....	31
Gate Time.....	38	Sync Initial Position.....	31
Keysync.....	38	Sync Mod Rate.....	31
Latch.....	38	Filter	2, 5, 7, 17, 25, 27, 37
Octave Range.....	38	External Audio.....	27
ON / OFF Button.....	19	FREQUENCY Knob.....	14, 17
Patterns.....	38	KEY TRACK Knob.....	17
Sync Type.....	38	LFO 2 DEPTH Knob.....	17
TEMPO Knob.....	19	MOD ENV DEPTH Knob.....	17
Audio Input.....	2, 27, 36	Overdrive.....	25
Sensitivity.....	36	Q Normalise.....	14, 25
Triggering.....	27, 36	Resonance.....	7, 17, 20
Trim dB.....	36	RESONANCE Knob.....	7, 17
Audio Path.....	5	SLOPE Button.....	7, 17
Breath Control	37	FM Synthesis.....	24, 26, 27
Amp Gain.....	37	Env Attack.....	27
Filter Freq Shift.....	37	Env Decay.....	27
Osc Pitch Mod.....	37	Envelope Amount.....	24
Osc Pitch Shift.....	37	Manual Level.....	24
Chorus Effect	20, 29 - 30	Front Panel Layout.....	13
Feedback.....	30	Global Menu	35
Mod Centre.....	30	Global Sync.....	30, 31, 32, 35
Mod Depth.....	30	Harmonic Content	6
Rate.....	29	Keypad Buttons	3, 13, 14, 22
Sync Initial Position.....	30	LFOs	5, 9, 18, 25 - 26
Sync Rate.....	29	Common To All Voices.....	25 - 26
Type.....	29	DELAY Knob.....	18
Wheel Level.....	30	Delay Multi Trigger.....	25
COMPARE Button.....	4, 13, 22	Keysync.....	25
Comparing Programs.....	4, 22	Select Button.....	18
Connections.....	3	SPEED Knob.....	18
Control Change.....	2, 10, 40 - 43, A-12	Sync Rate.....	26
Cutoff Frequency.....	7	Local control.....	12, 35, A-9
Data Compatibility	2, 33	Master Tune	35
DATA / PROGRAM knob.....	3, 13, 21	Memories.....	3, 9
Delay Effect.....	20, 28	Memory protect.....	4, 33, 34, 36
Feedback.....	28	Menu Always Page One.....	36
Stereo Width.....	28	Menu Mode.....	14, 21, 22, 23, 25, 26, 28, 33, 35, 37, 38
Sync.....	28	MENUS Button.....	13, 14
Time.....	28	MIDI.....	3, 10 - 11, 19, 21, 28, 29, 31, 32, 35, A2-12
Time Ratio.....	28	Channel Messages.....	11
Wheel Level.....	28	Clock.....	11, 19, 28, 29, 31, 32, 35
Demo track.....	4	Clock Input Status.....	35
Display.....	13, 21, 36	Connection.....	3, 10, 12
Display Contrast.....	34	Controllers.....	10
Display Times & Freqs.....	35	Implementation Chart.....	11, A-12
Displaying a Program Edit.....	21	Keyboard Transmit Channel.....	35
Distortion Effect.....	20, 30	Messages.....	10 - 11, A2-12
Level Compensation.....	30	Receive Channel.....	35
Wheel Level.....	30	Sockets.....	3, 10
Editing Sounds	4	Transmit Channel.....	35
Effects.....	2, 20, 28 - 33	Tutorial.....	10 - 11
External Audio Input.....	27, 36	Mixer.....	5, 6, 16
LEVEL Knob.....	20 - 21	LEVEL Knob.....	16
SELECT Buttons.....	20, 21, 22	OSC Knobs.....	16
SELECT LEDs.....	20, 36	SOURCE Button.....	16
Elements Of A Sound.....	5	MOD Envelope.....	8, 18, 27
Envelopes.....	5, 8, 26 - 27		
ATTACK Knob / Slider.....	8, 18		

Index

Mode Selection.....	22	Velocity	10, 26, 35, A2-12
Modulation Wheel.....	13, 28, 29, 30, 34	Velocity Curve.....	35
Calibrating.....	34	Vibrato (setting up).....	37
Noise	6, 16	Vocoder.....	2, 21, 33
Note Messages.....	10, 19	Activating.....	21, 33
NRPNS.....	2, 10 - 11, 42	Sibilance Level.....	33
OCTAVE Buttons (keyboard)	13, 19	Sibilance Type.....	33
Operating System Upgrade.....	11	Stereo Width.....	33
Original Value.....	21	Volume.....	5
Oscillators.....	2, 5, 15, 23 - 24, 37	VOLUME Knob.....	3, 19
DETUNE Knob.....	15	Waveforms	5, 9, 15, 18, 23 - 24
LFO 1 DEPTH Knob.....	15	Noise.....	5
MOD ENV DEPTH Knob.....	15	Sample & Hold.....	18
OCTAVE Button.....	15	Sawtooth.....	5, 18
PORTAMENTO Knob.....	15	Sine.....	5
SEMITONE Knob.....	15	Square.....	5, 18
Select Button.....	15	Triangle.....	5
Start Phase.....	23	WRITE Button.....	4, 13, 22, 33, 34
Sync.....	23 - 24		
Unison Detune.....	23		
Unison Voices.....	23		
VCO Drift.....	23		
Voice Mode.....	23		
WAVEFORM Button.....	15		
Waveforms.....	5, 15		
Outputs.....	3		
PAGE / PROGRAM Buttons	3, 14, 21		
Panning Effect.....	20, 32		
Mod Depth.....	32		
Rate.....	32		
Sync Initial Position.....	32		
Sync Rate.....	32		
Function Display Time.....	36		
Pitch.....	5, 9		
Pitch Bend Messages.....	11, A-12		
Pitch bend Wheel.....	13, 34		
Calibrating.....	34		
Polyphony.....	23		
Portamento.....	15, 23		
Power Socket.....	3		
Preset Programs.....	3, 4, 34, 39		
PROGRAM Button.....	3, 13, 14, 22		
Program Change.....	3, 11, 31, 35, A-12		
Program Edit Mode.....	14, 21		
Program Level.....	26		
Program Select Mode.....	4, 14, 21, 22, 36		
Programs.....	2, 3, 14		
Pulse Width.....	15		
Restoring Global Data	34		
Restoring Programs.....	34		
Reverb Effect.....	20, 29		
Decay Time.....	29		
Type.....	29		
Wheel Level.....	29		
Ring Modulation.....	16		
Saving Global Memory	36		
Saving Sounds.....	4, 22		
Selecting Sounds.....	3		
Sequencers.....	3, 11 - 12, 19, 33		
Synchronisation.....	11, 19, 26, 28, 29, 31, 38		
System exclusive.....	11, 33		
Tone	5		
Utilities Menu	33 - 34		

FCC Information (U.S.A.)

1. IMPORTANT NOTICE: DO NOT MODIFY THIS UNIT! This product, when installed as indicated in the instructions contained in this Manual, meets FCC requirements. Modifications not expressly approved by Novation may void your authority, granted by the FCC, to use the product.
2. IMPORTANT: When connecting this product to accessories and/or another product use only high quality shielded cables. Cable/s supplied with this product MUST be used. Follow all installation instructions. Failure to follow instructions could void your FCC authorization to use this product in the USA.
- 3 NOTE: This product has been tested and found to comply with the requirements listed in FCC Regulations, Part 15 for Class "B" digital devices. Compliance with these requirements provides a reasonable level of assurance that your use of this product in residential environment will not result in harmful interference with other electronic devices. This equipment generates/uses radio frequencies and, if not installed and used according to the instructions found in the users manual, may cause interference harmful to the operation of other electronic devices. Compliance with FCC regulations does not guarantee that interference will not occur in all installations. If this product is found to be the source of interference, which can be determined by turning the unit "OFF" and "ON", please try to eliminate the problem by using one of the following measures:

Relocate either this product or the device that is being affected by the interference.

Utilize power outlets that are on different branch (Circuit breaker or fuse) circuits or install AC line filter/s.

In the case of radio or TV interference, relocate/re orient the antenna. If the antenna lead-in is 300 ohm ribbon lead, change the lead-in to co-axial type cable.

If these corrective measures do not produce satisfactory results, please contact the local retailer authorized to distribute this type of product.

The statements above apply ONLY to products distributed in the USA.

CANADA

The digital section of this apparatus does not exceed the "Class B" limits for radio noise emissions from digital apparatus set out in the radio interference regulation of the Canadian Department of Communications.

Le present appareil numerique n'emet pas de bruits radioelectriques depassant les limites applicables aux appareils numeriques de la "Classe B" prescrites dans le reglement sur le brouillage radioelectrique edicte par le Ministere Des Communications du Canada.

This only applies to products distributed in Canada.

Ceci ne s'applique qu'aux produits distribues dans Canada.

Other Standards (Rest of World)

This product complies with the radio frequency interference requirements of the Council Directive 89/336/EC.

Dette apparat overholder det gaeldende EF-direktiv vedr̄rendareadiost̄j. Cet appareil est conforme aux prescriptions de la directive communautaire 89/336/EC

Diese Ger̄ate entsprechen der EG-Richtlinie 89/336/EC.

Specifications subject to change:

The information contained in this manual is believed to be correct at the time of going to press. However, Novation reserves the right to change or modify the specification without notice or obligation to update existing units.

Part No: MAN-KST-UK
Vers. 1.1a



novation
in music, anything is possible.

Novation EMS Limited
Platinum House 32 Clivemont Road Maidenhead Berkshire England SL6 7BZ
Phone +44 1 628 678520 Fax +44 1 628 671122 E-mail sales@novationmusic.com

Novation USA Limited
Int. Toll-free Tel: 011 - 800 - NOVATION (6682-8466) E-mail salesusa@novationmusic.com

Specification subject to change without prior notice.

www.novationmusic.com