

Liquid Saffire 56

User Guide

Important Safety Instructions

1. Read these instructions.
2. Keep these instructions.
3. Heed all warnings.
4. Follow all instructions.
5. Do not use this apparatus near water.
6. Clean only with dry cloth.
7. Do not block any ventilation openings. Install in accordance with the manufacturer's instructions.
8. Do not install near any heat sources such as radiators, heat registers, stoves, or other apparatus (including amplifiers) that produce heat.
9. Do not defeat the safety purpose of the polarized or grounding-type plug. A polarized plug has two blades with one wider than the other. A grounding type plug has two blades and a third grounding prong. The wide blade or the third prong are provided for your safety. If the provided plug does not fit into your outlet, consult an electrician for replacement of the obsolete outlet.
10. Protect the power cord from being walked on or pinched particularly at plugs, convenience receptacles, and the point where they exit from the apparatus.
11. Only use attachments/accessories specified by the manufacturer.
12. Use only with the cart, stand, tripod, bracket, or table specified by the manufacturer, or sold with the apparatus. When a cart is used, use caution when moving the cart/apparatus combination to avoid injury from tip-over.



13. Unplug this apparatus during lightning storms or when unused for long periods of time.
14. Refer all servicing to qualified service personnel. Servicing is required when the apparatus has been damaged in any way, such as power-supply cord or plug is damaged, liquid has been spilled or objects have fallen into the apparatus, the apparatus has been exposed to rain or moisture, does not operate normally, or has been dropped.

WARNING: To reduce the risk of fire or electric shock, do not expose this apparatus to rain or moisture.

It is important that the apparatus shall not be exposed to dripping or splashing and that no objects filled with liquids, such as vases shall be placed on the apparatus.

- Do not expose this apparatus to drips or splashes.
- Do not place any objects filled with liquids, such as vases, on the apparatus.
- Do not install this apparatus in a confined space such as a bookcase or similar unit.
- Slots and openings in the cabinet are provided for ventilation and to ensure reliable operation of the product and to protect it from overheating. Please ensure adequate space around the apparatus for sufficient ventilation. Ventilation should not be impeded by covering the ventilation openings with items such as newspapers, tablecloths curtains etc.
- The apparatus draws nominal non-operating power from the AC outlet with its POWER switch in the off position.
- The apparatus should be located close enough to the AC outlet so that you can easily grasp the power cord plug at any time.
- An apparatus with Class 1 construction shall be connected to an AC outlet with a protective grounding connection.
- The MAINS plug or the appliance coupler is used as the disconnect device. Either device shall remain readily operable when the apparatus is installed for use.
- No naked flames, such as lighted candles, should be placed on the apparatus.

WARNING: excessive sound pressure levels from earphones and headphones can cause hearing loss.

GB This equipment must be earthed by the power cord

FIN Laitte on liitettävä suojamaadoituskoskettimilla varustettuun pistorasiaan

NOR Apparatet må kun tilkoples jordet stikkontakt

Important Safety Precautions



CAUTION
RISK OF ELECTRIC SHOCK
DO NOT OPEN



CAUTION: TO REDUCE THE RISK OF ELECTRIC SHOCK, DO NOT REMOVE COVER (OR BACK). NO USER-SERVICEABLE PARTS INSIDE. REFER SERVICING TO QUALIFIED SERVICE PERSONNEL.



The lightning flash with arrowhead symbol, within equilateral triangle, is intended to alert the user to the presence of uninsulated "dangerous voltage" within the product's enclosure that may be of sufficient magnitude to constitute a risk of electric shock to persons.



The exclamation point within an equilateral triangle is intended to alert the user to the presence of important operating and maintenance (servicing) instructions in the literature accompanying the appliance.

WARNING: TO PREVENT FIRE OR SHOCK HAZARD, DO NOT EXPOSE THIS APPLIANCE TO RAIN OR MOISTURE

This important safety information is duplicated on the rear surface of the unit chassis

Environmental Declaration

Compliance Information Statement: Declaration of Compliance procedure

Product Identification: Focusrite Liquid Saffire 56
Responsible party: American Music and Sound
Address: 5304 Derry Avenue #C
Agoura Hills,
CA 91301
Telephone: 800-994-4984

This device complies with part 15 of the FCC Rules. Operation is subject to the following two conditions: (1) This device may not cause harmful interference, and (2) this device must accept any interference received, including interference that may cause undesired operation.

For USA To the User:

1. Do not modify this unit! This product, when installed as indicated in the instructions contained in this manual, meets FCC requirements. Modifications not expressly approved by Focusrite may void your authority, granted by the FCC, to use this product.
2. Important: This product satisfies FCC regulations when high quality shielded cables are used to connect with other equipment. Failure to use high quality shielded cables or to follow the installation instructions within this manual may cause magnetic interference with appliances such as radios and televisions and void your FCC authorization to use this product in the USA.
3. Note: This equipment has been tested and found to comply with the limits for a Class B digital device, pursuant to part 15 of the FCC Rules. These limits are designed to provide reasonable protection against harmful interference in a residential installation. This equipment generates, uses and can radiate radio frequency energy and, if not installed and used in accordance with the instructions, may cause harmful interference to radio communications. However, there is no guarantee that interference will not occur in a particular installation. If this equipment does cause harmful interference to radio or television reception, which can be determined by turning the equipment off and on, the user is encouraged to try to correct the interference by one or more of the following measures:
 - Reorient or relocate the receiving antenna.
 - Increase the separation between the equipment and receiver.
 - Connect the equipment into an outlet on a circuit different from that to which the receiver is connected.
 - Consult the dealer or an experienced radio/TV technician for help.

RoHS Notice

Focusrite Audio Engineering Limited has conformed and this product conforms, where applicable, to the European Union's Directive 2002/95/EC on Restrictions of Hazardous Substances (RoHS) as well as the following sections of California law which refer to RoHS, namely sections 25214.10, 25214.10.2, and 58012, Health and Safety Code; Section 42475.2, Public Resources Code.

For Canada To the User:

This Class B digital apparatus complies with Canadian ICES-003
Cet appareil numérique de la classe B est conforme à la norme NMB-003 du Canada.

Contents

Introduction	5
Basics	5
Box Contents	5
Getting Started	6
Hardware.....	7
Back Panel	7
Front Panel.....	8
Installation	9
Audio Set-up in your DAW	9
Liquid Saffire 56 Architecture	10
Saffire MixControl	13
Pre-amp Section	14
Mixer Section	16
Routing Section	20
Monitor Section	22
Device Status Section	25
Settings Menu	26
File Menu.....	28
Liquid Saffire 56 Specifications	28
Troubleshooting.....	30
Pre-amp Emulation Guide	31

Introduction

Thank you for purchasing Liquid Saffire 56, the latest Focusrite professional multi-channel Firewire interface. You now have a complete solution for routing high quality audio in and out of your computer.

This Guide provides a detailed explanation of both the hardware and accompanying control software “Saffire MixControl” to help you achieve a thorough understanding of the product’s operational features. We recommend that both users who are new to computer recording, as well as more experienced users, take the time to read through the user guide so that you are fully aware of all the possibilities that the Liquid Saffire 56 and accompanying software has to offer.

If the main User Guide sections do not provide the information you need, be sure to consult <http://www.focusrite.com/answerbase>, which contains a comprehensive list of common technical support queries regarding the product to date.

Basics

The Liquid Saffire 56 hardware interface provides the means for connecting microphones, line-level signals, instrument-level signals, and digital signals to your computer, which are then routed to your audio recording software / digital audio workstation (referred to throughout this user guide as “DAW”).

The Liquid Saffire 56 features two Liquid Pre-amps. ‘Liquid’ refers to our hybrid microphone pre-amplifier technology, matching high quality Focusrite Mic pre design with meticulously sampled pre-amp emulations transporting classic front-end processing into the digital age.

All audio signals connected to the inputs, plus audio output from your computer programs are routed to the physical outputs for you to connect to an amp and speakers, powered monitors, headphones, analogue/digital mixer, and any other studio equipment that you wish to use. There are also connectors for sending and receiving MIDI.

The accompanying software application, Saffire MixControl provides further recording, routing and monitoring options, as well as the ability to control global hardware settings such as sample rate and synchronisation.

Saffire MixControl software provides mixing and routing to and from the DAW, allowing control over which signals are sent from the sequencer to each output. All inputs on the Liquid Saffire 56 are routed directly to your DAW software for recording, but Saffire MixControl also allows you to route these signals to your monitors so that you can listen to the audio signals with zero latency - before they arrive at your DAW.

Box Contents

Along with your Liquid Saffire 56 you should have:

- 1 - 6 pin to 9 pin Firewire cable (also known as a IEEE1394 cable)
- 1 - IEC Power Cable
- 1 - CD containing software installer software for Mac and Windows

Getting Started

The Liquid Saffire 56 has 2 x 6 pin Firewire ports on the back. You can connect your computer to either Firewire port, and this will work with any of the current Firewire standards and connections; Firewire 400 (6 pin or 4 pin connection); and Firewire 800.

BEFORE YOU CONNECT THE LIQUID SAFFIRE 56 TO YOUR COMPUTER, PLEASE RUN THE INSTALLER. This will ensure that the correct drivers are used, thus preventing any unexpected behaviour.

The Liquid Saffire 56 requires power, supplied via the included power cable.

Saffire PRO 40 units shipped from Summer 2013 come with a 6-pin to 9-pin firewire cable (Firewire 400-800). You may only have a 6-pin Firewire 400 connector on your computer. In this case you will need to purchase a 6-pin to 6-pin firewire 400 cable.

On some PC laptops the firewire connection may be 4-pin firewire. If this is the case, you will need to purchase a 6-pin to 4-pin cable. Alternatively, you may only have a Thunderbolt port on your computer. Firewire is compatible with Thunderbolt through the use of an Apple Firewire to Thunderbolt adapter.

Note:

Firewire considerations - Most computers will generally be equipped with 1 Firewire bus. You may have multiple Firewire ports (connectors) on your computer, but these are all connected to 1 physical chip which controls the bus.

The Firewire bus is limited in the amount of data bandwidth it can handle. Each additional Firewire device connected to the Firewire bus demands additional bandwidth resources, thus increasing the chances of exceeded the total available bandwidth. Consequently, it is recommended that Liquid Saffire 56 run on its own Firewire bus for best performance.

The Liquid Saffire 56 should be able to work along side other devices connected to the same Firewire bus. However, problems may arise depending on which Firewire devices are connected. For example, a Firewire disk used for back-up or a digital camera should not cause any problems, but when streaming audio from a Firewire hard disk or a Firewire DSP box such as Focusrite Liquid Mix, the total Firewire bandwidth may be reached. This will result in audio drop outs, or reduced performance on either the Liquid Saffire 56 or the other connected Firewire device.

For this reason, we would recommend that you use a separate Firewire bus for each Firewire device. This may be a PCI / PCIe card in your desktop, or a PCMCIA or Express card in your Laptop.

Note on FireWire Connection and Disconnection

All Saffire units adhere to the IEEE1394 (FireWire) standard, however it may be the case that the FireWire port on your computer motherboard or FireWire card does not.

Connection and Disconnection from a FireWire port that does not adhere to the IEEE1394 standard may result in permanent damage to both the Saffire and your computer.

To prevent permanent damage:

Connecting your unit(s)

- Ensure that the computer is turned OFF
- Connect the Saffire to your computer
- Attach power supply if necessary
- Turn ON your Saffire
- Turn ON your computer
- Turn ON your monitor speakers

Disconnecting your unit(s)

- Shut down Saffire MixControl
- Turn OFF your monitor speakers
- Turn OFF your computer
- Remove power supply if used
- Disconnect your Saffire

Hardware

Back Panel

The Back Panel provides the majority of input and output

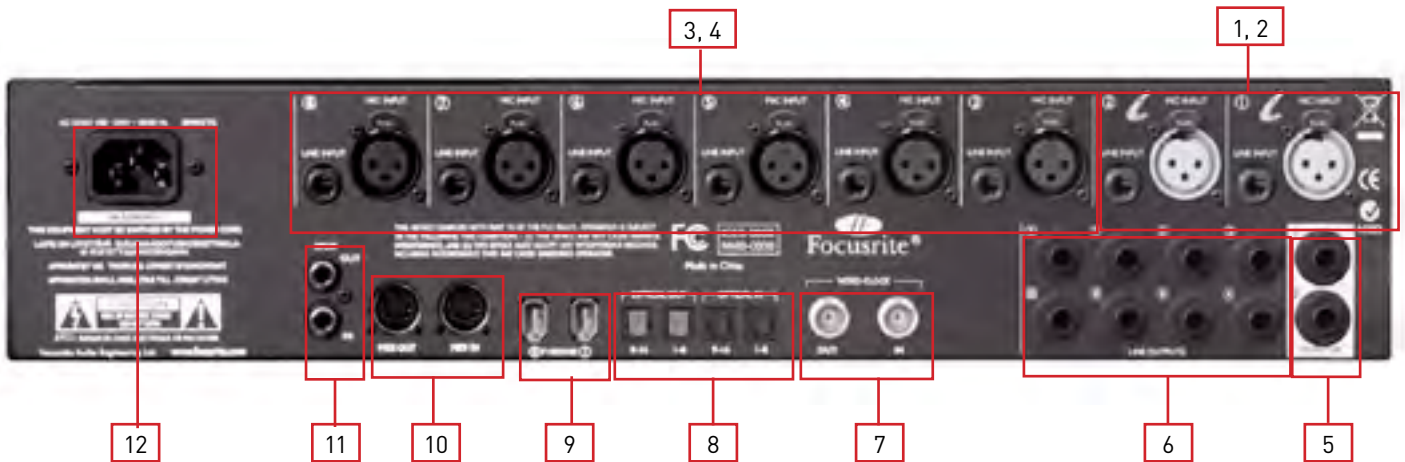

connections on the Liquid Saffire 56.

1. 2 x XLR input sockets for the Liquid Mic Pre-amps (Analogue Mic Inputs 1 & 2).
2. 2 x Jack input sockets for Line level signals (Analogue Line Inputs 1 & 2). *
3. 6 x XLR input sockets for Mic level signals (Analogue Mic Inputs 3 - 8).
4. 6 x Jack input sockets for Line level signals (Analogue Line Inputs 3 - 8). *
5. 2 x TRS jack sockets for balanced outputs for the main monitor mix. *
6. 8 x TRS jack sockets for balanced outputs 3-10. *
7. Word Clock input and output BNC connectors.
8. 2 x Pairs of Optical ADAT input and output sockets. **
9. 2 x IEEE 1394 6 pin Firewire sockets.
10. 2 x Din5 MIDI input and output sockets.
11. 2 x RCA S/PDIF input and output sockets.
12. 1 x IEC Power inlet socket.

* Either 1/4 inch TRS (balanced) or TS (unbalanced) Jack connectors can be used.

** ADAT 2 can also be used as an additional S/PDIF optical i/o.

Front Panel

The Front Panel includes the input connectors for instrument jacks, as well as all the input gain controls and monitoring controls.

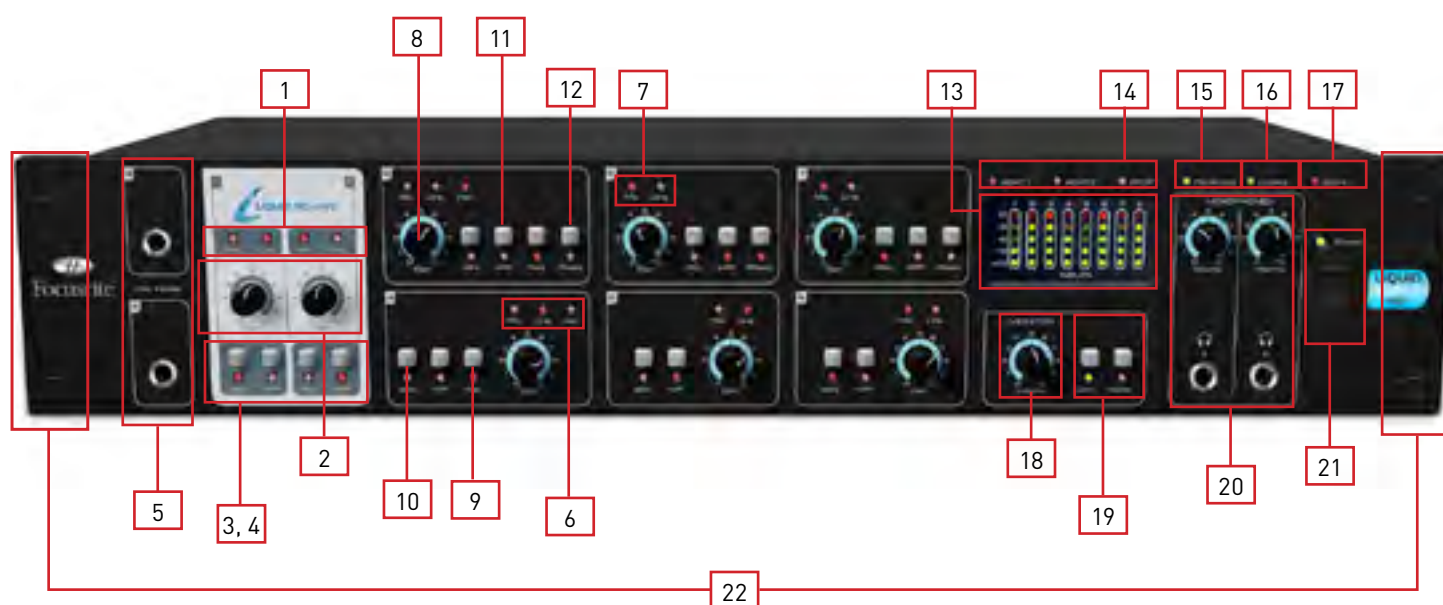

1. Liquid Pre-amps Mic / Line input indication LEDs.
2. Liquid Pre-amps Gain control knobs – use these to set the level of your input signal
3. Liquid Pre-amps +48V phantom power buttons with LEDs.
4. Liquid Pre-amps HPF (High Pass Filter) buttons with LEDs.
5. Instrument Input TS Jacks for channels 3 and 4.
6. Channels 3 and 4 Mic / Line / Instrument input indicator LEDs.
7. Channels 5 to 8 Mic / Line input indicator LEDs.
8. Channels 3 to 8 Pre-amp Gain control knobs - Use these to set the level of your input signal.
9. Channels 3 and 4 Pad buttons with LEDs. Maximum input level without pads is +7dBu, with pads is +16dBu
10. Channels 3 to 8 +48V phantom power buttons with LEDs
11. Channels 3 to 8 HPF (High Pass Filter) buttons with LEDs.
12. Channels 3, 5 and 7 Phase reverse buttons with LEDs.
13. Input signal level meters: 5 LEDs indicate -42, -18, -6, -3, 0dBFS
14. Indicator LEDs for Signal level meters – LED for ADAT 1, ADAT 2, SPDIF. When no LEDs are lit, the meters indicate analogue input levels.
15. Firewire active LED - Lit when the Liquid Saffire 56 is successfully connected to the computer.
16. Synchronisation Lock LED – Lit when Liquid Saffire 56 is either synchronised to its internal clock, or to an external digital input.
17. MIDI In indicator – Lights and flashes when the Saffire recives MIDI data at the MIDI In port.
18. Monitor Level control pot – Can be configured to control any number of the analogue outputs.
19. Monitor Dim and Mute switches with associated LEDs.
20. Headphones 1 & 2 level control and output 1/4 inch jacks.
21. Power switch and LED indicator - Lit when the unit is receiving power and is turned on
22. Removable rack ear covers – remove when fitting to a 19 inch rack.

Installation (Windows and Mac)

We aim to ensure that the latest installation software will be on the disk included with your Liquid Saffire 56. However we strongly recommend that you check for the latest version of software on our website; www.focusrite.com before starting to work with your Liquid Saffire 56 unit.

1. Insert your installer disk into your computer's CD-ROM drive.
2. You should see a window pop up showing the Liquid Saffire 56 installer icon.
3. Double click on the installer icon to begin the installation process.
4. Follow onscreen instructions to complete the installation process.

Once the installation has been completed, your Computer OS should automatically switch its default audio outputs to be the Liquid Saffire 56.

To make sure this is the case:

On Windows, go to Start → Control Panel → Sounds and Audio Devices → Set the input and output to 'Saffire'.

On Mac, go to System Preferences → Sound → Set the input and output to 'Saffire'.

For more detailed setup options on a Mac, go to Applications → Utilities → Audio Midi Set-up.

Audio Set-up in your DAW

The Liquid Saffire 56 is compatible with any DAW that uses ASIO drivers on Windows, and any DAW that uses Core Audio on Mac.

Your DAW software will not automatically switch the device it used to input and output audio.

You must ensure that you select 'Saffire' as the ASIO driver (Windows) or Core Audio driver (Mac) in your DAW's audio set-up page.

Please refer to your DAW's documentation if you are unsure where to select the ASIO / Core Audio driver.

Liquid Saffire 56 Architecture

Liquid Saffire 56 offers more than just simple input and output routing to and from your computer. Saffire MixControl software also allows you to re-route audio signals to any output, and to create custom mixes to be sent to your recording artists, outboard processing equipment, or mixing console.

The following diagrams give an overview of the Liquid Saffire 56 audio paths when set at different sample rates and S/PDIF configurations.

The Hardware Inputs are routed directly to the DAW Inputs. The table below each diagram shows the routing configuration.

44.1kHz / 48kHz Optical as ADAT

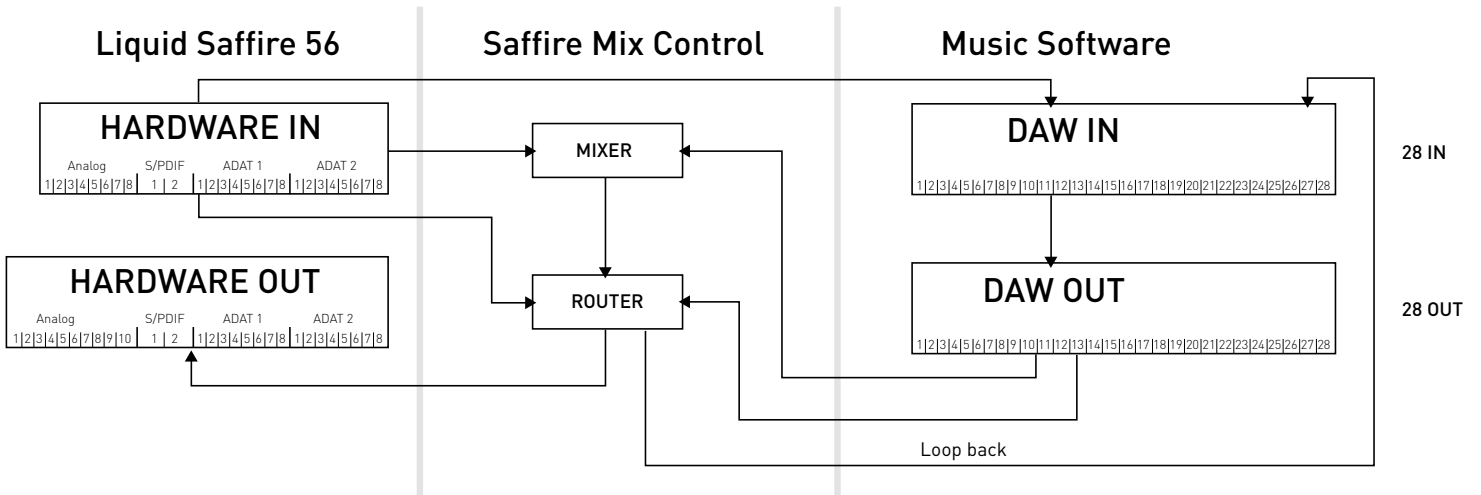

HARDWARE IN	DAW IN
Analogue 1-8	1-8
S/PDIF 1-2	9-10
ADAT 1 1-8	11-18
ADAT 2 1-8	19-26
Loop back 1-2	27-28

44.1kHz / 48kHz Optical as S/PDIF

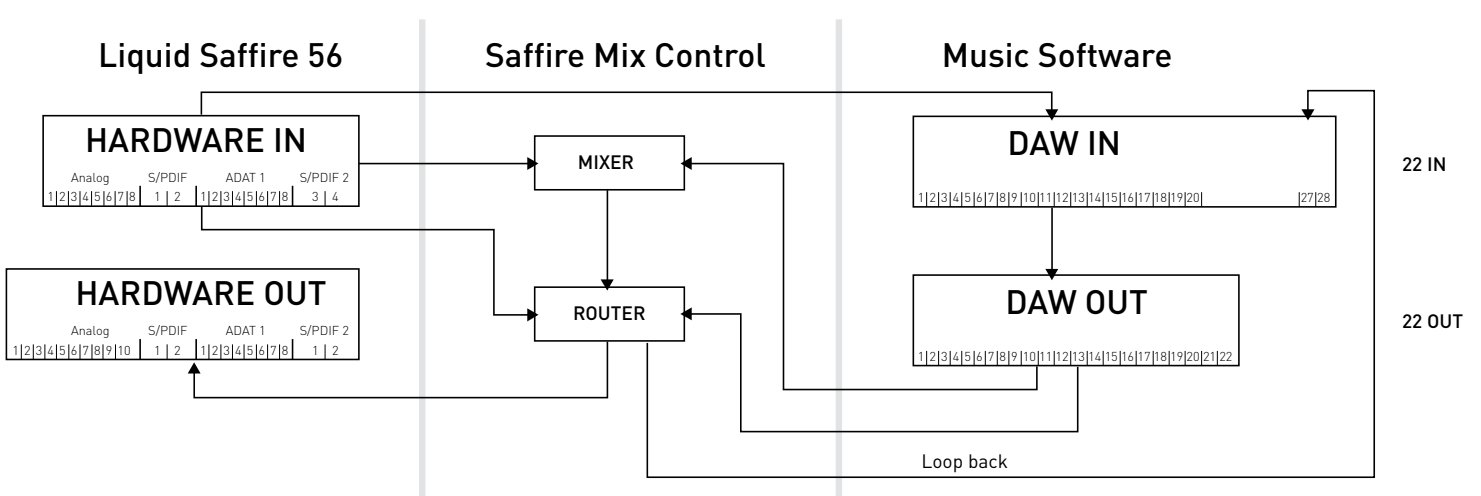

HARDWARE IN	DAW IN
Analogue 1-8	1-8
S/PDIF 1-2	9-10
ADAT 1	11-18
S/PDIF 1-2	19-20
Loop back 1-2	27-28

*DAW IN 21-26 are redundant

88.2kHz / 96kHz Optical as ADAT

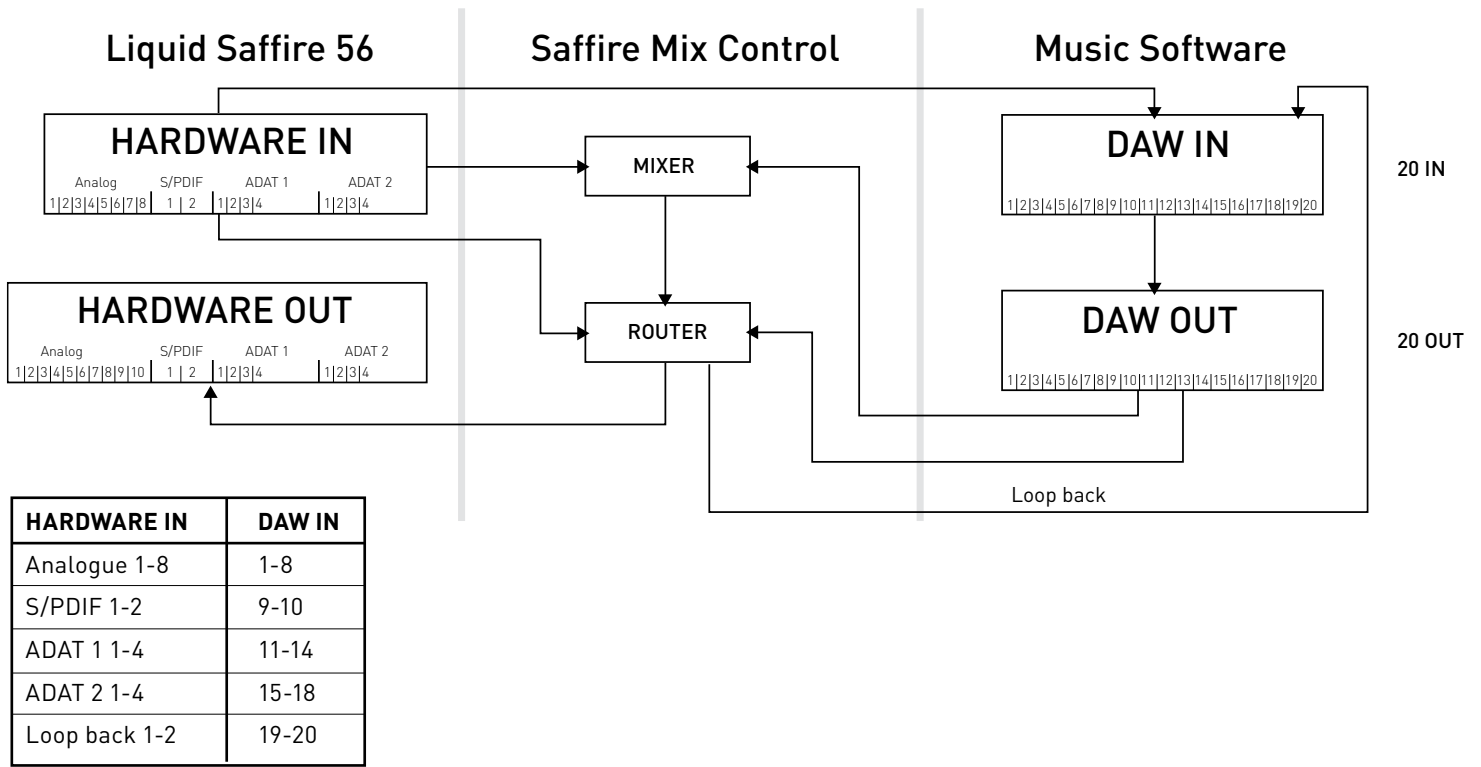

88.2kHz / 96kHz Optical as S/PDIF

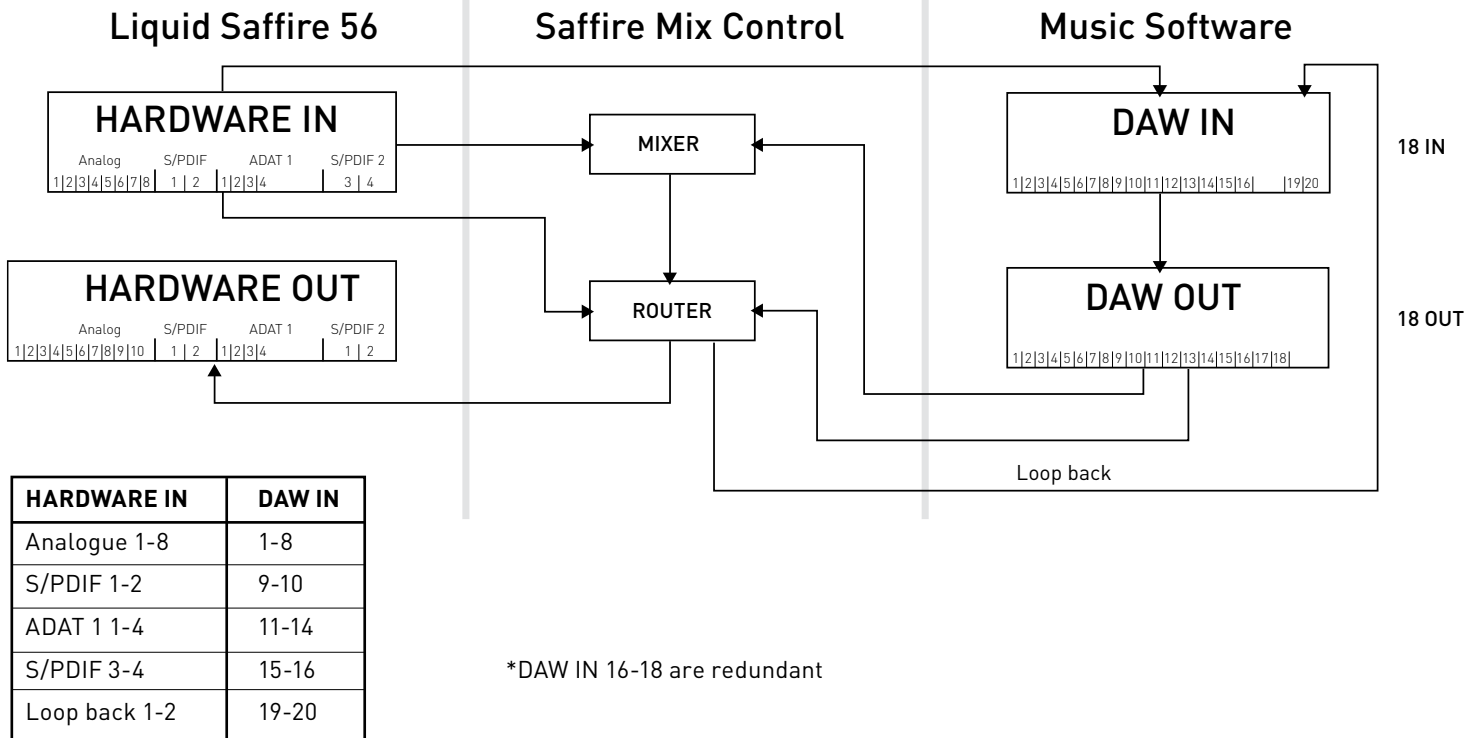

176.4kHz / 192kHz Optical as ADAT

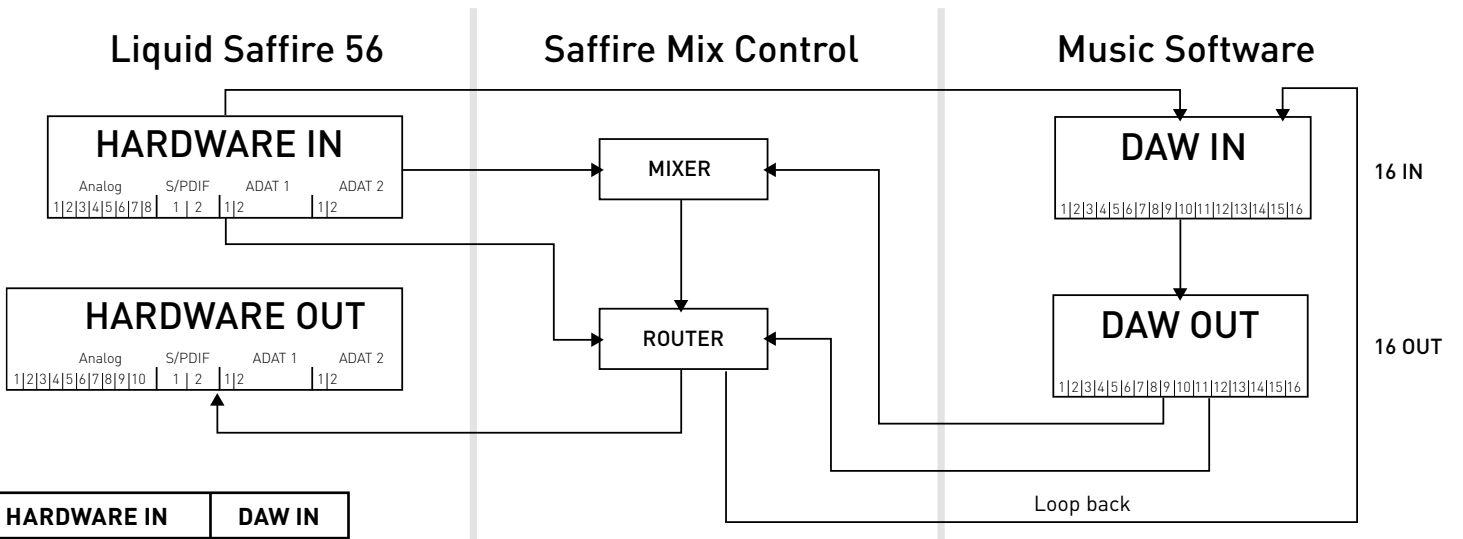

HARDWARE IN	DAW IN
Analogue 1-8	1-8
S/PDIF 1-2	9-10
ADAT 1 1-4	11-12
ADAT 2 1-4	13-14
Loop back 1-2	15-16

Saffire MixControl

The Saffire MixControl software allows flexible mixing and routing of all audio signals to the physical audio outputs, as well as control of output monitor levels. All sample rate selection, digital syncing and buffer size settings (Windows only) are available from Saffire MixControl.

To open Saffire MixControl.

Windows

Start → Programs → Focusrite → Saffire MixControl.

Mac

Open Finder → Applications → Saffire MixControl.

This is how the Saffire MixControl Graphical Interface will appear on your computer.



1. Mixer
2. Selected Mix Tab
3. Mixer Input Channel
4. Selected Mix Output Channel
5. Routing Section / Pre-amp Section (switchable)
6. Monitor Section
7. Device Status Section

Switching between Pre-amp and Routing Sections

The Routing and Pre-amp sections occupy the same space within the Saffire MixControl software interface. Click on this box to switch between each view to access the respective controls

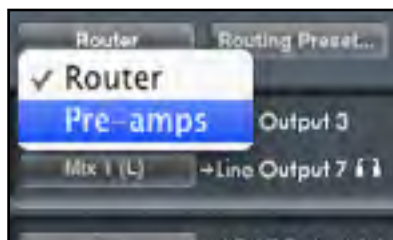

Pre-amp Section

This section is divided into two parts, the left hand side for the 2 Liquid Pre-amps and the right hand side for Pre-amps 3-8.



The Liquid Pre-amps feature high quality Focusrite Analogue microphone pre-amps. After analogue to digital conversion, the audio signal is routed through the Liquid Pre-amps DSP. The analogue circuit in the pre-amp will switch to match the impedance settings of the original pre-amp emulation.

Gain, phantom power and high pass filter controls are available from the front panel of the Liquid Saffire 56 and all additional controls are available in the Saffire MixControl software.

The Liquid Pre-amp section provides control over the following parameters:

- Pre-amp Emulation Select
- Phase Select
- Harmonics Knob
- Pre-amps 3 to 8 Input Signal Source Select

These are described on the next page.

Pre-amp Emulation Select

To select the pre-amp emulation, click on the field to open a drop down list. The following table shows the original units that were used for each pre-amp emulation. The available pre-amp cover a range of vintage and modern, desk and channel strip pre-amps.

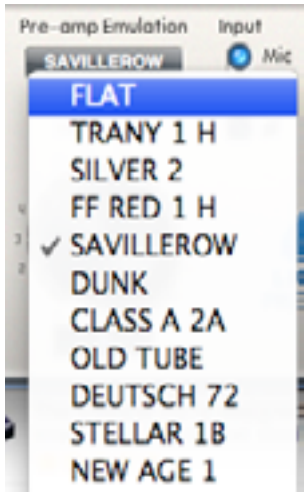

Emulation Title	Emulated Hardware
Flat (Default)	N/A
TRANY 1 H	API 3124+ (high gain setting)
SILVER 2	Avalon VT-737SP
FF RED1 H	Focusrite Red 1 (high gain setting)
SAVILLEROW	Helios Console
DUNK	Manley Slam
CLASS A 2A	Neve 1073 (high impedance setting)
OLD TUBE	Pultec MB1
DEUTSCH 72	Telefunken V72
STELLAR 1B	Universal Audio 610 (low impedance setting)
NEW AGE 1	Millennia HV-3D

* IMPORTANT INFORMATION: FOCUSRITE, the FF logo, LIQUID TECHNOLOGY, SAFFIRE MIX CONTROL and the LIQUID SAFFIRE 56 logo are trademarks of Focusrite Audio Engineering Ltd. DYNAMIC CONVOLUTION is a trademark of Sintefex Ltd. All other product names, trademarks, or trade names are the names of their respective owners, which are in no way associated, connected nor affiliated with Focusrite or its LIQUID SAFFIRE products and which have not endorsed Focusrite's LIQUID SAFFIRE products. These other product names, trademarks, and trade names are used solely to identify and describe the third party products the sonic behaviour of which was studied for the LIQUID SAFFIRE products, and to accurately describe the functionality of the Liquid Mix products. The Liquid Mix products are an independently engineered technology which utilises the patented process of Dynamic Convolution to actually measure examples of the sonic impact of original analogue products upon an audio stream, so as to electronically emulate the performance of the original product studied. The result of this process is subjective and may not be perceived by a user as producing the same effects as the original products studied.

Input / Phase Select



Click the button to switch the Input signal source to Mic (rear panel XLR) or Line (rear panel jack) input.

Note that Line level signals are NOT routed through the Liquid Pre-amp DSP circuit.

Click on the \emptyset button to reverse the phase of the input signal.

Harmonics

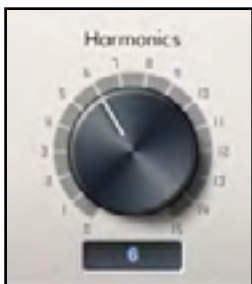

Rotate this knob clockwise to add desirable harmonic distortion to the signal - often perceived as adding 'warmth'. The Harmonics control allows you to add this type of distortion and emulate the subtle variations between analogue devices - sometimes two units of the same type can have different amounts of harmonic distortion. This allows you to create an 'overdriven' sound without having to overdrive the pre-amp.

The exact amount of second, third and fifth order harmonics depends both on the type of pre-amp chosen and the amount of mic pre gain. This is because the amount of each harmonic, with respect to each other, is different for pre-amps with valves compared to those with transistors; and also because the balance of harmonics changes with level.

The result is that a higher gain at the mic pre stage will produce a greater, and hence more noticeable, effect as the harmonics setting is increased.

Pre-amps 3 to 8 Input Signal Source Select

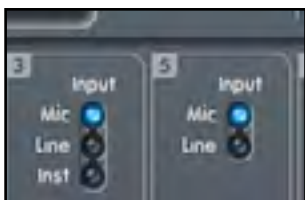

Select the input source for inputs 3-8 by clicking on the corresponding buttons. Inputs 3 & 4 can be set to Mic, Line or Instrument level. Inputs 5 - 8 can be set to Mic or Line level.

Mixer Section

The Mixer Section is used to create mixes for monitoring purposes. The mixes you create do not affect how the audio inputs are routed to the DAW, nor does it affect the audio level of the signal to be recorded. What you set up in the mixer section of Liquid Saffire 56 Control only affects what is heard in the outputs of the mix.

The Mixer includes a total of 16 mixes, each with a maximum of 18 channels in the mix. Up to 16 mono mixes or 8 stereo mixes, (or any combination of mono and stereo mixes,) are available, making up a total of 16 mix channels.

Note that at sample rates of 176.4kHz and 192kHz the number of mixes is reduced to 4 Mono (or 2 Stereo).

Each Mix can contain up to 18 of the possible 40 inputs signals, and each mix can be sent to any number of outputs.

Each mix shares the same source inputs, but all other mixer controls are independent in each mix.

The Input recording levels that are sent to the DAW are therefore those set on the hardware using the Gain knobs.

An example of one use for the mixer is to record multiple artists simultaneously. (e.g. a guitarist and a vocalist are recording at the same time, and you wish to provide them with a backing track and a feed of each other's input signal.)

The guitarist needs to hear mainly the backing track, her guitar, and some vocals. The vocalist needs to hear the backing track, a little of the guitar and lots of his vocals .

A separate mix can be created for each artist with the exact levels that he or she needs. Each artist has his or her own mix on a different mix tab.

Mixer Tab

Each mix can be selected on the corresponding mixer tab.



Input Channel

Here is a picture of 2 mixer input channels. Below is a description of every component of a mixer channel.



Audio source select

When there is no input to a mixer channel, it will display “off”.

Clicking on the “off” region brings up a list of all available inputs that can be fed to the channel. All analogue (labelled ‘Line’) and digital inputs, and DAW outputs are available.

When selecting a source on a stereo channel, if an odd numbered input is chosen for the left channel, the next even number input is auto selected for right, and Vice Versa

Note that if an input has already been taken, it will be greyed out and you cannot select it again. The input needs to be deselected from the track where it is already taken, and then re-selected on the desired track.

To get your sounds from your DAW or other computer applications into the mixer, you should select ‘DAW 1’ and ‘DAW 2’ on a stereo input track.



Pan Slider

A Pan Slider is used to position the audio signal anywhere between the left and right channels.

Moving the horizontal slider from left to right will move the audio signal from left to right within the stereo field, i.e., the signal is faded between two audio outputs such as monitor L and R.

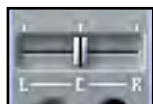

When used with a stereo track, the slider affects the audio signal such that when fully left, only the left channel is heard, and when fully right, only the right channel is heard.

Fader



Use the fader to set the level of your audio signal for monitoring within the current mixer. Click the fader with your mouse and drag to any position. Double click on the fader to set it to 0.

Fader range is from $-\infty$ to +6 dB with the current fader level displayed in the box below.

Meter



The meter shows the signal level of the source input to the channel. The maximum reached signal level is displayed in the box below.

The metering is always pre-fade - showing the level of the signal at the input, therefore the fader level has no effect on the metering.

Clip light

If the red portion at the top of the fader lights up, then the signal level is too high.

You will need to turn down the signal level by either using the gain knobs on the front panel for the analogue inputs, using the gain on the external devices connected to the digital inputs, or using the level controls within the DAW.

Once the gains are lowered, click on the red portion to reset the clip light.

Mute



Pressing this button mutes the signal. Red indicates that Mute is active.

Solo



Pressing this button solos the signal. The level of the fader will affect the level of the soloed signal. Yellow indicates that Solo is active.

PFL (Pre-fade listen)



Pressing this button solos the signal and automatically routes it to Monitor 1 and 2. The level of the soloed signal is pre-fade (i.e. it will not be affected by the level of the fader). Green indicates that PFL is active.

Stereo



Pressing this button combines 2 mono channels into 1 stereo channel.

Track Name

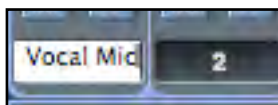

As a default, each track is given a number as a name. Double click to rename the track to something more useful such as 'Vocal Mic'.

Mix Output Channel



The output channel of the mix is where all the input channels are routed to and mixed together. The output channel gives you control of the overall level of the entire mix. You can send a mix to any or all hardware outputs; if a single output is selected this is displayed at the top of the output channel. "Many..." will be displayed if multiple outputs are selected. If the mix is not routed to any outputs then "sel..." will be displayed.

The output channel can be either mono or stereo depending on the status of the stereo button. When the channel is set to stereo, you will see that the tab for that mix doubles in size. This is due to the fact that the stereo version takes up 2 channels of the available total output channel count.

Note that when pressing on the solo button on an output channel, that channel (i.e. the whole mix) is soloed and routed to Monitor outputs 1 and 2. This is a non-latching button.

You can name the current mix by typing the desired name in the text field below the output channel. You will see the name appear in the mix tab. For example, Mix 1 can be renamed "Monitor Mix", and Mix 5 named "Headphone 1 Mix".

To copy an existing mix to another mix, simply click on "Copy Mix To..." and select the mix to which you would like to copy. Note that you can only copy a stereo mix to another stereo mix, and a mono mix to another mono mix. Therefore you must make sure that you have correctly set up the output channels to either stereo or mono before copying the mix.

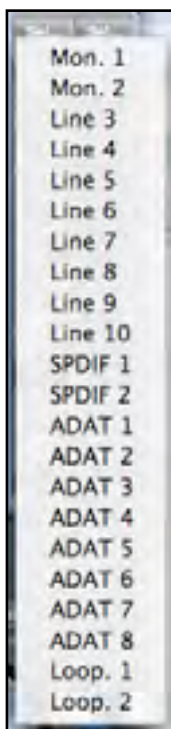

Click on "Sel..." to view a drop down menu of the available output destinations for the selected mix (see the drop down menu in the screenshot on the left side of this page). Select an output in this menu in order to choose the output destination for the selected mix.

Routing Section

The routing section allows you to set up which audio sources are to be routed directly to which physical outputs.

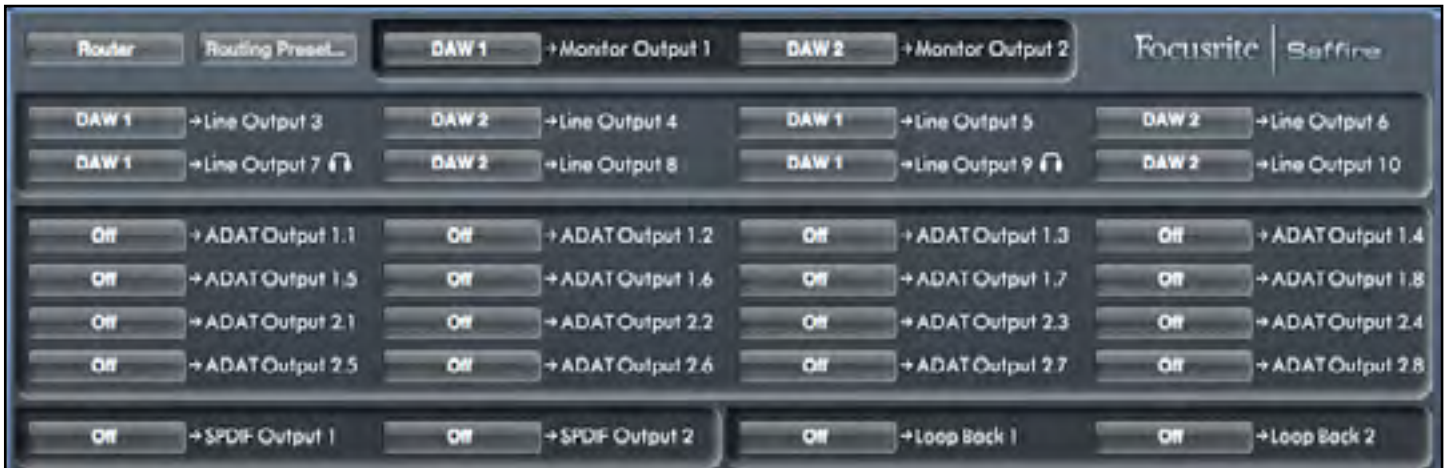

The routing section displays every physical output on the Liquid Saffire 56 and the audio stream to be sent to that output is available for selection in a drop down menu to the left of that output.



Clicking on the box to the left of the output label will bring up a list of all available audio output sources.

The available sources include:

- All input streams (Analogue 1-8, S/PDIF, ADAT 1 & ADAT 2)
- All DAW playback stream (DAW 1 - 28)
- All mixes from the mixer (Mix 1 - 16)

If you have named the mix (by clicking in the track name section – see previous chapter) then this name is displayed as the mix source name.

Note that the routing section is linked to the selection made for the output channel destination set-up in the mixer. If you have outputs pre-assigned from when you created your Mix, you will see the routing selections have been set up. Similarly, if you change the audio source from the routing section, the output of the mix will change automatically.

'Headphones 1' is a copy of line outputs 7 and 8
'Headphones 2' is a copy of line outputs 9 and 10.

When working at sample rates of 88.2kHz or 96kHz, the total number of ADAT channels available drops to 8 channels – 4 per ADAT connection ("ADAT SMUX ") At these sample rates, ADAT channels 5-8 for each ADAT connection are greyed out.

When working at sample rates of 176.4kHz or 192kHz, the total number of ADAT channels available drops to 4 channels – 2 per ADAT connection ("ADAT SMUX II ") At these sample rates, ADAT channels 5-8 for each ADAT connection are greyed out.

Routing Presets

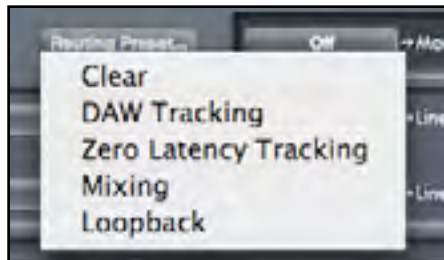

Routing Presets are provided as a starting point for you to create your own routing and mixer set-ups.

These will enable you to quickly set up your routing for recording (monitoring your inputs); mixing (sending signals out to outboard processors or external mixer); or internal looping (routing audio between software applications without leaving the computer).

Clear

This turns off all output routing. This can be used to re-set the routing for when you need to completely restart a configuration, meaning you do not have to manually turn everything off first.

DAW Tracking

'DAW Tracking' is used for the initial recording process. It will automatically output DAW 1 and 2 to be sent to all Line outputs and hence your main monitors (1+2) and to Headphone outputs 1 and 2. All input channels must be monitored from within the DAW application.

Zero Latency Tracking

Zero Latency Tracking is used for the recording process. It will automatically output Mix 1 and 2 to all your Line outputs simultaneously, and hence will route to the main monitors (1+2), and to the Headphone outputs 1 and 2. Line inputs and DAW outputs must be set up in Mix 1 so that you are able to monitor these sources with zero latency. You must also ensure that you are not monitoring the same signals from within your DAW at the same time, otherwise you will be monitoring the same signal twice (once direct from Saffire MixControl AND a second time (with latency) from your DAW.)

Mixing

'Mixing' is used for the mixing process. When sending signals out to a mixer or to external processing hardware, hardware outputs are typically set exactly as they are set in the DAW software. DAW outputs route directly to the line output of the same number. (DAW outputs 1-10 to Monitor Outputs 1-2, Line outputs 3-10.)

Loopback

Use when recording from one software program to another. You can use loopback routing to record audio from your internet browser into your DAW, or to record from one DAW to another. Please refer to the 'Architecture' diagrams on pages 9 to 11 for information on which DAW input channels are used for Loopback.

To prevent any audio feedback, make sure that the DAW you are recording into is not set to monitor its inputs. Alternatively, set the outputs of the DAW into which you are recording to 3 and 4; this allows you to monitor the inputs without feeding the signal back into the record stream.

Monitor Section

The output levels of the monitor outputs and line outputs are configured in the Monitor Section. You can set up your Liquid Saffire 56 so that the hardware 'Monitor' knob on front panel of the Liquid Saffire 56 will control the desired outputs, such as your stereo monitors, your surround sound system. Alternatively the hardware 'Monitor' knob be deactivated for specific outputs e.g. when hardware volume control is required for a pair of monitor speakers, but not for additional outputs being sent to e.g. an external compressor. Additional controls such as mute, dim and mono are available.



Monitor control enable buttons (1 to 10)



The monitor control enable buttons indicate which outputs are controlled by the monitor section on the GUI directly below the ten buttons. The Liquid Saffire 56 can be set up so that you have hands-on control of volume levels, and depending on your monitoring set-up, you may control no speakers, just a single pair of speakers, or up to 10 speakers simultaneously.

(All digital output levels are unaffected by Liquid Saffire 56 control. Use the output levels of the DAW to control digital output levels.)

Each button can be set to 1 of 3 possible states:



Blue - this output is controlled by the below monitor section.



Red - this output is not controlled by the below monitor section and it is muted.



Grey - this output is not controlled by the below monitor section and it is at full level.

To set a button to its Grey state, SHIFT + Click the button.

WARNING: When a Monitor control button is set to 'Grey', the signal routed to that output will be played back at full level. This may potentially result in a very loud signal being sent to your monitor speakers, headphones or other equipment.

Be cautious when setting your levels (in your DAW or the Saffire MixControl Mixer) before setting the monitor button to Grey.

Monitor Presets dropdown menu

These presets allow quick changing of typical monitoring set-ups.

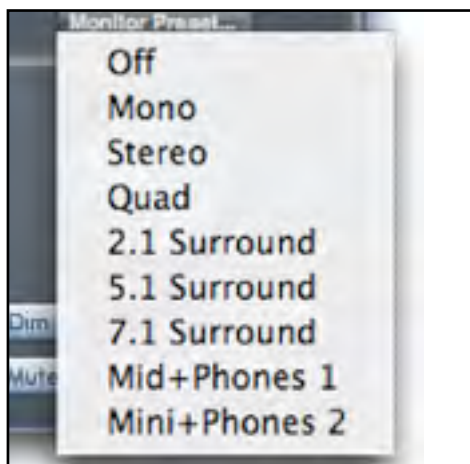

For the monitor presets to work, you must have your speakers connected to the line outputs as shown in either picture below.

Surround Sound Monitoring: (Quad), (2.1), (5.1), (7.1)

- 1 Left
- 2 Right
- 3 Centre
- 4 Sub Woofer
- 5 Left Side
- 6 Right Side
- 7 Left Rear
- 8 Right Rear

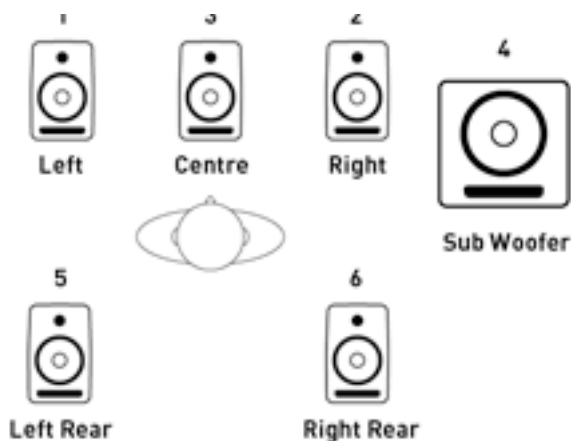

Loudspeaker Set-up: Main Monitors (Stereo), Medium Monitors (Mid + Phones 1), Small Monitors (Mini + Phones 2)

- 1 Left Main
- 2 Right Main
- 7 Left Medium
- 8 Right Medium
- 9 Left Small
- 10 Right Small

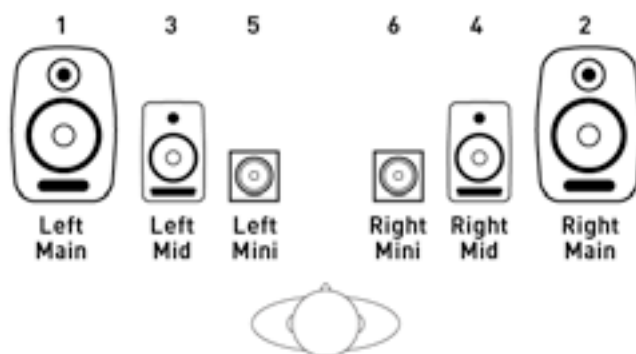

Monitor Presets

Preset Name	Output
Off - no Monitor control buttons enabled, therefore no sound will come out of any analogue output.	
Mono - outputs only to the Centre / mono speaker (Line output 3.) All other channels are muted.	Output - 3
Stereo - outputs to Stereo speakers (Monitor 1 and 2 output.) All other channels are muted.	Outputs - 1,2
Quad - outputs to Monitor 1 and 2 outputs and Line 5 and 6 outputs. All other channels are muted.	Outputs - 1,2,7,8
2.1 Surround - outputs to Stereo speakers (Monitor 1 and 2 output) and Sub (Line output 4).	Outputs - 1,2,4
5.1 Surround - outputs to all 5.1 speakers. All other channels are muted.	Outputs - 1,2,3,4,7,8
7.1 Surround - outputs to all 7.1 speakers. All other channels are muted.	Outputs - 1,2,3,4,5,6,7,8
Mid + Phones 1 - outputs to Mid Speakers and Headphones 1.	Outputs - 7,8
Mini + Phones 2 - outputs to Mini Speakers and Headphones 2.	Outputs - 9,10

Monitor Section Controls

The Monitor section will affect those channels that have been selected for monitor control (indicated with a blue button, see above.)

Monitor level control knob



Set the output level of all assigned outputs using this knob. The output level can be adjusted using the mouse, or from the front panel control, depending on the status of the H/W Control button. The dB display below shows the current level to which the monitor knob is set.

Hardware control button



When lit, the monitor knob on the front panel takes control of the monitor level control knob. Mouse control of the monitor knob is disabled when active.

Note that if the hardware control is switched in and out, and the hardware control position does not match the software position, then the volume knob works in pick-up mode. A volume change will only occur when the position of the hardware knob matches or passes through the position of the software level. This will ensure that there are no sudden unwanted volume increases when the knob is moved.

Dim switch



Attenuates the output level by 18dB.

Mute switch



Mutes the output.

Left Mute switch



Mutes the left output.

Right Mute switch

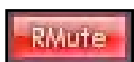

Mutes the right output.

Mono switch



Sums (combines) the left and right signals. The combined signal is then sent out of both Left and Right outputs.

Remember that these dim, mute and mono buttons only affect the outputs selected for control (i.e. Blue) in the monitor control section.

Device Status section



The Device Status section shows information about the sample rate, synchronisation and driver status of the Liquid Saffire 56. The desired sample rate can be set as well as external synchronisation options for using the Liquid Saffire 56 with external digital devices.

Sample rate display

This displays the current Sample rate at which the Liquid Saffire 56 is running. To change the Sample rate, click on the red sample rate value and select 44.1kHz, 48kHz, 88.2kHz, 96kHz, 176.4kHz, or 192kHz.

Note: it is advisable to quit your DAW application BEFORE you make sample rate changes to prevent any undesirable side-effects in your DAW!

Sync Source display

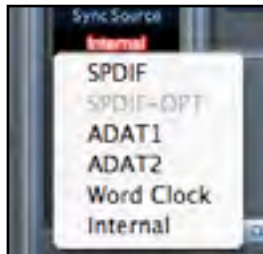

Displays the currently selected sync source (red display) – To change the sync source, click on the red sync source value and select SPDIF, SPDF -OPT, ADAT1, ADAT 2, Word Clock, or Internal.

Sync Status display

Displays “Locked” when the Liquid Saffire 56 has successfully locked to the specified Sync Source.

If “No Lock” is seen, then the unit has been unable to lock to either an external ADAT or S/PDIF signal. If this is the case, then please check that digital cables are secure in their input sockets, and that the external digital devices have been set up as master devices.

Firewire Driver

This should display “Connected” at all times when the Liquid Saffire 56 is connected to the computer via Firewire. If this shows “Disconnected” please check Firewire connections, check that the unit is switched on etc. If it still shows “Disconnected” then restart the computer and then re-start the Liquid Saffire 56.

Unit Name Text Field

Allows naming of the Liquid Saffire 56 unit. Double click in the field and enter your text. Press enter (return) on your computer keyboard to complete.

Settings Menu

This is a dropdown menu containing all of the following items which allow you to set up different global/system configurations.

This is the only part of Saffire MixControl software where there are differences between the Windows and Mac versions.

Mac

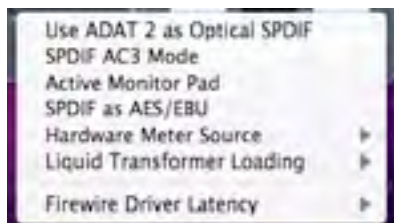

Windows

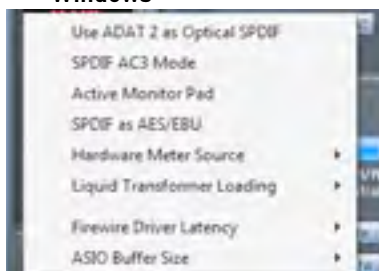

Use Optical ADATs as S/PDIF

Here you can set the format of the optical digital input/output socket. It can either be an ADAT stream or an S/PDIF stream. (Useful for those who have S/PDIF equipment that only has an optical connector.) Note that the audio sent to the optical S/PDIF output is always exactly the same as the audio sent to the RCA output.

S/PDIF AC3

Allows the user to stream AC3 directly via the S/PDIF outputs. (AC3 is encoded 5.1 audio, e.g. from a DVD player, that will be sent via S/PDIF cable (RCA or Optical) to your 5.1 decoder.)

Active Monitor Pad

When ticked, this drops the level of monitors 1 and 2 by 20dB.

This is recommended for set-ups using a stereo pair of Active Monitors.

If you find that for normal listening levels, the Volume monitor knob has to be set at only e.g. 3 or 4, then tick 'Active Monitor Pad' and the volume monitor knob should now be at 6 or 7, thus giving you better control of the output volume level.

Firewire Driver Latency

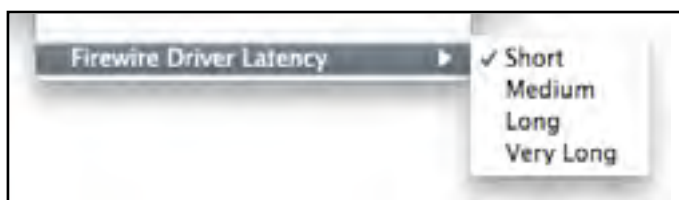

The Liquid Saffire 56 latency performance will be dictated by the Core Audio buffer size specified in your DAW (Mac,) or as set in the ASIO buffer size (Windows.) The Firewire Driver Latency affects the performance of the Core Audio or ASIO buffer settings.

If you are experiencing clicks and pops or audio dropouts, this may be due to certain hardware in your computer that is affecting the performance of audio devices connected via FireWire. Rather than removing and replacing hardware (e.g. your graphics card or wireless internet card) trying a longer Firewire Driver Latency setting may solve the problem.

FireWire Driver In Use

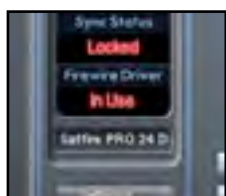

When the Audio Applications are open and using the Saffire PRO 24 driver, the FireWire Driver Status will show 'In Use'. Various Settings will be unavailable until the Audio applications have been closed and the FireWire Driver Status and reverted to 'Connected'.

ASIO Buffer Size (Windows Only)

Set the buffer size of your ASIO driver here.

A small buffer size will in result in lower latency at the expense of increased CPU usage. A high buffer size will result in a higher latency but with lower CPU usage. If you are using lots of virtual instruments and effects processing in your DAW project, and the CPU usage is high, then increase the buffer size to permit lower CPU usage.

Use ADAT 2 as Optical SPDIF	768
SPDIF AC3 Mode	896
Active Monitor Pad	1024
SPDIF as AES/EBU	1280
Hardware Meter Source	1536
Liquid Transformer Loading	1792
Firewire Driver Latency	2048
ASIO Buffer Size	2560
	3072

Hardware Meter Source

Set the LEDs on the Liquid Saffire 56 Front Panel to monitor either the Analogue, ADAT 1, ADAT 2, or S/PDIF inputs.

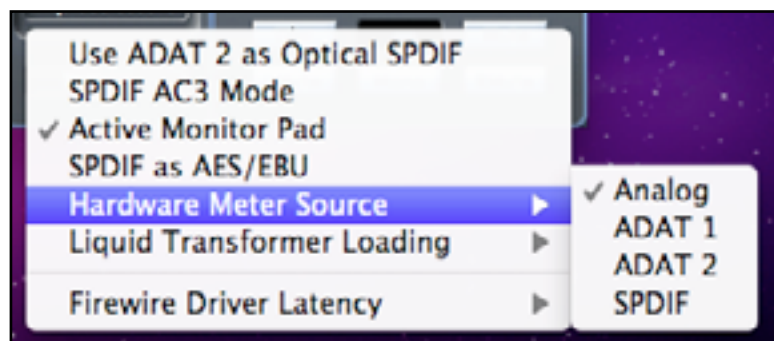

Liquid Transformer Loading

The transformer loading on the Liquid preamps can cause level fluctuation problems with certain microphones. This setting allows you to disable the transformer loading in the Liquid preamps on a per channel basis which should prevent the issue. You should only disable the transformer loading if you are experiencing the level fluctuation problems when using certain microphones.

SPDIF as AES/EBU

This switches the SPDIF input and output on the Liquid Saffire 56 to the AES/EBU standard operating level.

File Menu

Mac

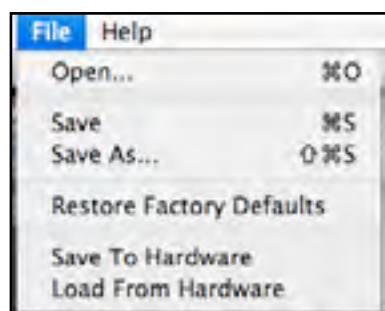

Windows



Open - opens a File open dialog allowing selection of any pre-saved Saffire MixControl set-ups.

Save - opens a File save dialog allowing selection of a location into which your Saffire MixControl set-up can be saved. Subsequent saves overwrite the original file.

Save As - opens a File save dialog allowing selection of a location into which your Saffire MixControl set-up can be saved. Use this option if you want to keep your original saved set-up and create a new one with a different name.

Restore Factory Default - Causes the Liquid Saffire 56 to revert to the original default state in which it left the factory. This can be used to globally reset all mixer, routing, and monitor settings, allowing creation of a new set-up from scratch.

Save to Hardware - This saves the current Saffire MixControl set-up to the Liquid Saffire 56 hardware. If you are moving the Liquid Saffire 56 from one computer to another and want to retain the set-up, then choose this option. Note that Saffire MixControl does not automatically load from hardware (as this would overwrite a current set-up); it must be loaded manually.

Load from Hardware - This loads the saved set-up from the Liquid Saffire 56 hardware into the Saffire MixControl software.

As you can see from the above screen shots, 'Open', 'Save' and 'Save as' all have keyboard shortcuts. These are standard shortcuts for their respective functions, so if you are regularly changing settings for your various sessions, then the shortcuts will reduce your set-up time.

Performance Specifications

Microphone Inputs 1-2

- Frequency Response: 20Hz - 20kHz +/- 0.1 dB
- Gain Range: +13dB to +60dB
- THD+N: 0.001% (measured at 1kHz with a 20Hz/22kHz bandpass filter)
- Noise EIN: 128dB analogue to digital (measured at 60dB of gain with 150 Ohm termination (20Hz/22kHz bandpass filter))
- LIQUID TECHNOLOGY™ Mic-amp emulation*
- Input Impedance: variable, set in software by pre-amp emulation chosen
- Harmonics Distortion Range: 0 to 15 where maximum (15) = 10% of 2nd-, 20% of 3rd- and 10% of 5th-order at 0dBFS (level-dependant distortion)

Microphone Inputs 3-8

- Frequency Response: 20Hz - 20kHz +/- 0.1 dB
- Gain Range: +13dB to +60dB
- THD+N: 0.001% (measured at 1kHz with a 20Hz/22kHz bandpass filter)
- Noise: EIN: 128dB analogue to digital (measured at 60dB of gain with 150 Ohm termination (20Hz/22kHz bandpass filter))
- Input Impedance: 2k ohm

Line Inputs (Inputs 1-8)

- Frequency Response: 20Hz - 20kHz +/- 0.1dB
- Gain Range: -10dB to +36dB
- THD+N: \leq 0.001% (measured with 0dBFS input and 22Hz/22kHz bandpass filter)
- Noise: -90dBu (22Hz/22kHz bandpass filter)

Instrument Inputs (Inputs 3 and 4 only)

- Frequency Response: 20Hz - 20kHz +/- 0.1dB
- Gain Range: +13dB to +60dB
- THD+N: 0.004% (measured with 0dBu input and 20Hz/22kHz bandpass filter)
- Noise: -87dBu (20Hz/22kHz bandpass filter)

Analogue Audio Outputs (Outputs 1-10)

- 10 Electronically Balanced Outputs
- Maximum Output Level (0dBFS): +16dBu
- THD+N: 0.001% (0dBFS input, 20Hz/22kHz bandpass filter)

Digital Performance

A/D Dynamic Range = 110dB (A-weighted), all inputs

D/A Dynamic Range = 110dB (A-weighted), all outputs

Clock Sources:

- Internal Clock
- Sync to Word Clock on SPDIF Input (RCA)
- Sync to Word Clock on optical SPDIF Input (when enabled)
- Sync to Word Clock on ADAT input 1 or 2
- Sync to Word Clock on BNC Word Clock Input

JetPLL™ PLL technology providing superb jitter reduction for class leading converter performance.

Clock jitter: 250 picoseconds

Supported Sample Rates

44.1kHz, 48kHz, 88.2kHz, 96kHz, 176.4kHz and 192kHz

28 x input channels to computer: Analogue (8), SPDIF (2), ADAT (16) and Mix Loop-back (2).

28 x output channels from computer: Analogue (10), SPDIF (2), ADAT (16).

Fully assignable 18 input by 16 output mixer.

FRONT AND REAR CONNECTIVITY

- Analogue Channel Inputs (Inputs 1-8)
- 8 x Mic XLR (channels 1-8) on rear panel
- 8 x Line ¼" TRS (channels 1-8) on rear panel
- 2 x Instrument (Hi-Z) ¼" TRS (channels 3 and 4) on front panel
- Switching between Mic / Line (channels 1-8) / Instrument (channels 3 and 4 only) via Saffire MixControl Application

Digital Channel Inputs (Inputs 9-26) 44.1-192kHz

- Stereo S/PDIF input on RCA
- 16 x ADAT inputs on two Optical Connectors, reduces to 8 inputs at 88.2/96kHz and 4 inputs at 176.4/192kHz
- Optical Input 2 can be switched to S/PDIF 3/4 in software preferences (ADAT Input 2 disabled)

Analogue Audio Outputs (Outputs 1-10)

- 10 x ¼" TRS Jacks
- 2 x monitor mix outputs (anti-thump circuitry) on ¼" TRS Jack (Outputs 1 and 2 only)
- Stereo Headphones Mix 1 on ¼" TRS (also routed to Outputs 7 & 8)
- Stereo Headphones Mix 2 on ¼" TRS (also routed to Outputs 9 & 10)

Digital Channel Outputs (Outputs 11-28) 44.1-192kHz

- Stereo S/PDIF Output on RCA
- 16 x ADAT Outputs on two Optical Connectors, reduces to 8 outputs at 88.2/96kHz and 4 outputs at 176.4/192kHz
- Optical Output 2 can be switch to be a copy of the SPDIF RCA output (ADAT Output 2 disabled)

Other I/O

- Word Clock Input and Output on BNC
- 2 x 6-pin Firewire S400 sockets
- 2 x Standard 5-pin DIN MIDI connectors: In and Out
- IEC mains power input connector (universal input voltage)

Front Panel Indicators

- 8 x 5 segment input meters (switch-able source via Saffire MixControl), -42, -18, -6, -3 and 0dBFS
- "Lock" Indicator
- "Host Connected" Indicator
- MUTE Switch and LED
- DIM Switch and LED
- MIDI In data activity LED
- ADAT1, ADAT2 and SPDIF LED to indicate meter sources
- Input source selection LED for each channel (Mic / Line / Instrument)

Weight and Dimensions

- 2U Rack Mount unit: approx. 48 x 9 x 23cm (W x H x D)
- Weight: 4kg

* IMPORTANT INFORMATION: FOCUSRITE, the FF logo, LIQUID TECHNOLOGY, Liquid Saffire 56 logo are trademarks of Focusrite Audio Engineering Ltd. DYNAMIC CONVOLUTION is a trademark of Sintefex Ltd. All other product names, trademarks, or trade names are the names of their respective owners, which are in no way associated, connected nor affiliated with Focusrite or its Liquid Saffire 56 product and which have not endorsed Focusrite's Liquid Saffire 56 product. These other product names, trademarks, and trade names are used solely to identify and describe the third party products the sonic behaviour of which was studied for the Liquid Saffire 56 product, and to accurately describe the functionality of the Liquid Saffire 56 product. The Liquid Saffire 56 product is an independently engineered technology which utilises the patented process of Dynamic Convolution to actually measure examples of the sonic impact of original analogue products upon an audio stream, so as to electronically emulate the performance of the original product studied. The result of this process is subjective and may not be perceived by a user as producing the same effects as the original products studied.

Troubleshooting

For all troubleshooting queries, please visit the Focusrite Answerbase where there are articles covering numerous troubleshooting examples. www.focusrite.com/answerbase.

E & O.E.

Pre-amp Emulation Guide

Emulation	Original	(Origin) Serial	Impedance	Description
TRANY 1 H	API 3124+	(US) serial # 10149	1150 ohms (quoted 1500)	The API 3124 is a four channel rack pre-amp. The microphone pre-amp design is the same as one utilised in all API mixing desks. It is a Op-amp pre-amp design with RE 115 K input transformer and the same output transformer used in the API EQs. The API 3124 is a popular choice for drum kit recordings but will provide a great sound from classical recording to distorted guitars.
SILVER 2	Avalon VT-737SP	(US) serial # 12545	807 ohms (quoted 850)	The Avalon VT-737SP is a fully featured 2U channel strip. The unit features a microphone input transformer. The pre-amp is a high-voltage Class A design featuring two dual vacuum tubes resulting in a low noise, high headroom circuit.
FF RED 1 H	Focusrite Red 1	(UK) serial # F07858T	1050 ohms (quoted 1200)	The Red 1 is the classic Focusrite high end sound. The Red 1 is a hand-built rack unit using the same pre-amp design as found in the Focusrite Forte Console. The Red range was launched in 1992 and are still sold to this day. The high performance standard has won numerous awards over the years, including 2 TEC awards.
SAVILLEROW	Helios Console	(UK) serial # unknown (Colour Green)	1541 ohms (quoted unknown)	The Legendary Helios Electronics Ltd Olympic mic-pre has achieved a renowned status through its use by the Beatles, Rolling Stones, Bob Marley, Led Zeppelin and so on. The mic pre-amp is extremely open and uses an input transformer that is based on the highly desirable Lustraphone (Olympic Sound Studios) model. It has a unique '70s sonic footprint thanks to all its discrete component design (not a chip in sight!).
DUNK	Manley SLAM	(US) serial # SLAM120	1806 ohms (quoted 2000)	SLAM! stands for "Stereo Limiter And Mic pre". This is the pre-amp from the legendary two channel Limiter and Pre. It is a Class A Tube design with plenty of gain. The tube pres gives a clean and clear sound with great results for both aggressive singers and, with enough gain, for soft singers or low output mics.
NEW AGE 1	Millennia HV-D3	(US) serial # D-367	5455 ohms (quoted 6200)	The Millennia HV-3D is an eight channel, 2U rack pre-amp. The pre-amp design is transformerless high-voltage discrete transistors. This design is perfect for very detailed and transparent recordings.
CLASS A 2A	Neve 1073	(UK) serial # 7172K	1050 ohms (quoted 1200)	The Neve 1073 was first released in 1970 and has been used on countless hit records to this day. It is perhaps one of the most sought after mic pre amps in the world. It is a hand build and hand wired transformer based class A pre-amp.
OLD TUBE	Pultec MB-1	(US) serial # 6846	153 ohms (quoted 150)	The Pultec MB-1 was designed for use in radio and television broadcast, recording studios, P.A. systems and test lab environments. The Pre amp features a very minimal circuit design based on input and output transformers and tube gain stage. The MB-1 uses a fixed gain structure, meaning that resistors needed to be soldered into the circuit to change the pre-amp gain.
DEUTCH 72	Telefunken V72	(DE) serial # 2107.	756 ohms (quoted unknown)	The Telefunken is a vintage Valve pre-amp originally built in the late 1940s. The V72 was actually modelled on the V41 (developed in 1928). It was originally developed for German Radio stations but was later taken up by most of the European Recording Companies like EMI, Decca/Telefunken. The V72 is a tube based pre-amp offering fixed gain stages, and is perfect for bringing the analogue back to digital sounds.

Notes