

Introduction

Thank you for purchasing the ISA 430 MKII brought to you by the Focusrite team – Ian, Trevor, Peter, Martin, Tom, Mick, Phil, Chris G, Micky, Pauline, Melissa, Chris W, Rob J Snr, Simon J, Vernon, Giles, Rob J Jnr, Mick G, Tim, Dave, Paul and Simon.

The chaps at Focusrite are a jolly hard working bunch and take a great deal of pride in designing, building and delivering products which are considered to be the best audio units around; we hope your new Focusrite unit lives up to that reputation and that you enjoy many years of productive recording. If you would like to tell us about your recording experiences, please email us at: sales@focusrite.com



The Focusrite Team

Contents

Introduction.....	1
Contents.....	1
Important Safety Instructions	1
Power Connections	1
Rear Panel Connections.....	2
ISA 430 MKII Front Panel Controls	3
Metering.....	3
Input Stage.....	4
EQ Module.....	5
Compressor.....	6
Gate.....	8
De-Esser	9
Output	9
Inserts and Routing Matrix.....	10
Soft Limiter	13
Optional Analogue to Digital Converter (ADC)	13
Digital Output Front Panel Controls.....	14
ADC Configurations.....	15
Mic Pre-amp Input Impedance.....	16
Applications.....	17
FAQs	21
Specifications	24
Accuracy.....	26
Copyright.....	26
Warranty	26
Reset Sheet.....	27
Focusrite Distributors.....	28

Important Safety Instructions

Please read all of these instructions and save them for future reference. Follow all warnings and instructions marked on the unit.

Please leave a 1U rack space above and below this device.

- Do not obstruct air vents in the rear panel. Do not insert objects through any apertures.
- Do not use a damaged or frayed power cord.
- Unplug the unit before cleaning. Clean with a damp cloth only. Do not spill liquid on the unit.
- Unplug the unit and refer servicing to qualified service personnel under the following conditions: if the power cord or plug is damaged; if liquid has entered the unit; if the unit has been dropped or the case damaged; if the unit does not operate normally or exhibits a distinct change in performance. Adjust only those controls that are covered by the operating instructions.
- Do not defeat the safety purpose of the polarised or grounding type plug. A polarised plug has two blades with one wider than the other. A grounding type plug has two blades and a third grounding prong. The wider blade or the third prong are provided for your safety. When the plug provided does not fit into your outlet, consult an electrician for replacement of the obsolete outlet.

WARNING: THIS UNIT MUST BE EARTHED BY THE POWER CORD.

UNDER NO CIRCUMSTANCES SHOULD THE MAINS EARTH BE DISCONNECTED FROM THE MAINS LEAD.

This unit is capable of operating over a range of mains voltages as marked on the rear panel. Ensure correct mains voltage setting and correct fuse before connecting mains supply. Do not change mains voltage settings while mains supply is connected. To avoid the risk of fire, replace the mains fuse only with the correct value fuse, as marked on the rear panel. The internal power supply unit contains no user serviceable parts. Refer all servicing to a qualified service engineer, through the appropriate Focusrite dealer.

Power Connections

There is an IEC mains lead supplied with the unit which should have the correct moulded plug for your country. The wiring colour code used is:

For units shipped to the USA, Canada, Taiwan and Japan:
Live - Black **Neutral** - White **Earth** - Green

For units shipped to any other country:
Live - Brown **Neutral** - Blue **Earth** - Green and Yellow

Rear Panel Connections

(Optional A/D Card shown fitted)

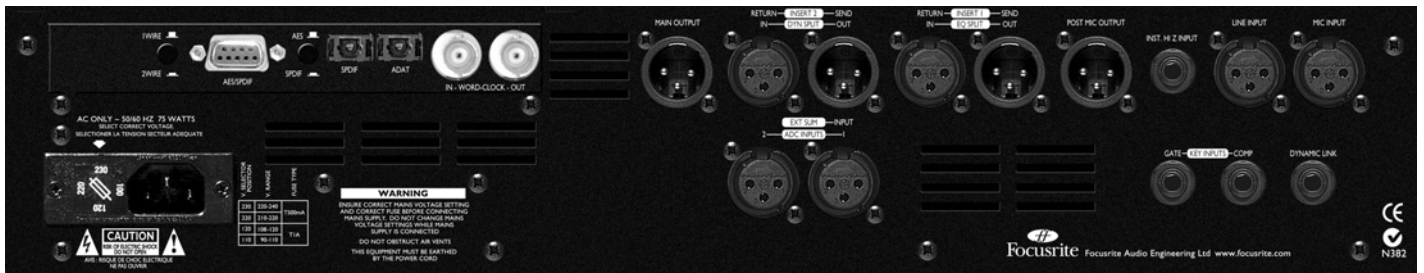

XLR (Audio) Inputs and Outputs

All 3-pin XLR audio connectors (main and post-mic outputs, mic, line & ADC inputs, insert sends & returns) are wired as follows:

- Pin 1 Screen/chassis
- Pin 2 Audio 0°
- Pin 3 Audio 180°

INST. HI Z INPUT

1/4" jack wired as follows:

- Tip Audio 0°
- Sleeve Screen/chassis

KEY INPUTS

1/4" jack wired as follows:

- Tip Audio 0°
- Ring Audio 180°
- Sleeve Screen/chassis

DYNAMIC LINK

1/4" jack wired as follows:

- Tip Compressor sidechain link
- Ring Gate sidechain link
- Sleeve Screen/chassis

MIC/LINE/INST INPUT

Any one of these inputs may be used as the main input to the ISA 430 MKII's main input. Signals routed to these inputs are referred to as the 'Internal' or 'Int' signal path.

INSERT RETURN 1

This is used as the insert 1 input point, or as the input to the EQ modules in 'EQ Split mode' (see 'EQ Split' diagram on page 10).

INSERT SEND 1

This is used as the insert 1 output point, or as the analogue output from the EQ module in 'EQ Split mode' (see 'EQ Split' diagram on page 10).

INSERT RETURN 2

This is used as the insert 2 input point, or as the input to the dynamics modules in 'Dyn Split mode' (see 'Dynamics Split' diagram on page 10).

INSERT SEND 2

This is used as the insert 2 output point, or as the analogue output from the dynamics module in 'Dyn Split mode' (see 'Dynamics Split' diagram on page 10).

POST-MIC OUTPUT

This is used as an output from the point immediately after the Phase section (i.e. before EQ and dynamics modules) allowing direct recording of mic, line or instrument inputs. It provides a direct-to-tape, ultra-short signal path output. Taking a signal from the POST-MIC OUTPUT does NOT interrupt a signal routed from the mic-pre to the EQ, dynamics etc., so a direct feed to tape can be achieved whilst simultaneously allowing processing of the same source.

ADC INPUT 1

ADC Input 1 is used to route an external signal directly to the optional A/D card via the limiter. When selected using the ADC Input 1 button on the front panel, ADC Input 1 replaces the internal **processed** signal being fed to the left side of the A/D card (i.e. whatever is connected to the mic, line or instrument input no longer routes to the ADC). For further detail see ADC Input 1 & 2 on page 13. It also allows a signal to be summed with the processed signal from the unit by pressing the Ext Sum switch and using the Ext Level controls. This signal can be routed to the A/D card and main output (See ADC Input 1 & 2 on page 13.)

ADC INPUT 2

ADC Input 2 is also used to route an external signal directly to the optional A/D card via the limiter. When selected using the ADC Input 2 button on the front panel, ADC Input 2 replaces the internal **unprocessed** signal being fed to the right side of the A/D card (i.e. whatever is connected to the mic, line or instrument input). This still allows the processed signal (i.e. whatever is connected to the mic, line or instrument input) to route to the left side of the A/D card. Hence there are four possible setups for the ADC 1 & 2 input switches. (See ADC Input 1 & 2 on page 13.)

MAIN OUTPUT

This output is used as the main analogue internal signal output, and is fed by whatever is connected to the MIC INPUT, LINE INPUT or INST INPUT, after this signal has been routed through the processing modules.

DYNAMIC LINK

You can connect two ISA 430 MKII units (using a standard TRS 1/4" jack-to-jack lead between the DYNAMIC LINK sockets) to allow both the compressor and gate sections to behave as stereo pairs of processors. When connected in this way, the compressors and gates behave as single stereo devices. Both units respond to the higher of the two input signal path levels. (The EQ channels can be matched visually or aurally to be used as a stereo pair if required.) Hence, to drive the compressors and gates as stereo pairs, set the threshold pot of one of the compressors and one of the

gates to maximum (fully clockwise). The second unit will then act as 'master', allowing one set of parameter changes to affect both compressors or gates identically. NB: The de-essers are not linked.

Retrofitting the Optional A/D Card

The optional A/D card can be retrofitted to a standard ISA 430 MKII at any time. Full fitting instructions for this option are included with the Card.

ISA 430 MKII Front Panel Controls

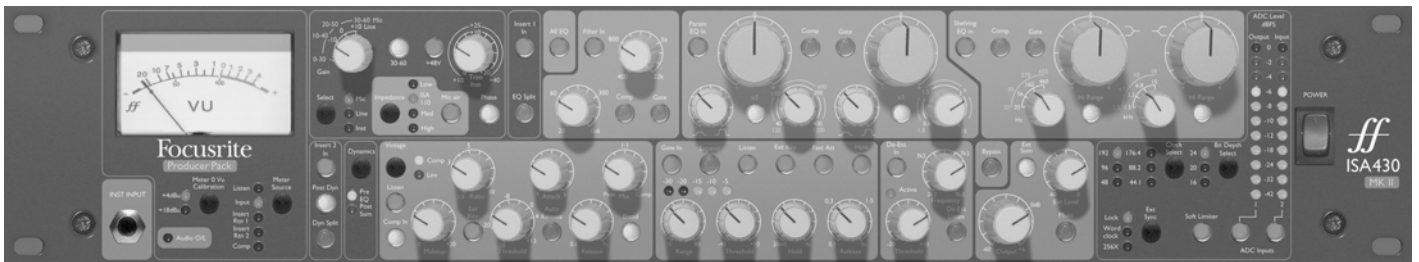

Power

Applies power to the unit. Turn on the ISA 430 MKII before powering up devices to which the outputs are connected.

Inst Input

Unbalanced instrument sources may either be connected via the rear panel INST. HI Z INPUT, or via this duplicated front panel jack. If both are connected, the front connection overrides the rear connection. No DI box is required.

Metering

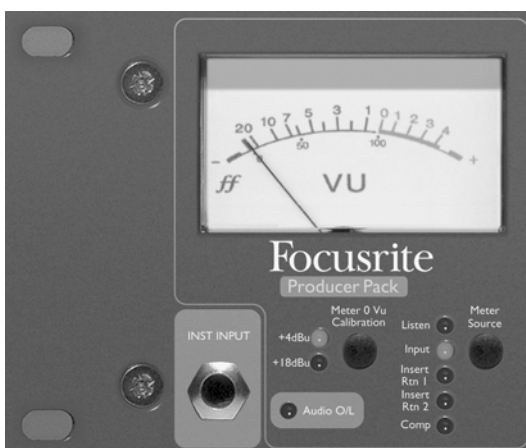

Meter Source

The VU meter can display input level, Insert 1 return level, Insert 2 return level, compressor gain reduction or sidechain Listen level. Press the Meter Source button to step through Input, Insert Rtn 1, Insert Rtn 2 and Comp sources as indicated by the corresponding LEDs. The sidechain Listen level will automatically be displayed on the

VU meter when the Listen switches are pressed in the compressor, gate or de-esser sections. The Listen LED will also light when any of these switches are selected.

Meter 0VU Calibration

The metering calibration for the input level and insert return levels can be shown over two different ranges:

- 0VU corresponds to +4dBu.
- 0VU corresponds to +18dBu.

Either can be selected via the Meter 0VU Calibration button. For the compressor, the meter indicates the amount of gain reduction applied, from 0VU (no compression) to -20VU (corresponding to 20dB of gain reduction). NB: The effect upon 'Listen' of calibration is similar to that on input and insert returns. However, as the signal being monitored by the listen circuit is a sidechain source, the meter acts more as a visual indication of the attack and decay of a signal, rather than true level.

Listen LED

This illuminates when Listen is selected on the compressor, expander/gate or de-esser, and indicates that the unit is monitoring the selected sidechain frequencies. N.B. When attempting to listen to the dynamics in 'Split Dynamics' mode, pressing the Listen switch will only result in visual monitoring; as the dynamics are split from the monitoring path, they can be viewed in the meter but not heard.

Audio O/L LED

This LED illuminates when the peak signal level reaches or exceeds +20dBu, or when the peak signal level reaches 6dB below the clip point. The signal is monitored at five points: post-the input gain Trim, post-Insert 1, post-the EQ

module, post-Insert 2, and post-the Dynamics module (since each module could cause clipping if incorrectly set up). Occasional short-duration peaks which may cause the LED to blink will not normally cause audible distortion, but if the LED is lit constantly, the level in the appropriate module should be reduced to prevent overloading.

Digital Output Meters



Two LED bargraph meters monitor the level being fed to the output (left meter) and input (right meter) of the unit.

They also display the channels of the optional ADC card when the ADC Input 1 and ADC Input 2 switches are selected. The meters provide a wide range from -42dBFS (-20dBu) to 0dBFS ($+22\text{dBu}$).

The output meter monitoring point is just before the ADC input; this means that if the limiter is switched in the action of the limiter can be seen on the meter. This monitor point is also post-the output level control. When ADC Input 1 is selected the meter is fed from ADC Input 1. The input meter monitoring point is post-the phase switch. When ADC Input 2 is selected the meter is fed from the ADC Input 2.

Input Stage

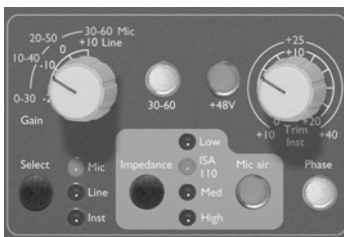

Three input options are provided to give compatibility with mic, line or instrument sources. An immediately-post-input-stage, balanced output (POST-MIC OUTPUT) is provided on

the rear panel giving an ultra-short signal path to allow for the cleanest possible recordings. N.B. The POST-MIC OUTPUT can be used in conjunction with the main output, allowing the user to record a dry signal for archive/safety purposes, at the same time as recording the processed output.

Select

Pressing Select steps through each of the three inputs as indicated by the corresponding LEDs. When the Mic LED is lit, the mic input is active etc. Only one of the Mic, Line or Instrument inputs can be used.

Mic Input Gain

With the mic input selected, the user has access to the full gain range in 10dB steps from 0dB to +60dB (yellow

legend). The gain range is split between two gain modes depending upon the status of the 30-60 switch:

Mode 1: Mic Gain Range 0-30

With the 30-60 switch off, the rotary gain knob operates over a gain range of 0dB to +30dB, the level of gain chosen being indicated on the front panel by the outer arc of yellow numbers around the gain knob.

Mode 2: Mic Gain Range 30-60

With the 30-60 switch on (illuminated), the rotary gain knob operates over a gain range of 30dB to 60dB, the level of gain chosen being indicated on the front panel by the outer arc of yellow numbers around the gain knob.

An additional 20dB of gain can be applied to the signal after the Mic/Line gain knob using the Trim knob. See Trim control text below for full explanation.

Line Input Gain

With the line input selected, the user has access to gain settings ranging from -20dB to $+10\text{dB}$, indicated on the front panel by the arc of white numbers around the gain knob. The 30-60 switch is inactive when the line input is selected, as the gain range for Line level inputs is restricted to -20dB to $+10\text{dB}$ in 10dB steps.

An additional 20dB of gain can be applied to the signal after the Mic/line gain knob using the Trim knob. See Trim control text below for full explanation.

Instrument Input Gain

With the instrument input selected, gain is applied to the input signal by using the Trim control only, which allows $+10\text{dB}$ to $+40\text{dB}$ of gain range. The level of gain chosen is indicated on the front panel by the outer arc of yellow numbers around the gain knob. This input is suitable for high impedance sources such as guitar or bass pickups (which may be connected directly without the need for an external DI box), or vintage synthesizers with high impedance outputs.

Trim

The Trim control provides additional variable gain of 0dB to +20dB when mic or line inputs are selected. The level of gain chosen is indicated on the front panel by the inner arc of white numbers around the gain knob. The additional 20dB of gain that can be applied to the Mic or Line signal is very useful for two reasons:

When high gain is required

The trim used in conjunction with the Mic gain of 60dB will give a total of up to 80dB of pre-amp gain, making it very useful for getting good digital recording levels from very low output devices, such as dynamic and ribbon microphones.

Gain adjustment during recording

When small amounts of gain adjustment are needed to correct for performance level variations during recording, use the trim knob rather than the stepped Mic/Line gain knob, as switching the 10dB gain steps will be much too

intrusive. It is therefore good practice to apply some Trim gain before using the 10dB stepped gain knob to find the optimum recording level so that the Trim control can be used to gently add or take away gain later, if so required.

+48V

Pressing the +48V switch provides +48V phantom power, suitable for condenser microphones, to the rear panel XLR microphone connector. This switch does not affect the other inputs. If you are unsure whether your microphone requires phantom power, refer to its handbook, as it is possible to damage some microphones (most notably ribbon microphones) by providing phantom power.

Phase

Pressing Phase inverts the phase of the selected input. This is primarily used to correct phase problems when using multiple microphones on a single source.

EQ Module



All EQ

Pressing All EQ activates all sections of the EQ module (including the Hi and Lo Pass Filters), placing the whole module in the audio path. Toggling All EQ allows an A/B comparison of EQ'd/flat settings, without having to switch each section of the EQ individually, and without using Bypass which switches both EQ and dynamics modules in or out of the audio path. The Comp and Gate switches on individual EQ sections (see below) operate independently from the All EQ switch.

Filter In

Press Filter In to make the Hi and Lo Pass Filters active in the audio path. This selection is cancelled if Comp or Gate is pressed. Both filters provide 18dB/octave roll-off, and since the filter frequencies overlap they may be configured as a very tight bandpass filter for creative compression and gating; use when you wish to select a specific instrument or narrow frequency band from a complex signal, then feed to the sidechain of the compressor or gate.

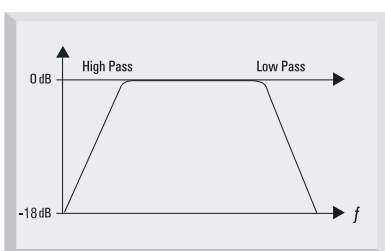

Impedance

Pressing Impedance steps through each of the four transformer pre-amp input impedance values, as indicated by their corresponding LEDs. By selecting different values for the impedance of the ISA 430 MKII transformer input, the performance of both the ISA 430 MKII pre-amp and the microphone connected can be tailored to set the desired level and frequency response.

Mic Air

Pressing Mic Air increases the impedance effect of the transformer on high frequencies. Transformers impart an effect which is often referred to as 'air', adding a spaciousness to the sound of the mic pre-amp. Mic Air further emphasises this effect. For further details see FAQ number 18 on page 22.

Low Pass Filter

Sets a roll-off frequency from 400Hz to 22kHz.

High Pass Filter

Sets a roll-off frequency from 20Hz to 16kHz.

Comp

When the Comp switch is pressed, both Hi and Lo pass filters are inserted in the compressor sidechain to enable frequency-selective (aka frequency-conscious) compression. This selection is cancelled if Filter In or Gate is pressed.

Gate

When the Gate switch is pressed both filters are inserted in the gate sidechain to enable accurate drum gating. This selection is cancelled if Filter In or Comp is pressed.

Parametric EQ

Two separate bands of parametric EQ, hi-mid and low-mid, are provided, each with continuously variable boost/cut with centre detent, sweep control with two ranges, and fully variable Q. The first band covers the range 40Hz to 400Hz (120Hz to 1k2Hz when x3 is pressed) and the second band covers 600Hz to 6kHz (1k8Hz to 18kHz when x3 is pressed).

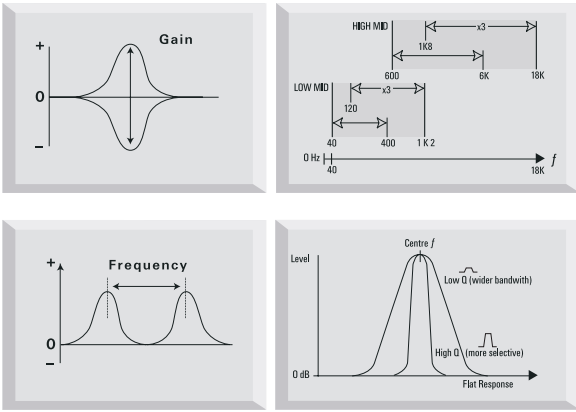

Param EQ In

Press in to switch the parametric EQ into the signal path. This selection is cancelled if Gate or Comp is pressed.

x3

The Sweep controls have two ranges, the higher being selected when the x3 switch is pressed (x3 frequencies are shown in yellow on the panel).

Comp

When the Comp switch is pressed, the parametric EQ is inserted into the compressor sidechain, allowing frequency-selective (frequency-conscious) compression. This selection is cancelled if Param EQ In or Gate is pressed.

Gate

When the Gate switch is pressed, the parametric EQ is inserted into the gate sidechain for e.g. accurate drum gating. This selection is cancelled if Param EQ In or Comp is pressed.

Shelving EQ

High and low frequency-shelving sections are available, each with continuously variable boost/cut with center detent, and a four position rotary switch for selection of roll-off frequency. In addition, the Hi Range switch allows for two ranges of roll-off frequency per band – resulting in eight frequency selections in total.

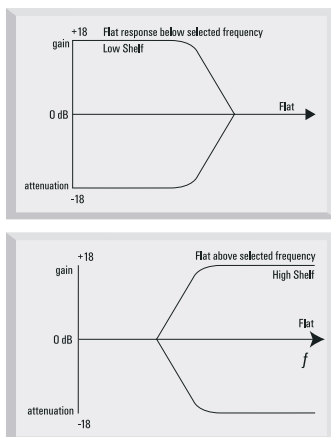

Shelving EQ In

Press in to switch the shelving EQ into the signal path. This selection is cancelled if Gate or Comp is pressed.

Hi Range

The frequency controls have two ranges, the higher being selected when the Hi Range switch is pressed (frequencies shown in yellow on the panel).

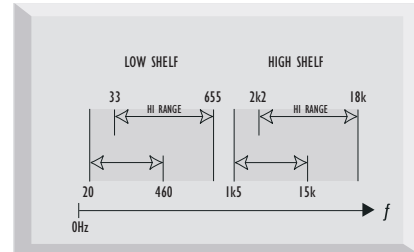

Low frequency shelving

The frequency range steps are 20Hz, 56Hz, 160Hz and 460Hz (33Hz, 95Hz, 270Hz and 655Hz when Hi Range switch is engaged).

High frequency shelving

The frequency range steps are 1.5kHz, 3.3kHz, 6.8kHz and 15kHz (2.2kHz, 4.7kHz, 10kHz and 18kHz when Hi Range is engaged).

Comp

When the Comp switch is pressed, the shelving EQ is inserted into the compressor sidechain, allowing frequency-selective (frequency-conscious) compression. This selection is cancelled if Shelving EQ In or Gate is pressed.

Gate

When the Gate switch is pressed, the shelving EQ is inserted into the gate sidechain for e.g. accurate drum gating. This selection is cancelled if Shelving EQ In or Comp is pressed.

Compressor



Comp In

Press Comp In to switch the compressor into the signal path. Note that the VU meter can be selected to display the compressor gain reduction (see Metering section, page 3).

Listen

Press to allow audio monitoring of the compressor sidechain to assist accurate frequency adjustment when setting up frequency-conscious compression. The Listen LED below the main VU meter illuminates to show that Listen mode is active. Note that the VU meter automatically displays the compressor sidechain listen level when a Listen switch is pressed in (see Metering section, page 3).

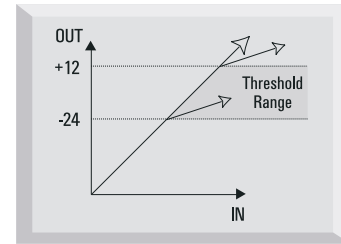

Vintage

The Vintage switch activates the vintage compressor. This has two modes, Comp and Lim, as indicated by the LEDs to the right of the Vintage switch. The Vintage switch steps through the different modes of compressor operation.

In Comp mode the compressor is a vintage opto compressor. In Lim mode the compressor acts more like a vintage opto limiter with a harder ratio and knee. When neither the Comp or Lim LEDs are illuminated the compressor is in the classic Focusrite discrete Class A VCA mode.

N.B. When in Vintage Comp or Lim mode the Attack, Release, Auto Release and Ext Key controls are inactive.

Makeup

Compression results in an overall reduction in level. The Makeup control allows you to restore the compressor's output level back to the original level.

Ratio

The Ratio control determines the rate at which compression is applied to the signal with increasing input, and is the ratio of change in input level compared to change in output level. The control gives a range of 1.5 to 10. Higher ratio settings will produce more noticeable compression, so for the least obtrusive result, the ratio should be set at the minimum necessary for the application.

For example, using low threshold and low ratio will produce a less noticeable effect than a high threshold and high ratio, even though the total amount of compression may be the same.

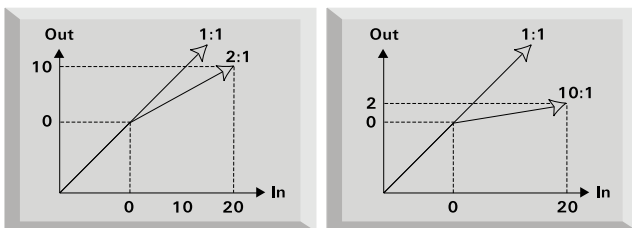

Threshold

Threshold determines the level at which compression begins, with a range of -28dB to +12dB. The lower the threshold, the more the signal is compressed. Setting a higher threshold allows quieter passages in music or speech to remain unaffected; only passages that exceed the threshold will be compressed.

Attack

Attack determines how quickly compression is applied once the level of the source signal has risen above the threshold. When turned anticlockwise the response is very fast, which tends to make the compressor react to the peak levels of the signal. This is sometimes desirable, but can cause unwanted "pumping" of steadier low level components of the signal by short transients. A slower attack will cause the compressor to ignore short transients and respond more to the average loudness of the signal; however this may seem to increase relative volume of the transients.

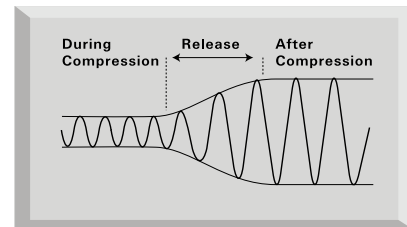
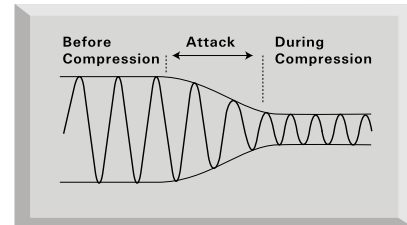

Release

Release determines how quickly compression is removed once the level of the source signal has fallen below the threshold. When in the anticlockwise position, the compression releases very quickly, which may be appropriate on rapidly varying signals to avoid compressing the beats that follow, but can result in excessive distortion on more sustained material. Clockwise rotation increases the release time, giving a smoother effect, but which at the same time may result in transients causing audible "pumping".

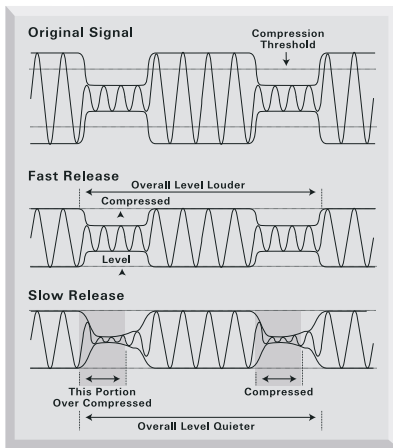

Auto Release

Press the Auto Release switch to set the release rate to auto, substituting an adaptive attack/release circuit which varies the release rate to suit the dynamics of the signal. This enables the use of fast attack times without any “pumping” type artefacts, especially effective on complex programme material. The release rate is probably the most important variable when recording rock/pop music, since it directly affects loudness. Loudness is increased by the maintenance of high mean levels: compression increases the proportion of high level signal content, and as the diagram shows, the faster the unit releases, the more low-level signal is brought to a higher level. Therefore, the faster the release rate, the higher the perceived loudness of the recording.

Ext Key

Pressing Ext Key switches control of the compressor to an external signal fed into the rear panel COMP KEY INPUT jack socket. Note that the key input is not output from the unit (it is the original input that is compressed and output) but the compression is applied as if the key input signal were being compressed. N.B. Ext Key is not available in Vintage mode.

Example: one of the problems in compressing a mixed programme is that gain reduction tends to be controlled by one dominant instrument or sound. For more natural compression, you need to attenuate the sound of the dominant instrument, but this is probably not acceptable since it would affect the mix.

Using the key input allows a second feed of the input signal to be routed through an equaliser to attenuate the dominant instrument. That signal is then fed into the key input. Now you can use the attenuated key input to control the compression of the original signal. The original signal is compressed as if the dominant instrument had been attenuated. This technique can be very useful when compressing bass-heavy dance music. By attenuating the bass in the key input signal, the bass in the original retains more of its dynamics.

Another application of this technique is to create a second de-esser. When de-essing, sibilant frequencies need to be heavily compressed. To achieve this, accentuate the sibilants

in the key input signal by adding gain to the sibilant frequencies. This will cause those frequencies to be heavily compressed in the original signal. The ISA 430 MKII's dedicated de-esser can take care of primary de-essing duties, whilst key input compression deals with a secondary problem occurring at a separate frequency.

Blend and Mix

Press the Blend switch to activate the blend circuit and make the Mix control active. The Mix control allows the user to mix a blend of uncompressed signal and compressed signal (from totally uncompressed to fully compressed). Equal amounts of compressed and uncompressed signal are present when the mix control is set to its mid point.

N.B. When attempting to use the compressor blend and the gate simultaneously, the gate will be less effective. This is because the original input signal and the processed (gated) signal are being blended, so the more input signal there is, the less audible the effect of the gate will be.

Gate



Gate In

Press Gate In to switch the gate into the signal path.

Expand

Pressing Expand causes the gate to function as an expander, which has a similar effect to gating, but instead of cutting off any signal below the threshold, it proportionately decreases it (see diagram below). This may give a more natural sound when recording non-percussive sources. Pressing Expand a second time causes the switch to revert to being unlit, and causes the section to act as a gate once more. The adjacent LED meter indicates in dB the amount of gain reduction applied by the expander/gate, and provides additional visual indication of the effect of the Range control (see below).

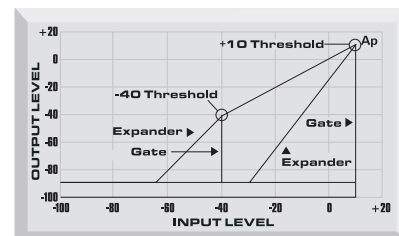

Listen

Press to allow audio monitoring of the gate sidechain to enable accurate frequency adjustment during setup. The Listen LED below the main VU meter illuminates to show that Listen mode is active. Note that the VU meter

automatically displays the gate sidechain listen level when a Listen switch is pressed in (see Metering section, page 3).

Range

Range determines how much the signal is attenuated when the gate is closed. The gate can be set up to cut (80dB attenuation, control clockwise) or to more gently lessen attenuation (min 0dB). Maximum attenuation may give an unnatural sound, so keep Range at a low value unless it is essential to reduce high levels of background noise, or unless an obviously gated effect is desired.

Threshold

Threshold determines the level at which the gate opens (or at which gain reduction finishes when in Expander mode). The higher the threshold, the more low-level noise is reduced, and the more extreme the effect.

Hold

Hold controls the variable delay before the gate release starts. This allows the gate to be held open until the signal has decayed sufficiently, so that the rapid onset of gain reduction isn't noticeable. Alternatively the signal can be deliberately truncated before its natural end to create a special effect.

Release

This control sets the Release time, the rate at which the gate attenuation increases, fading out the signal. This release period begins as soon as the signal drops below the threshold. On transient signals, a fast release will be appropriate (control anticlockwise), but with other material, a slower release (control clockwise) may give a more natural sound. Ideally the release needs to be slightly slower than the natural decay rate of the signal to avoid audibly cutting it short.

Fast Attack

Fast Attack determines how quickly the gate opens once the level of the source signal has risen above the threshold. When the switch is pressed, the response is fast, which may be necessary on some signals to avoid "missing" an initial transient, but which could also introduce an undesirable click on smooth, sustained sounds when using a high threshold setting. On such signals a slower attack (switch released) may give a more natural sound.

Hyst

Press to introduce wider hysteresis. This increases the level difference between the gate switching on and off, which prevents the gate from oscillating ('chattering') with particular combinations of input signal and threshold setting. This function is particularly useful when gating a signal with a very long decay time and large amounts of level modulation (e.g. a grand piano).

Ext Key

Pressing Ext Key switches control of the gate to an external signal on the rear panel GATE KEY INPUT jack.

De-Esser



The de-esser uses an optical design, allowing the user to remove excessive sibilance from a vocal performance (where "ess" sounds are over-emphasised).

De-Ess In

Press in to activate the De-Esser.

Threshold

Threshold determines how much de-essing is being applied to the selected frequency. The lower the threshold (control anticlockwise) the more de-essing is applied.

Freq

This control selects the frequency to be removed; between 2k2Hz and 9k2Hz.

De-Ess Listen

Press to allow monitoring of only those signals which will trigger activation of the de-esser, rather than hearing the overall effect in a complex full bandwidth signal. The Listen LED below the main VU meter illuminates to show that 'Listen' mode is active. Note that the VU meter automatically displays the de-ess listen level when the Listen switch is pressed in (see Metering section, page 3).

Active LED

The Active LED illuminates when the de-esser is active at the chosen frequency, and shines more brightly with increasing level reduction.

Setting up the De-Esser

Press De-Ess Listen with Threshold at maximum and slowly reduce until the selected frequency begins to trigger the de-esser. Vary the frequency control to find the exact area of the signal which you wish to remove. Once located, switch off De-Ess Listen and adjust Threshold for the amount of reduction required. No further adjustment of Freq should be required, as the hot spot will have been precisely found using De-Ess Listen.

Output



Ext Sum

Press to route a sum of both the internal signal and external line input signal (from the EXT SUM INPUT) to the Main Output. External signals could

be a double track, an extra mic from a second ISA 430 MKII, or live reverb.

Ext Level

This control adjusts the gain of the external line input which may be summed into the Main Output (see above).

Output

Adjusts the Main Output level between -60dB and +6dB.

Mute

Press to mute the output of both the Main Output and Post-Mic Output. N.B. Analogue sends and digital outputs are not muted.

Bypass

All EQ and dynamics processing modules can be globally switched out using the Bypass switch, for quick A/B comparison of processed/unprocessed signals.

Inserts and Routing Matrix

The ISA 430 MKII has two insert points and a very comprehensive set of routing options.

Insert 1



Activated by the Insert 1 In switch. The insert 1 send and return are both balanced XLRs and are situated post- the Phase switch. Insert 1 Send and Return always remain pre- any of the processing sections (EQ, dynamics etc).

Using Insert 1 as 'traditional' insert:

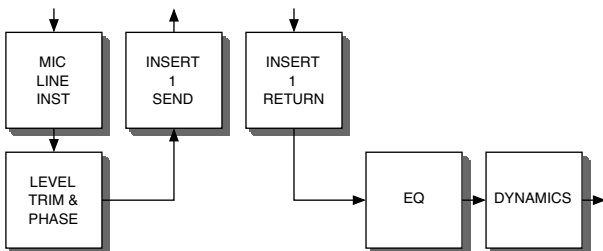

EQ Split

Activated by the EQ Split switch. This allows the INSERT SEND 1 and INSERT RETURN 1 connections to act as inputs and outputs to the EQ section only, thus giving a separate line level EQ unit, which acts independently from the dynamics processing. When EQ Split is selected, the Insert 1 switch, if lit, will go out. This is because Insert 1 is now being used as the input and output to the EQ section, and so is no longer available for use as a 'traditional' insert.

Using Insert 1 to split EQ:

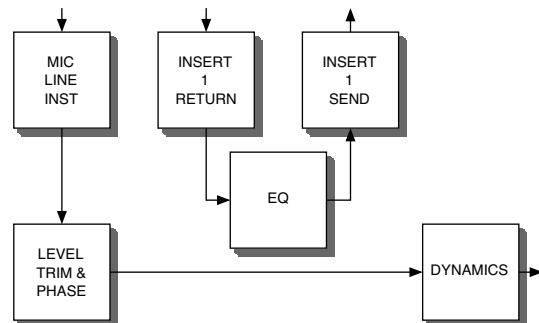

Dynamics Split

Activated by the Dyn Split switch. This allows the INSERT SEND 2 and INSERT RETURN 2 connections to act as independent inputs and outputs to the dynamics section only, thus giving a separate line level dynamics unit. When Dyn Split is selected, the Insert 2 and Post-Dyn switches, if lit, will go out. This is because Insert 2 is now being used as the input and output to the dynamics section, and so is no longer available for use as a 'traditional' insert.

Using Insert 2 to split dynamics:

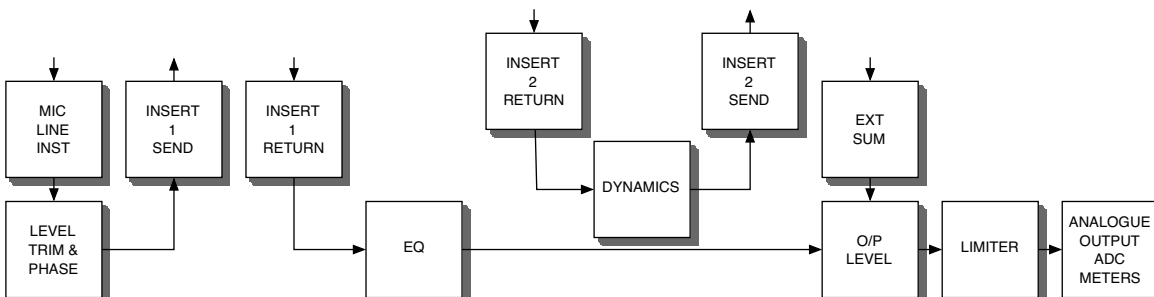

Dynamics position switch

Allows the dynamics section to be placed in three different positions in the processing chain. (Normally the dynamics section is the second processing section in the signal path, after the EQ section.) When activated, the new position of the dynamics section is indicated by the LEDs below the Dynamics switch.



a) Dynamics Post-EQ (Default)

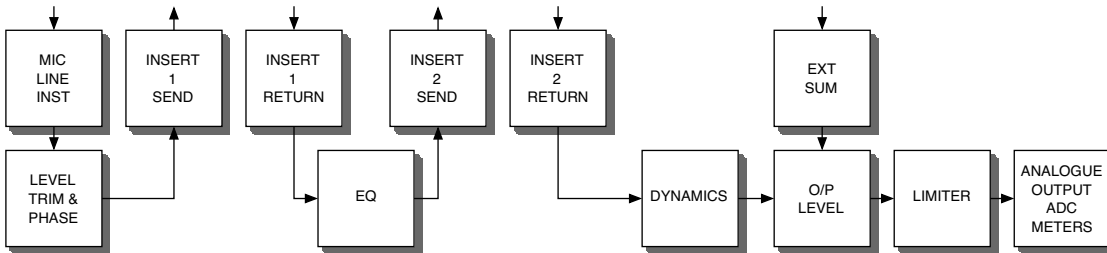

b) Dynamics Pre-EQ

Pressing Dynamics once reverses the position of the EQ and dynamics sections, placing dynamics first and EQ afterwards. The Pre-EQ LED illuminates to provide visual confirmation of the dynamics' pre-EQ position.

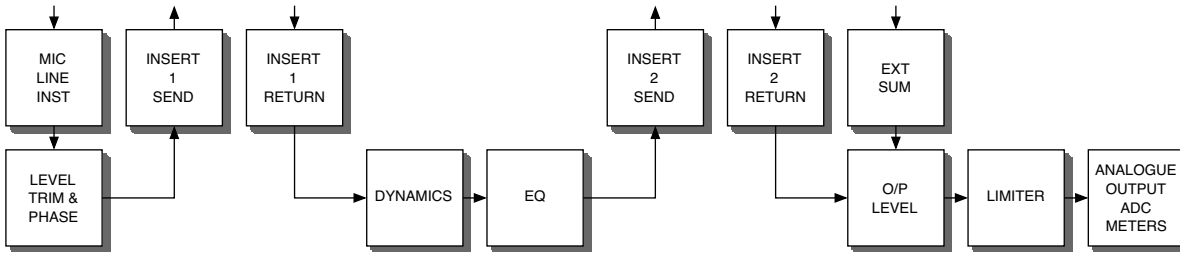

c) Dynamics Post-Sum

Pressing Dynamics a second time places the dynamics section after the Ext Sum, Ext Level and Output faders but before the limiter. The Post-Sum LED illuminates to provide visual confirmation of the dynamics' POST-SUM position. This allows the external signal, which has been summed to the main input signal, to be processed through the dynamics section of the ISA 430 MKII. Pressing Dynamics a third time returns the dynamics section to its default position (post-EQ, pre-Sum) where both the Pre-EQ and Post-Sum LEDs are unlit.

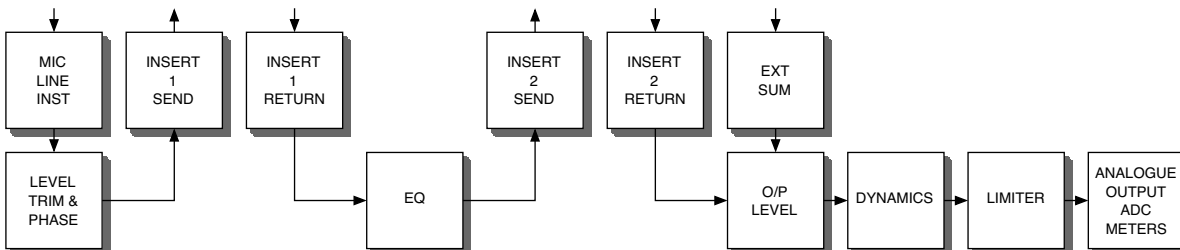

Insert 2



Activated by the Insert 2 In switch. The insert 2 send and return are both balanced XLRs and can be placed in four different positions in the signal path dependant upon the relative positions of the Post-Dyn and Dyn Split switches. (N.B. It is not possible to have the following combination of switches for Insert 2: Insert 2 In + Post-Dyn + Dynamics Post-Sum.)

a) Insert 2 In

Insert 2 placed post-EQ and pre-dynamics.

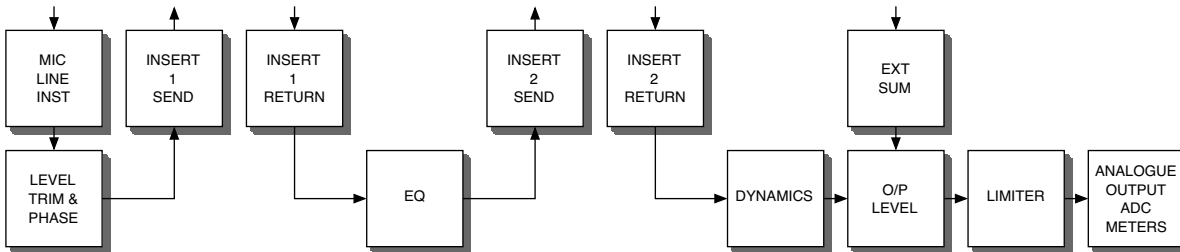

b) Insert 2 In + Post-Dyn

Insert 2 placed post-dynamics and post-EQ

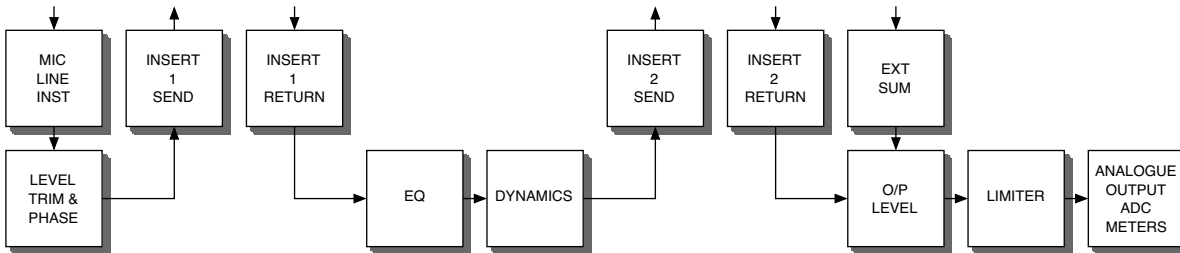

c) Insert 2 In + Dynamics Post-Sum

Insert 2 placed post-EQ and pre-sum/pre-dynamics (dynamics have moved post-sum).

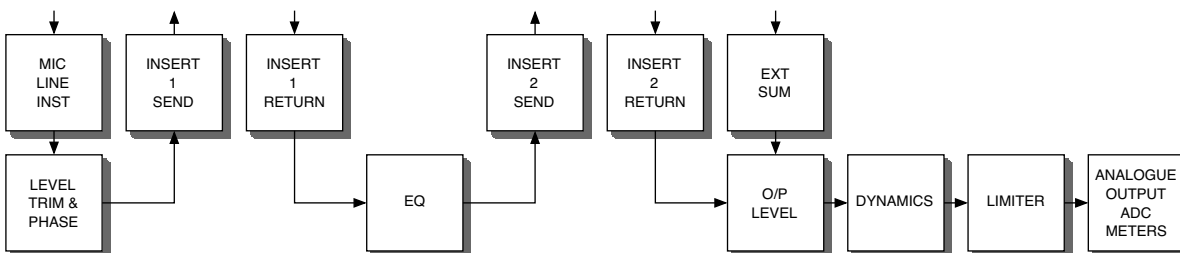

d) Insert 2 In, Post-Dyn + Dynamics Pre-EQ

Insert 2 placed post-dynamics and pre-EQ.

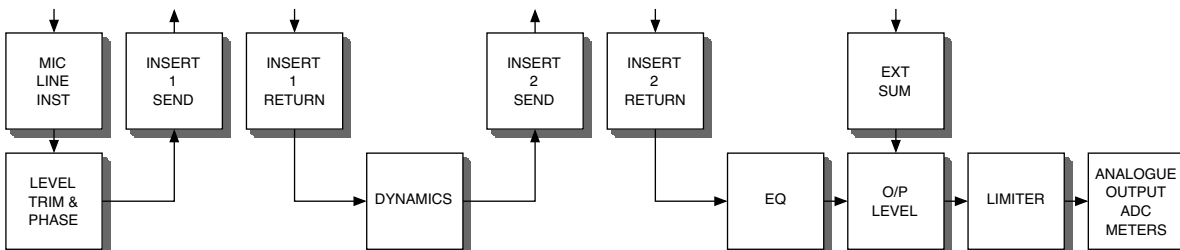

(Examples a-d show Insert 2 being used as a 'traditional' insert.)

Soft Limiter

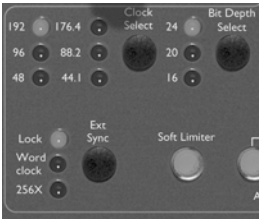

Press to activate the soft limiter. The soft limiter circuit acts by gradually increasing the ratio of the limiter as the signal exceeds the threshold. The threshold is set at -6dBFS ($+16\text{dBu}$). Signal levels between -6dBFS and -4dBFS have a ratio of 1.5:1

applied to them, signal levels between -4dBFS and 0dBFS have a ratio of 2:1 applied to them, and signal levels between 0dBFS and $+6\text{dBFS}$ have a ratio of infinite:1 applied to them.

The attack and release times for the limiter are instantaneous. This means that the audio is “clamped down” so that the signal can never go above the maximum level that the ADC can accurately convert (0dBFS). Consequently, it is impossible to overload the connected optional ADC card when the soft limiter is active.

Optional Analogue to Digital Converter (ADC)



The ISA 430 MKII can be used as a high quality two-channel ADC to convert analogue signals to the digital domain, by adding the optional ISA 430 MKII digital output board. The two external ADC inputs and the main channel inputs can all be fed to the ADC, via the soft limiter, ensuring super-clean, protected, high-quality digital conversion. Alternatively, two ISA 430 MKII units with a single A/D option can be used to create a stereo tracking/mixdown to digital system (see ‘Stereo ISA 430 MKII Units’ on page 20).

Digital formats available on the ADC are AES, SPDIF (optical and coaxial RCA phono) and ADAT™ optical format. (The ADAT™ outputs can also operate in high speed SMUX mode for 96kHz transfer speeds, but are muted during 192kHz operation.) N.B. If RCA phono (SPDIF) or XLR (AES) connections are required, the relevant 9-pin D-type to RCA phono or XLR breakout cable is required. For installation details, see separate A/D option user guide.

ADC Input 1 and 2

With the **ADC Input 1 and 2 switches both unlit**, whatever is connected to the mic, line or instrument input feeds the main analogue output, and also feeds the left side of the A/D converter. Both signals are post-processing. A pre-processed signal is fed to the post-mic output, and this pre-processed signal is also fed to the right side of the A/D converter.

With the **ADC Input 1 switch lit and ADC Input 2 switch unlit**, whatever is connected to ADC input 1 cuts

whatever is connected to the mic, line or instrument input, and feeds the left side of the A/D converter in its place. The pre-processed signal is still fed to the post-mic output, and this is still also fed to the right side of the A/D converter.

With the **ADC Input 1 switch unlit and ADC Input 2 switch lit**, whatever is connected to the mic, line or instrument input feeds the main analogue output, and feeds the left side of the A/D converter. Both signals are post-processing. Whatever is connected to ADC input 2 cuts the unprocessed signal fed from the mic, line or instrument input, and feeds the right side of the A/D converter in its place.

With **ADC Input 1 and 2 switches both lit**, whatever is connected to ADC input 1 cuts whatever is connected to the mic, line or instrument input, and feeds the left side of the A/D converter in its place. Whatever is connected to ADC input 2 cuts the unprocessed signal fed from the mic, line or instrument input, and feeds the right side of the A/D converter in its place. See ADC Configurations diagrams on page 15.

24-bit/96kHz ADAT™ (optical/lightpipe) interface operation

The card provides digital outputs for both ISA 430 MKII ADC input channels, which operate over the sample frequency ranges 44.1, 48, 88.2 and 96kHz, and can be dithered to 16-, 20-, or 24-bit depths depending upon the destination. The card features an ADAT™-type ‘lightpipe’ output and SPDIF Toslink output connectors. ADAT™ lightpipe cables are available from your local dealer, or in the UK from Studiospares (tel +44 (0)20 7482 1692): stock number 585-510.

24-bit/192kHz AES/SPDIF operation

The card also provides AES and SPDIF format outputs via a 9-pin D-type connector on the rear panel. The full range of sample rates (up to 192kHz) and bit depths are available. To access the digital signals from the 9-pin D-type output connector, the A/D card must be purchased with either an AES or SPDIF D-type conversion cable as follows:

AES cable: 9-pin D-type to 4 male XLR

SPDIF cable: 9-pin D-type to 4 male RCA phono

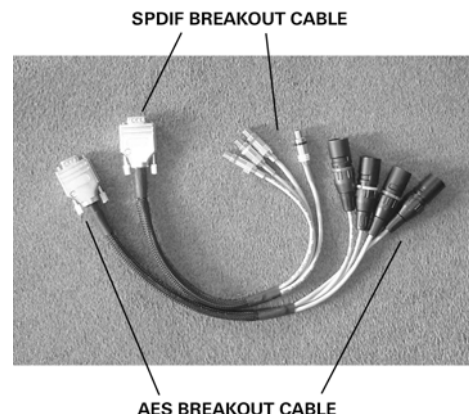

Note: cables need to be purchased separately. Since there are two different cable options – XLR for AES and RCA phono for SPDIF – these are not included with the A/D converter options. Focusrite cables may be purchased from your local dealer. If you experience difficulty in obtaining these cables, contact your local distributor as listed in the back of this manual.

AES/SPDIF Connector Configuration

The 9-pin D-type connector labeled AES/SPDIF can be configured either as an AES or SPDIF dedicated output using the AES/SPDIF switch next to it. When operating the connector in AES mode an AES cable is required. When operating in SPDIF mode the SPDIF RCA cable should be used, which automatically sets the output stream to consumer mode.

The 1 Wire/2 Wire switch selects 1 wire or 2 wire mode for the AES output as follows:

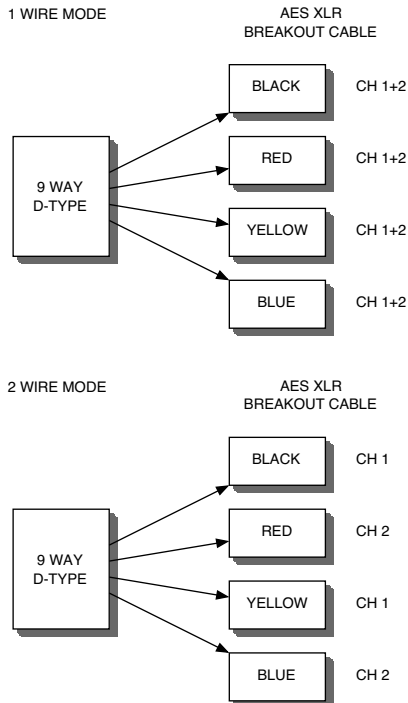

1 Wire mode

Selected with the switch in the 'out' position. The AES connector transmits two channels of AES data simultaneously for all sample frequencies from 44.1 to 192kHz, over a single wire.

2 Wire mode

Selected with the switch in the 'in' position. The AES connector transmits one channel of AES data only per cable, for all sample frequencies from 96kHz to 192kHz. The reason for the two modes is that older equipment with 96kHz and 192kHz AES inputs can only receive speeds up to 192kHz by using both digital channels of a single AES connection (known as '2 wire'). Therefore one AES channel can send only a single channel of digital data. This switch

makes the ISA 430 MKII useable with both old and new equipment.

Word Clock In and Out

The internal ADC can be synchronised to an external word clock. By pressing the front panel Ext Sync switch, the ISA 430 MKII can be switched to lock to either standard external word clock or 256X external word clock.

Either type of external word clock should be connected to the ISA 430 MKII ADC card at the WORD CLOCK IN BNC connector. The WORD CLOCK OUT BNC connector either regenerates the external word clock connected at the word clock input connector (if locked to an external clock source) or transmits the internal sample frequency of the ADC card (if the ISA 430 MKII is acting as word clock master).

Where the ISA 430 MKII is being used as a slave device within a larger digital system, the WORD CLOCK OUT BNC connector can be used to pass on the external word clock signal to the next device. When the unit is not slaved to another device and is in internal clock mode, the word clock output connector outputs the sample frequency selected on the ISA 430 MKII front panel.

Digital Output Front Panel Controls

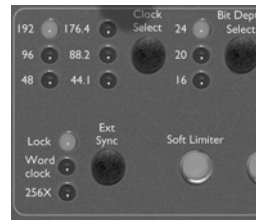

Clock Select

Pressing this switch allows the user to select between sample frequencies of 44.1kHz, 48kHz, 88.2kHz, 96kHz, 176.4kHz, and 192kHz.

Bit Depth Select

Pressing this switch allows the user to select between 24-, 20- and 16-bit depths.

Ext Sync

Pressing Ext Sync allows the ISA 430 MKII to be slaved to an external word clock source. Selecting 256X allows the ISA 430 MKII to be slaved to an external clock running at 256 times faster than the sample frequency and enables connection to systems such as the Digidesign 'Superclock' or other 256 slave clock devices.

Lock LED

When lit, LOCK indicates that the unit is synchronised to an external clock source.

ADC Configurations

Analogue recording with digital conversion

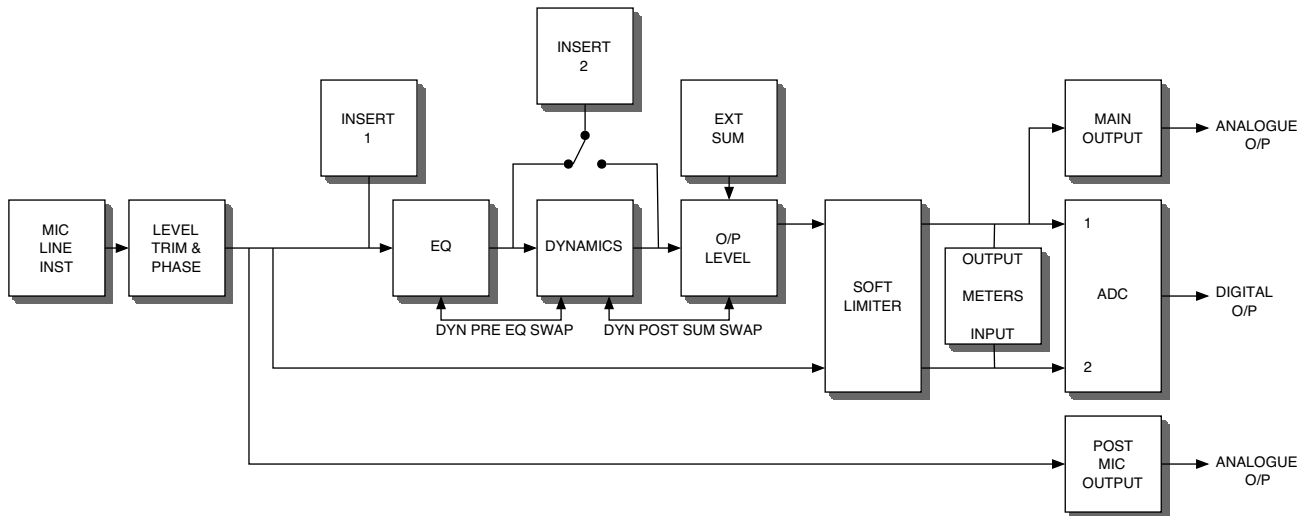

(In this example both ADC 1 and ADC 2 switches are unlit and Soft Limiter is switched in.)

Analogue recording and stand-alone stereo ADC conversion

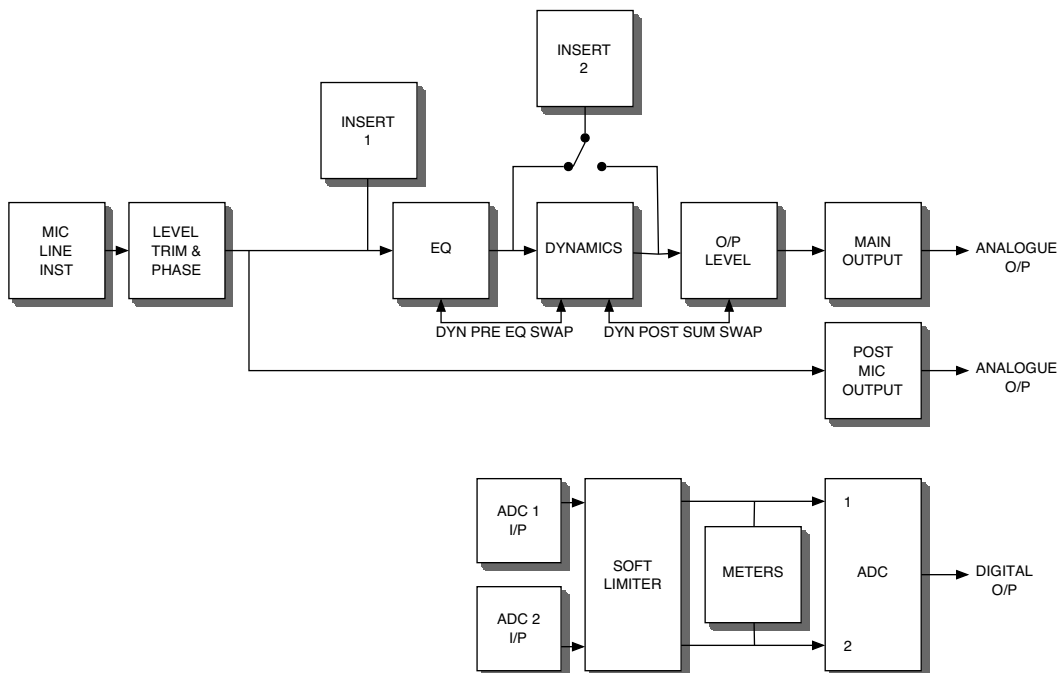

(In this example both ADC 1 and ADC 2 switches are lit and Soft Limiter is switched in.)

Mic Pre-amp Input Impedance

A major element of the sound of a mic pre-amp is related to the interaction between the specific microphone being used, and the type of mic pre-amp interface technology to which it is connected. The main area in which this interaction has an effect is the level and frequency response of the microphone, as follows:

- **Level:** Professional microphones tend to have low output impedances, so more level can be achieved by selecting the higher impedance positions of the ISA 430 MKII mic pre-amp.
- **Frequency response:** Microphones with defined presence peaks and tailored frequency responses can be further enhanced by choosing lower impedance settings. Choosing higher input impedance values will tend to emphasise the high frequency response of the microphone connected, allowing improved ambient information and high end clarity, even from average-performance microphones.

Various microphone/ISA 430 MKII pre-amp impedance combinations can be tried to achieve the desired amount of colouration for the instrument or voice being recorded.

To understand how to use the impedance selection creatively it may be useful to read the following section on how the microphone output impedance and the mic pre-amp input impedance interact.

Switchable Impedance: In Depth Explanation

Dynamic moving coil and condenser mics

Almost all professional dynamic and condenser microphones are designed to have a relatively low nominal output impedance of between 150Ω and 300Ω when measured at 1kHz. Microphones are designed to have such low output impedances because the following advantages apply:

- They are less susceptible to noise pickup.
- They can drive long cables without high frequency roll-off due to cable capacitance.

The side-effect of having such low output impedance is that the mic pre-amp input impedance has a major effect on the output level of the microphone. Low pre-amp impedance loads down the microphone output voltage, and emphasises any frequency-related variation in microphone output impedance. Matching the mic pre-amp resistance to the microphone output impedance, (e.g. making a pre-amp input impedance 200Ω to match a 200Ω microphone) still reduces the microphone output and signal to noise ratio by 6dB, which is undesirable.

To minimise microphone loading, and to maximise signal to noise ratio, pre-amps have traditionally been designed to have an input impedance about ten times greater than the

average microphone, around $1.2k\Omega$ to $2k\Omega$. (The original ISA 110 pre-amp design followed this convention and has an input impedance of $1.4k\Omega$ at 1kHz.)

Input impedance settings greater than $2k\Omega$ tend to make the frequency-related variations of microphone output less significant than at low impedance settings. Therefore high input impedance settings yield a microphone performance that is more flat in the low and mid frequency areas and boosted in the high frequency area when compared to low impedance settings.

Ribbon microphones

The impedance of a ribbon microphone is worthy of special mention, as this type of microphone is affected enormously by pre-amp impedance. The ribbon impedance within this type of microphone is incredibly low, around 0.2Ω , and requires an output transformer to convert the extremely low voltage it can generate into a signal capable of being amplified by a pre-amp. The ribbon microphone output transformer requires a ratio of around 1:30 (primary: secondary) to increase the ribbon voltage to a useful level, and this transformer ratio also has the effect of increasing the output impedance of the mic to around 200Ω at 1kHz.

This transformer impedance, however, is very dependent upon frequency - it can almost double at some frequencies (known as the resonance point) and tends to roll off to very small values at low and high frequencies. Therefore, as with the dynamic and condenser microphones, the mic pre-amp input impedance has a massive effect on the signal levels and frequency response of the ribbon microphone output transformer, and thus the 'sound quality' of the microphone. It is recommended that a mic pre-amp connected to ribbon microphone should have an input impedance of at least 5 times the nominal microphone impedance.

For a ribbon microphone impedance of 30Ω to 120Ω the ISA 430 MKII's input impedance of 600Ω (Low) will work well, and for 120Ω to 200Ω ribbon microphones the input impedance setting of $1.4k\Omega$ (ISA 110) is recommended.

Impedance Setting Quick Guide

High mic pre-amp impedance settings

- Will generate more overall level
- Will tend to make low- and mid-frequency response of the microphone flatter
- Will improve high-frequency response of the microphone.

Low pre-amp impedance settings

- Will reduce the microphone output level
- Will tend to emphasise the low- and mid-frequency presence peaks and resonant points of the microphone

Applications

Super clean recording

This example shows the shortest possible (lowest distortion) analogue signal path from mic to tape. It bypasses all EQ and dynamics functions.

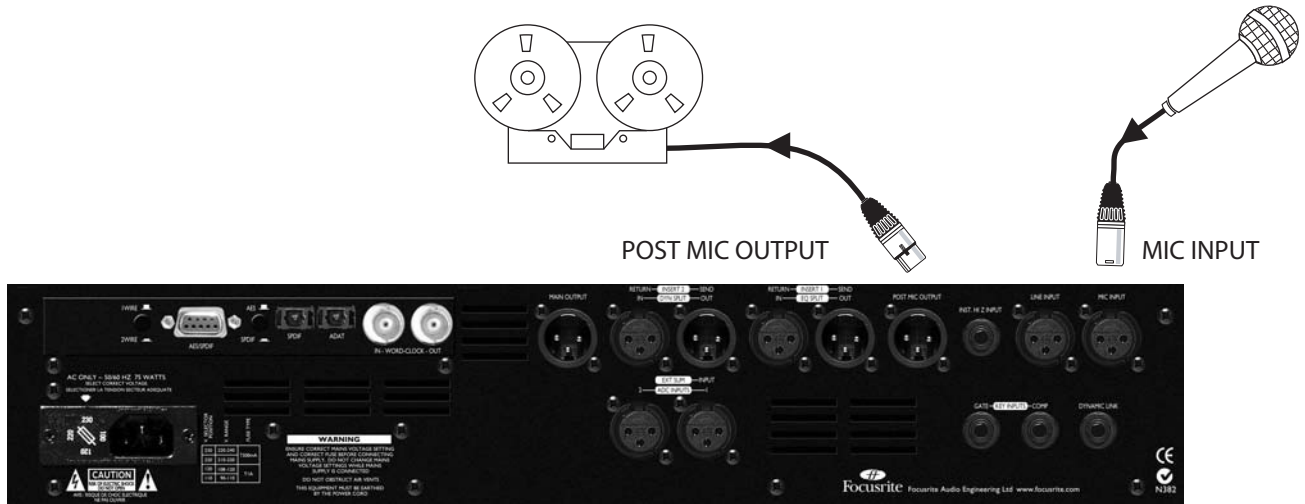

Record channel

This example shows the ISA 430 MKII being used for mic or guitar recording. The insert points may be used to add external processing 'in-line' if required.

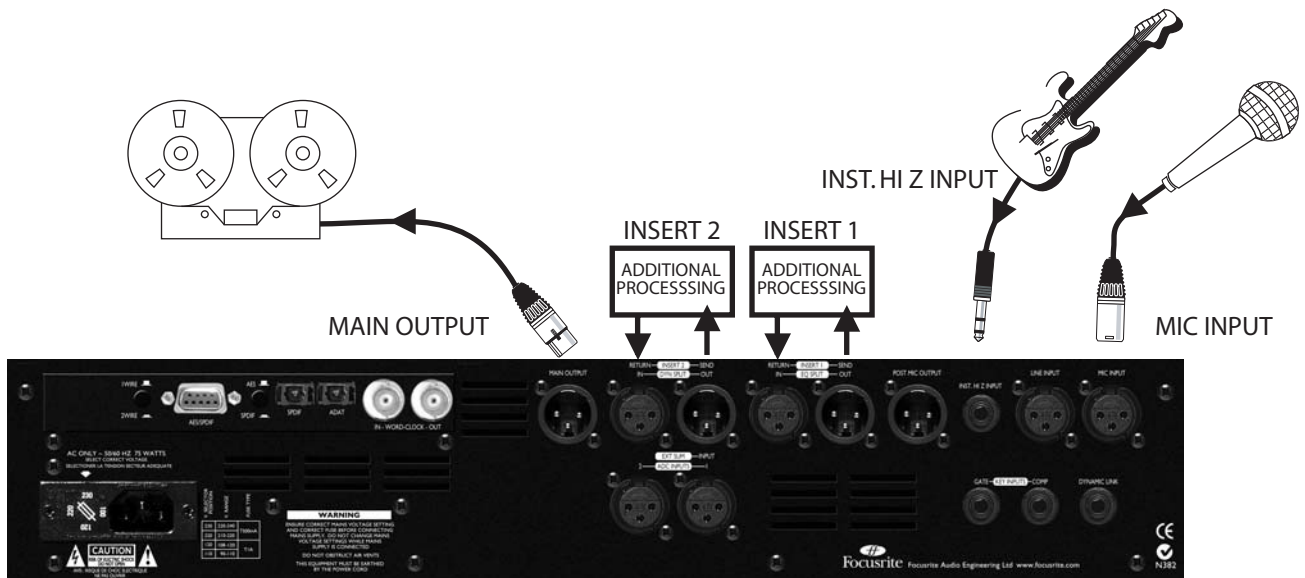

Stereo ADC

The optional ADC card is a stereo device that can convert two tracks simultaneously. Routing to the ADC card can be done from the main internal signal (fed by the mic, line and inst. inputs). External signals can also be routed directly from the ADC Inputs 1 & 2 on the rear panel, via the soft limiter. The digital meters automatically switch to monitor an ADC input when either one is selected. N.B. Input 1 of the ADC routes into the ISA 430 MKII at the same point as the main audio output. Input 2 of the ADC routes to the same point as the post-mic output. (Requires optional ISA 430 MKII digital output board.)



Split + digital record mode

This example shows an analogue input connected to Insert Return 1, and then routed, via the EQ modules, to Insert Send 1, which then feeds ADC Input 1. A second analogue input is connected to Insert Return 2, and then routed, via the dynamics module, to Insert Send 2, which then feeds the ADC Input 2. This allows two separate sources to be processed and recorded via the digital output. (Requires optional ISA 430 MKII digital output board.)

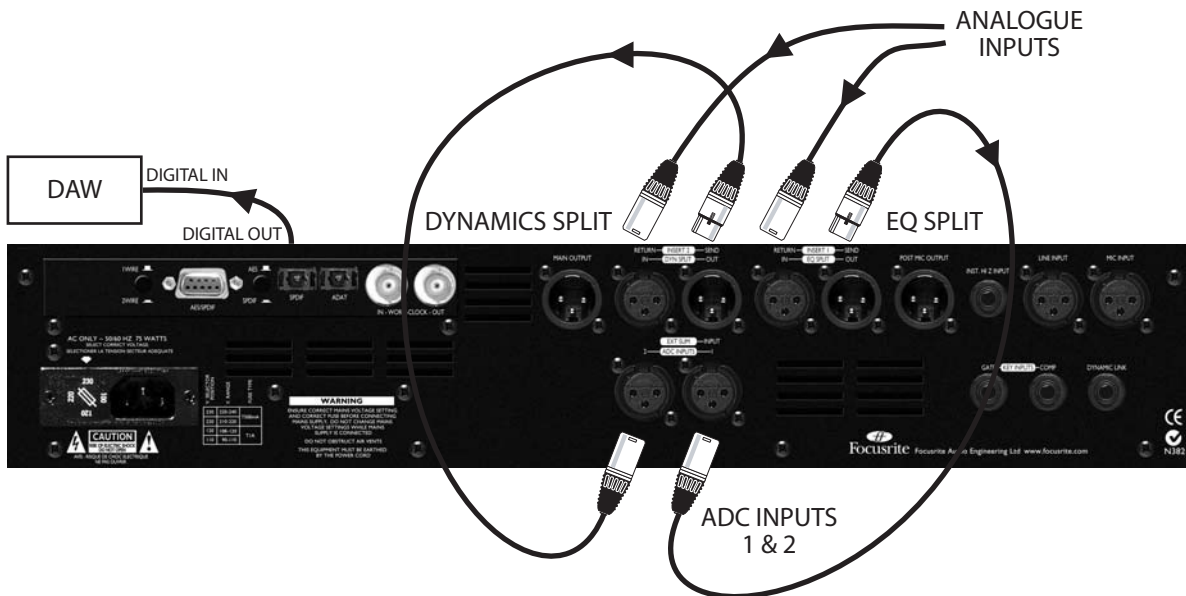

Split 'mixdown mode'

This example shows how to use the ISA 430 MKII in split mode as a mixdown tool. The unit has been switched to both EQ Split AND Dyn Split, and connected to two channel inserts of a mixing console. One is used to EQ, the other as a dynamics processor. The stereo mix is then converted using the ISA 430 MKII's ADC and soft limiter for high quality digital mastering. The ISA 430 MKII is simultaneously allowing EQ processing (channel 1) and dynamics processing (channel 2) of audio from the console, AND allowing independent ADC digital conversion of the final stereo mix fed from the master L/R console outputs. (Requires optional ISA 430 MKII digital output board.)

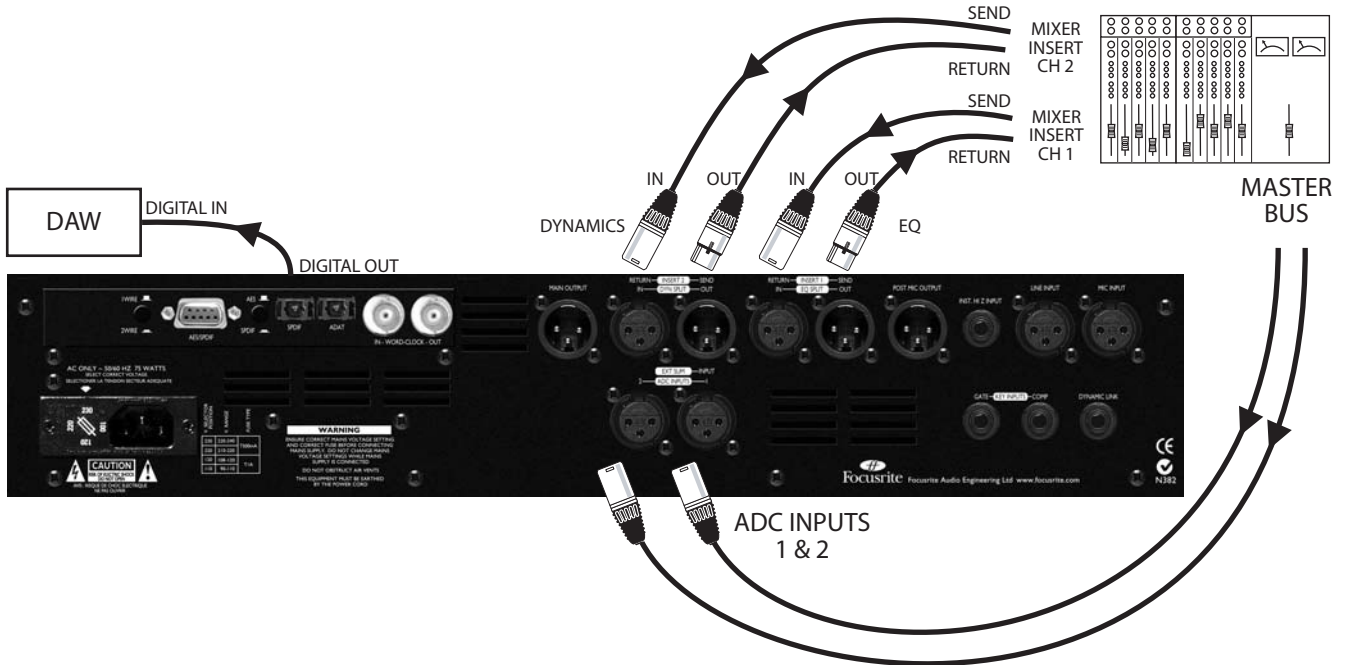

Stereo ISA 430 MKII units + stereo digital conversion

This example shows audio being sent from one ISA 430 MKII to an ADC card installed in a second ISA 430 MKII. This configuration creates a stereo record channel with only one ADC card required. The ADC Input 2 switch has been selected on the unit B's front panel, routing the external signal from unit A into the ADC. The dynamics sections of the two units have been linked by connecting a cable between the DYNAMIC LINK sockets, allowing stereo dynamics processing and dual mono EQ.

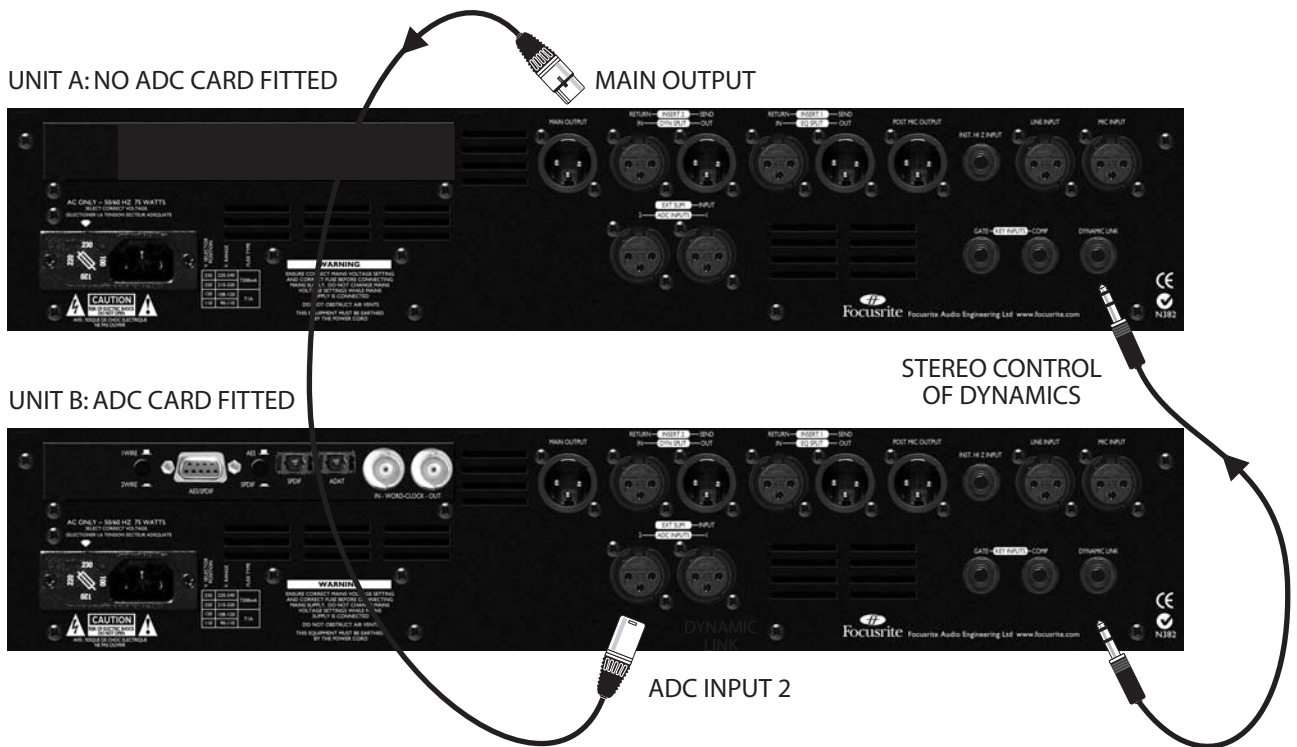

Using the ISA 430 MKII as four discrete units

This example shows how to use the ISA 430 MKII as four individual processing units. This unit is switched to EQ Split AND Dyn Split, and ADC Inputs 1 & 2 are switched on. The unit is simultaneously allowing EQ processing of audio, plus separate dynamics processing of audio. At the same time it is allowing two channels of A/D conversion into a DAW as well as allowing super clean microphone recording! (Requires optional ISA 430 MKII digital output board.)

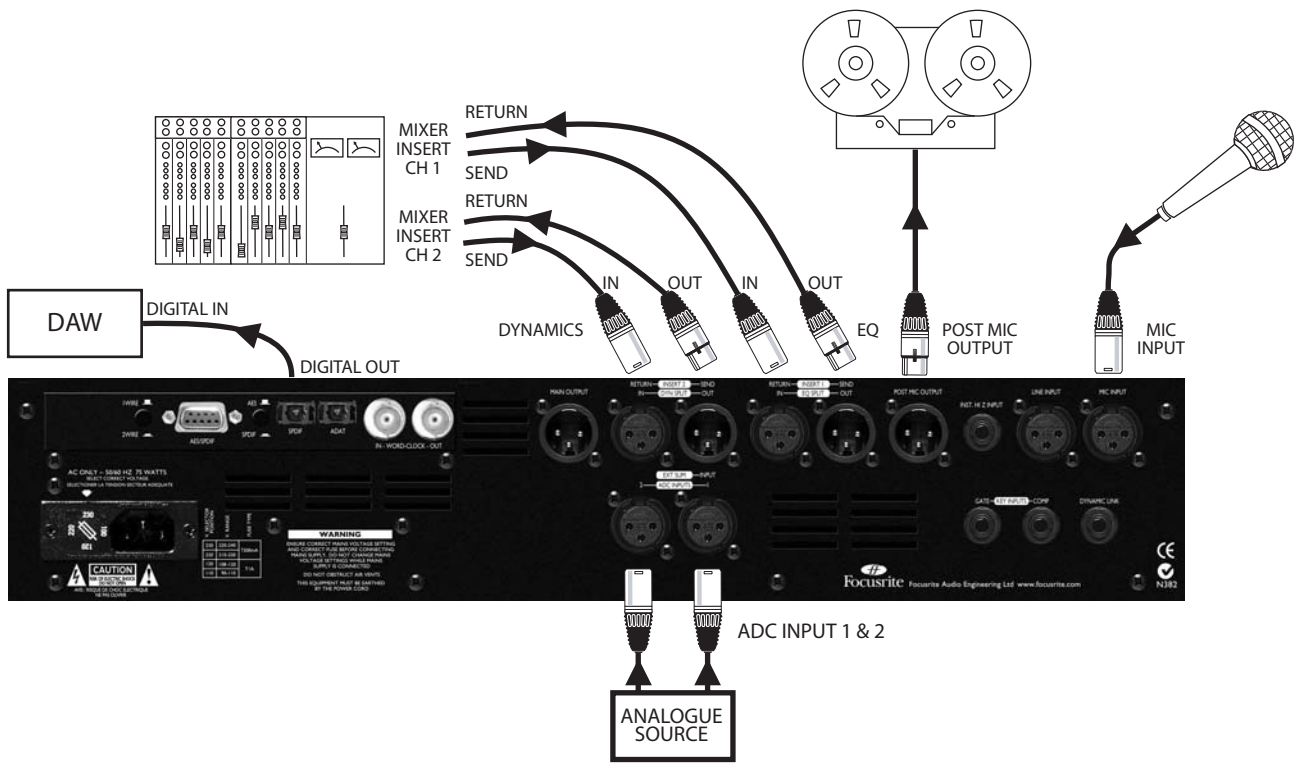

Using Ext Sum to record a single source with two mics

This example shows an analogue output from Focusrite's ISA 428 mic pre-amp routed into the EXT SUM Input on the ISA 430 MKII. The EXT SUM switch is on and the signals' levels are being balanced using the Ext Level control. The Dynamics switch has been pressed to select Post-Sum. This shows how to record a single source such as a snare drum with two microphones, summing the signals together and then processing with the dynamics section.

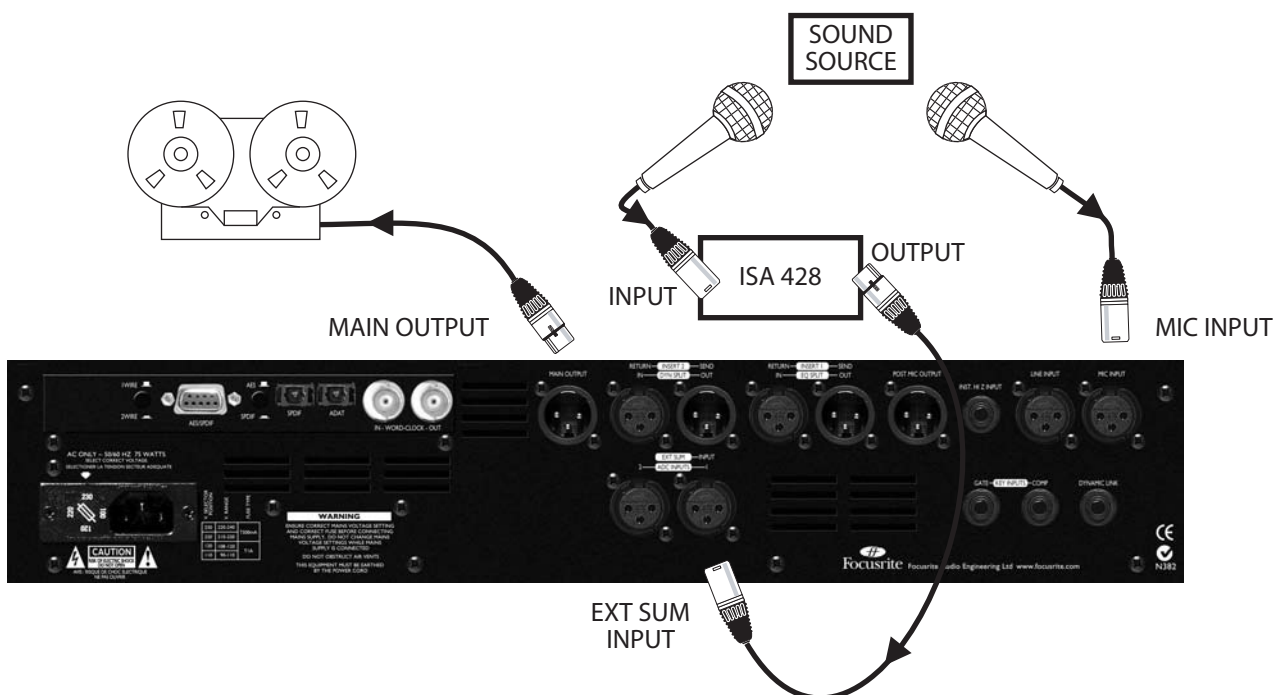

FAQs

1. Are the EQ and Dynamics the original Focusrite designs?

Yes; the mic pre-amp, hi- and lo-pass filters, EQ, compressor, and expander/gate are all based on those used in the original Focusrite console. However, the circuitry has been expanded to incorporate new features; the ISA 110 EQ having additional frequency options for its shelving and the compressor now including opto-circuitry and extra routing and controls. Plus, the mic pre-amp has a variable impedance and new selectable 'air' effect.

2. Is the ISA 430 MKII a Class A device, and why is that important?

Yes, the 430 MKII is a Class A device. Why? Well, Class A is a type of amplifier design in which you have a standing DC current running through your amplifier circuits all the time. As the signal comes along you vary what you're taking from that, rather than switching between supplying a positive current for one half of the waveform and a negative current for the other half. This results in the ability to represent audio in a linear (distortion free) manner all the way through the circuit. Cheaper processors use IC amplifiers which run close to Class B and don't have the same standing DC current, which means the transistors inside the chips switching off and on, inevitably resulting in less linear performance.

3. What does the 'Vintage' compressor button involve?

In addition to the Class A VCA circuit, the vintage optical circuit adds a whole new flavour of compression. The vintage circuit operates in two modes, as a compressor character or as a limiter. The attack and release are fixed when using the opto-circuit and the threshold point is raised/the knee hardened when compressing with the limiting characteristics selected.

4. So the compressor contains both VCAs and optical technology?

Yes. Whilst the expander and gate use solely VCAs and the de-esser and limiter are optical.

5. I've heard of the 'pumping' effect that sometimes occurs when a signal is compressed. How can it be avoided?

If the release time is too short, the signal level may 'pump' - in other words, you can hear the level of the signal going up and down. However, a release time that is too long will result in the level of quiet sounds following a loud beat to be reduced even further. In addition, having the threshold set below the level of the kick drum and the release time set relatively long will punch holes in the track as the level drops with each beat. If the release time is adjusted to be much faster than an entirely different, dynamic-sounding mix can be produced. As a rule, a good starting point for release time lies between 0.2 and 0.6 seconds.

6. What can the inserts do?

Both inserts are "split-configurable". This means that insert 1 can split the EQ from the signal path if the option is

selected and insert 2 can split the dynamics. Also, insert 2 is flexible as to signal positioning and defaults to pre-dynamics but can move to post- if desired.

7. What if I want my dynamics processing to occur pre-EQ or post-sum?

No problem; the dynamics section can be switched so that it precedes the EQ section by a single push of the Pre-EQ button on the front panel. Pressing the Post Sum button places the dynamics section after the Ext Sum input. See Inserts and Routing Matrix on page 10 for more details.

8. Is there any way to configure the ISA 430 MKII as a stereo unit?

Yes; although a single ISA 430 MKII can act only as a mono or split mono unit, it's possible to link two MKIIs together, using the 'dynamic link' socket on the rear panel. Using a single stereo TRS jack cable, this allows stereo operation of the compressor, plus dual mono EQ. You can also use a single ISA 430 MKII as a stereo A/D converter. See question 16 below for a full explanation.

9. How do I control which ISA 430 MKII will be the controller and which will be the slave when using two together for stereo compression?

Whichever ISA 430 MKII is generating the greater control voltage will be the controller. So, set one of the MKII's compressors to minimum ratio and maximum threshold, and the other compressor will then always be the 'controller,' with any changes made on the controller knobs affecting both channels in the same way.

10. Can I wire the link cable to just link the compressors or gates?

Yes; the compressors are linked from tip to tip and the gates from ring to ring of the TRS jack lead. So, leaving the sleeves connected and disconnecting either of those lines will enable the other to function as a stereo pair alone (whilst the disconnected one will act individually, as two separate comps/gates, on each mono signal).

11. I own an ISA 430. Can I link the dynamics to a MKII for use as a stereo pair?

Yes; simply connect a link cable as described above. N.B. the ISA 430 MKII's compressor must be set to VCA mode.

12. Does the ISA 430 MKII have the same kind of spectacular bandwidth that has given the Red range its reputation for 'open-ended' sound?

Yes. The bandwidth of the ISA 430 MKII is 10Hz to 200kHz!

13. Can I use all the different sections of the ISA 430 MKII at once?

Yes. If you want to use the mic pre, hi- and lo- pass filters, parametric and shelving EQ, compressor, expander/gate, de-esser, limiter and digital output all at the same time, as one huge 'super channel,' you can. You can also take any section out of the signal path independently with a single button push. Or you could use the ISA 430 MKII in 'split mode.'

14. What is 'split mode'?

Split mode allows the ISA 430 MKII to act as separate processors at the same time, handling totally separate audio signals. So one channel of audio can be routed through the EQ sections, with a second, discrete audio channel being routed through the dynamics sections. Furthermore, if the mic pre-amp is also being utilised to output direct to a recording format as well as the ADC dealing with 2 further signals, the unit is acting as four separate processors at once!

15. Can I route any EQ sections to the dynamics?

Yes: the hi- and lo- pass filters, the low-mid and hi-mid parametric EQ, and the hi- and lo- shelving EQ can all be routed independently to the sidechain of the compressor, or to the sidechain of the gate. This means that you can control the action of the compressor the gate from any individual section of EQ ('frequency selective compression'). Also, you have a 'listen' button in the compressor, gate and de-esser sections, which allows you to monitor whatever is feeding the sidechain of each section so that you can easily hear and tune the frequency you want to trigger each dynamics processor. There's even a separate 'listen' LED by the main meter to warn you that you are listening to something other than the main output – like a 'PFL' warning light on a mixing console. The VU meter can also be selected to view the sidechain for additional control.

16. Can I use the ISA 430 MKII as a 24-bit/192kHz stereo A/D converter?

Yes – the external input, plus the line input (bypass on) or the ADC inputs can be used as a stereo feed to the optional A/D converter. They also pass through the soft limiter before reaching the A/D, preventing digital clipping.

17. What if I want to use the mic pre-amp in isolation?

There's a Post-Mic Pre-output which allows you to take signal out of the ISA 430 MKII from a point immediately after the mic pre. Using the ISA 430 MKII in this way provides a very short signal path to tape, for ultra-clean recordings. Also, connecting the Post-Mic Pre-output does not interrupt the signal flow from mic pre-to EQ, dynamics etc, so a direct feed to tape can be achieved whilst simultaneously allowing processing of the same source signal.

18. The Air switch sounds great but what's actually happening to my signal?

This feature increases the impedance effect of the transformer on high frequencies, adding further "air" to its sonic quality. It does this by including an inductor circuit into the secondary of the transformer, giving the pre-amp an input impedance that varies with the frequency, having a smaller voltage drop at the top-end. So, additional clarity is introduced by the interaction between the mic and pre-amp alone, without EQ.

19. What if I experience problems with the gate 'chattering'?

The ISA 430 MKII is equipped to deal with this – simply pressing the Hyst button, which introduces hysteresis,

solves the problem. Gates sometimes 'chatter' when the source audio is just above or just below the threshold level, as the gate is constantly trying to open/close/open/close etc. Hysteresis reduces the dB level at which the gate closes from (e.g.) -55dB to -65dB. Thus even if a signal is modulating whilst fading out, the gate is prevented from 'chattering.' Since hysteresis is non-destructive in terms of having no other effect on audio, the Hyst button should be left on most of the time when using the gate.

20. The limiter is described as 'soft limiting' What does that mean?

Derived from the groundbreaking soft limiter featured in the ISA 428 Pre-Pack, the opto-circuit has different ratios as it approaches peak 'full scale' level (0dBFS), whereby the ratio becomes infinity:1. This creates a softer limiting effect but still ensures that the maximum level isn't exceeded.

21. How does the de-esser work?

The de-esser uses Focusrite's proprietary phase invert technology. Once the user has selected the frequency at which the de-ess is to occur, the ISA 430 MKII generates a 180° out-of-phase signal at that frequency which cancels the specific frequency selected at the moment it occurs, without having a negative effect on other related frequencies.

22. When I travel internationally can I take my ISA 430 MKII with me?

No problem. The power supply is a multi-tap design, so all you need to do is turn the fuse holder around to change the voltage to match whichever country you are in.

23. Why is a Superclock/x256 input important?

If a customer has a Pro Tools TDM system and wants to lock it to an external analogue multi-track (s)he needs a USD (Universal Slave Driver, Digi's premier sync box). This box looks at the speed of incoming timecode and then varies the Superclock frequency up and down to match. Therefore, because the Superclock is basically 256 times the speed of word clock, the playback or record speed of Pro Tools is matched (very accurately) to the machine's speed and any attached Digi. Audio interfaces will also be adjusted.

If the customer now wants to record off the multitrack into Pro Tools via an ISA box, they have a problem if they don't have a Superclock input because the ISA would be running off its own internal crystal and not looking at the speed information being calculated by the USD. It would be running at precisely 44.1 or 48k with a very high stability, however the analogue deck would be 'wowing and fluttering' all over the show.

Therefore by providing a Superclock input, you can use the USD to clock the ISA module, and therefore lock the ISA up to anything you are locking Pro Tools up to.

Also any TDM Pro Tools equipped with a USD can be switched into varispeed mode. Using Pro Tools' Session Setup window, a slider allows the overall speed of Pro Tools to be moved up or down. This is achieved by telling the USD to adjust its internal clock and therefore its Superclock output. This varied Superclock output then

feeds any Digi interface as above. So if a customer wants to use an ISA 430 MKII, but at the same time varispeed Pro Tools, they need a Superclock input.

24. Is there an optional digital input card?

No, because all the processing in the ISA 430 MKII is entirely analogue – so even if there was a digital input, the digital signal would have to be immediately passed through a D/A converter to allow processing!

25. Does the card include dithering?

Yes, the wordlength of a 24-bit input can truncated down to 20 or 16 bits and then dithered prior to digital output.

26. Why are the Int. A/D and Ext. A/D inputs fed to the digital output card via the limiter?

The input to the A/D converter must not exceed 0dBfs in order to prevent digital clipping. The limiter therefore comes after the A/D converter inputs so that the user is protected from digital clipping.

27. Can I lock straight to Pro Tools from the digital output of the ISA 430 MKII?

Yes, the digital output board is designed so that it can synchronise to external word clock signals, or to Digidesign's Superclock.

28. Why is the 24-bit 192kHz specification important?

An A/D converter works by sampling the audio waveform at regular points in time, and then quantising those values into a binary number, which relates to the number of bits specified. The quantised signal must then be passed through a D/A converter before it becomes audible. In simple terms, the D/A essentially 'joins the dots' plotted by the A/D converter when the signal was first converted to digital. The number of dots to join, combined with how little those dots have been moved, determines how accurate the final signal will be compared to the original.

The greater the sample rate and bit rate, the more accurate the whole digital process is. So 24-bit/192 kHz performance will ensure more accurate digital transfer of your audio

information compared to the old 16-bit/ 44.1kHz standards. (You can still use these standards for compatibility reasons if you need to as the ISA 430 MKII also allows 16-bit/44.1 kHz operation.)

29. Can I retrofit a digital board to an analogue ISA 430 MKII at a later date?

Yes, you can do it yourself – it can easily be retro-fitted by the customer without any soldering etc. – just a few screws to undo, and one clip-connector to join to the main PCB.

30. What are the differences between the ISA 430 MKII and the ISA 430?

The MKII has variable mic pre-amp impedance, as featured on the ISA 428 Pre-Pack, allowing the performance of the unit and microphone connected to be tailored to a suitable level and response. The MKII runs up to 192kHz, with 1- and 2-wire modes selectable at the rear plus SPDIF available on optical cable. The MKII has dBFS metering on the right hand side with optional viewing of the ADC inputs, as well as a VU meter with selectable calibration and additional sidechain view.

The compressor on the new model has a variable blend, with a dial to adjust the mix, and contains VCA and opto-circuitry. The "limiter-configurable" nature of the opto means there are a total of three types of compressor. Also, the auto release now has its own dedicated switch and the compressor can be positioned post-sum or pre-EQ. The soft limiting of the MKII can be used on analogue and digital outputs simultaneously.

The MKII's shelving includes 2 extra frequencies per band: 20 and 655Hz for LF and 1.5 and 2.2kHz for HF. The mic pre-amp transformer features an optional inductor circuit for boosting HF and adding 'air' to the signal, and its gain controls are identical to the ISA 428.

There are two inserts on the MKII, both being "split-configurable" with movable routing facilities. Lastly, the MKII's ADC inputs are both XLR and the line input is now routed through the input transformer as with the ISA 220 and 428.

Specifications

Mic input

- Connector: XLR
- Signal: Balanced (Transformer)
- Operating Level: +4dBu
- Gain Range: 0 to +60dB in 10dB steps
- Input Impedance: variable as follows:

Impedance setting	Equivalent input impedance (1Khz)
Low	600Ω
ISA 110	1400Ω
Med (Medium)	2400Ω
High	6800Ω

- EIN (equivalent input noise) = -128dB measured at 60dB of gain with 150Ω terminating impedance and 20Hz-22kHz bandpass filter
- Noise at main output with gain at unity (0dB) = -97dBu measured with a 20Hz/22kHz bandpass filter
- Signal to noise ratio relative to max headroom (28dBu) = 125dB
- Signal to noise ratio relative to 0dBfs (+22dBu) = 119dB
- THD at medium gain (30dB) = 0.001% measured with a 1KHz -20dBu input signal and with a 20Hz/22kHz bandpass filter
- Frequency response at minimum gain (0dB) = -0.25dB down at 20Hz and -3dB down at 120kHz
- Frequency response at maximum gain (60dB) = -2.5dB down at 20Hz and -3dB down 120kHz
- CMRR at full gain (60dB) = 80dB

Line input

- Connector: XLR
- Signal: Balanced
- Operating Level: +4dBu
- Gain range = -20dB to +10dB in 10dB steps
- Input Impedance = 10kΩ from 10Hz to 200kHz
- Noise at main output with gain at unity (0dB) = -91dBu measured with a 20Hz/22kHz bandpass filter
- Signal to noise ratio relative to max headroom (28dBu) = 119dB
- Signal to noise ratio relative to 0dBfs (+22dBu) = 113dB
- THD at unity gain (0dB) = .002% measured with +4dBu input signal and with a 20Hz/22kHz bandpass filter
- Frequency Response at unity gain (0dB) = 0.25dB down at 20Hz and -3dB down at 140kHz

Instrument input

- Connector: Mono Jack
- Signal: Unbalanced
- Gain range = 10dB to 40dB continuously variable
- Input Impedance = >1MΩ
- Noise at minimum gain (0dB) = -90dBu measured with a 20Hz/22kHz bandpass filter
- Noise at maximum gain (40dB) = -78dBu measured with a 20Hz/22kHz bandpass filter
- THD at minimum gain (0dB) = .006% measured with -10dBu input signal and with a 20Hz/22kHz bandpass filter
- Frequency Response at 10dB gain = 0.2dB down at 26Hz and 0dB at 32kHz

- Frequency Response at 40dB gain = -3dB down at 26Hz and -3dB down at 32kHz

Post-Mic output

- Connector: XLR
- Signal: Balanced
- Operating Level: +4dBu
- Maximum O/P Level: +26dBu
- Signal is routed directly from the pre-amp after the gain stage, trim and phase reverse circuits of the input section, and can be fed from the mic, line or instrument inputs

Insert 1 Send

- Connector: XLR
- Signal: Balanced
- Operating Level: +4dBu
- Maximum O/P Level: +26dBu
- This output has two modes of operation:
 - i) INSERT 1 IN; the connector is an output from the point in the signal path that is post-the phase switch circuit
 - ii) EQ SPLIT; the connector is the output of the EQ section of the module

Insert 1 Return

- Connector: XLR
- Signal: Balanced
- Operating Level: +4dBu
- Maximum I/P Level: +26dBu
- This input has two modes of operation:
 - i) INSERT 1 IN; the connector is the return or input to the signal path that is post-the phase switch circuit
 - ii) EQ SPLIT; the connector is the input into the EQ section of the module

Insert 2 Send

- Connector: XLR
- Signal: Balanced
- Operating Level: +4dBu
- Maximum O/P Level: +26dBu
- This output has two modes of operation:
 - i) INSERT 2 IN, the connector is an output from the point in the signal path determined by the Post-Dyn, Dynamics Pre-EQ and Post-Sum buttons
 - ii) DYN SPLIT; the connector is the output of the dynamics section of the module

Insert 2 Return

- Connector: XLR
- Signal: Balanced
- Operating Level: +4dBu
- Maximum I/P Level: +26dBu
- This input has two modes of operation:
 - i) INSERT IN; the connector is the return or input to the signal path determined by Post-Dyn, and the Dynamics Pre-EQ and Post-Sum buttons
 - ii) DYN SPLIT; the connector is the input into the dynamics section of the module

Main Output

- Connector: XLR
- Signal: Balanced
- Operating Level: +4dBu
- Maximum O/P Level: +26dBu

Dynamic Link

- Connector: TRS Jack
- Signal: Tip = Compressor, Ring = Gate
- Links two ISA 430 MKII units to allow control of the dynamics section of both units from one unit giving accurate stereo dynamics control

Gate Key I/P + Comp Key I/P

- Connector: TRS (Stereo) Jack
- Signal: Balanced
- Operating Level: +4dBu
- Maximum I/P Level: +26dBu
- Drive the sidechains of the gate and compressor respectively. N.B Comp Key I/P is not available in Vintage mode.

ADC Input 1/Ext Sum Input

- Connector: XLR
- Signal: Balanced
- Operating Level: +4dBu
- Maximum I/P Level: +22dBu=0dBfs in ADC input mode, +26dBu in Ext Sum input mode

ADC Input 2

- Connector: XLR
- Signal: Balanced
- Maximum I/P Level: +22dBu=0dBfs

EQ (Shelving)

- Gain range: +/-18dB
- LF: 20Hz, 56Hz, 160Hz, 460Hz
- LF (Hi Range in): 33Hz, 95Hz, 270Hz, 655Hz
- HF: 1k5Hz, 3k3Hz, 6k8Hz, 15kHz
- HF (Hi Range in): 2k2Hz, 4k7Hz, 10k, 18k

EQ (Parametric)

- Gain range: +/-18dB
- Variable Q
- LMF: 40-400Hz
- LMF (x3 in): 120-1200Hz
- HMF: 600-6kHz
- HMF (x3 in): 1k8-18kHz

EQ (Filters)

- 3rd Order
- 18dB/Octave
- LPF: 400Hz-22kHz
- HPF: 20Hz-1k6Hz

Compressor (Class A VCA mode)

- Threshold Range: -28dB to +12dB
- Ratio: 1.5:1 to 10:1
- Slope: Soft knee
- Attack: 100µs to 100ms
- Release: 100ms to 7s, variable or auto (program dependent)

Compressor (Vintage Opto mode)

- Threshold Range: -28dB to +12dB
- Ratio: 1.5:1 to 5:1 in Comp mode 5:1 to 20:1 in Lim mode
- Slope: Soft knee in Comp mode, Hard knee in Lim mode
- Attack: Fixed
- Release: Fixed

Limiter

- Threshold = -6dBfs (+16dBu)
- Attack time = instant
- Release time = instant
- Noise = -95dBu measured with a 20Hz/22kHz bandpass filter
- Limiter ratio is level dependent as follows:

Signal level	Input to output level reduction ratio
-6dBfs to -4dBfs	1.5:1
-4dBfs to 0dBfs	2:1
0dBfs to +6dBfs	Infinite:1

Gate

- Threshold Range: -40dB to +10dB
- Gate Range: 0 to -80dB
- Attack: switched fast or slow
- Release: 100ms to 5s
- Hold: 20ms to 4s
- Expander Ratio: 0 to 5:1

De-Esser

- Threshold Range: 22dBu
- Frequency Range: 2k2Hz to 9k2Hz
- Ratio at Centre
- Frequency 2:1

Weight

- 7kg (unpacked)

Dimensions

- 484 x 250 x 88mm (2U rackmount)

Accuracy

Whilst every effort has been made to ensure the accuracy and content of this manual, Focusrite Audio Engineering Ltd makes no representations or warranties regarding the contents.

Copyright

Copyright 2003 Focusrite Audio Engineering Ltd. All rights reserved. No part of this manual may be reproduced, photocopied, stored on a retrieval system, transmitted or passed to a third party by any means or in any form without the express prior consent of Focusrite Audio Engineering Ltd.

Warranty

All Focusrite products are covered by a warranty against manufacturing defects in material or craftsmanship for a period of one year from the date of purchase. Focusrite in the UK, or its authorised distributor worldwide will do its best to ensure that any fault is remedied as quickly as possible. This warranty is in addition to your statutory rights.

This warranty does not cover any of the following:

- Carriage to and from the dealer or factory for inspection or repair labour charge if repaired other than by the distributor in the country of purchase or Focusrite in the UK.
- Consequential loss or damage, direct or indirect, of any kind, however caused.
- Any damage or faults caused by abuse, negligence, improper operation, storage or maintenance.

If a product is faulty, please first contact your dealer in the country of purchase; alternatively, contact the factory. If the product is to be shipped back, please ensure that it is packed correctly, preferably in the original packing materials. We will do our best to remedy the fault as quickly as possible.

Reset Sheet



POWER



Focusrite
Producer Pack

Meter 0 Vu Calibration
Mixer 0 Vu Listen
+4 dBu
+18 dBu
Audio Out Comp

Meas Source

INST INPUT

Input
Listen
Inst
Inst
Comp

30.50 36.60 Hz
10.0 1.0 Line
0.30 3.0

Select
Mic
Line
Inst

Phase

Mic Pre Amp
Inst

30.00
+8V
+10
+20
+40
+80
+160

Phase

High

400
200
100
50

EQ Split
EQ

800
400
200
100
50

Filter In
Comp

100
50
20
10

Comp

11
10
9
8
7
6
5
4
3
2
1

Auto
Release
Thresh

0
10
20
30
40
50
60
70
80
90
100

Auto
Release
Thresh

180
160
140
120
100
80
60
40
20
0

Band
Range
Threshold

0
20
40
60
80
100
120
140
160
180

Gain
Range
Threshold

100
500
1000
500
100

Filter Att
Hold
Release

0
10
20
30
40
50

Auto
Release
Thresh

0
10
20
30
40
50
60
70
80
90

Auto
Release
Thresh

0
10
20
30
40
50
60
70
80
90

Auto
Release
Thresh

100
50
20
10

Comp

100
50
20
10

Comp

100
50
20
10

Comp

100
50
20
10

Comp

100
50
20
10

Comp

100
50
20
10

Comp

100
50
20
10

Comp

100
50
20
10

Comp

100
50
20
10

Comp

100
50
20
10

Comp

100
50
20
10

Comp

100
50
20
10

Comp

100
50
20
10

Comp

100
50
20
10

Comp

100
50
20
10

Comp

100
50
20
10

Comp

100
50
20
10

Comp

100
50
20
10

Comp

100
50
20
10

Comp

100
50
20
10

Comp

100
50
20
10

Comp

100
50
20
10

Comp

100
50
20
10

Comp

100
50
20
10

Comp

100
50
20
10

Comp

100
50
20
10

Comp

100
50
20
10

Comp

100
50
20
10

Comp

100
50
20
10

Comp

100
50
20
10

Comp

100
50
20
10

Comp

100
50
20
10

Comp

100
50
20
10

Comp

100
50
20
10

Comp

100
50
20
10

Comp

100
50
20
10

Comp

100
50
20
10

Comp

100
50
20
10

Comp

100
50
20
10

Comp

100
50
20
10

Comp

100
50
20
10

Comp

100
50
20
10

Comp

100
50
20
10

Comp

100
50
20
10

Comp

100
50
20
10

Comp

100
50
20
10

Comp

100
50
20
10

Comp

100
50
20
10

Comp

100
50
20
10

Comp

100
50
20
10

Comp

100
50
20
10

Comp

100
50
20
10

Comp

100
50
20
10

Comp

100
50
20
10

Comp

100
50
20
10

Comp

100
50
20
10

Comp

100
50
20
10

Comp

100
50
20
10

Comp

100
50
20
10

Comp

100
50
20
10

Comp

100
50
20
10

Comp

100
50
20
10

Comp

100
50
20
10

Comp

100
50
20
10

Comp

100
50
20
10

Comp

100
50
20
10

Comp

100
50
20
10

Comp

100
50
20
10

Comp

100
50
20
10

Comp

100
50
20
10

Comp

100
50
20
10

Comp

100
50
20
10

Comp

100
50
20
10

Comp

100
50
20
10

Comp

100
50
20
10

Comp

100
50
20
10

Comp

100
50
20
10

Comp

100
50
20
10

Comp

100
50
20
10

Comp

100
50
20
10

Comp

100
50
20
10

Comp

100
50
20
10

Comp

100
50
20
10

Comp

100
50
20
10

Comp

100
50
20
10

Comp

100
50
20
10

Comp

100
50
20
10

Comp

100
50
20
10

Comp

100
50
20
10

Comp

100
50
20
10

Comp

Focusrite Distributors

Australia

Electric Factory Pty Ltd.
Phone: +61 3 9480 5988
Fax: +61 3 9484 6708
Email: elfa@ozmail.com.au

Austria

Trius Vertrieb GmbH and Co KG
Phone: +49 54 51 940 80
Fax: +49 54 51 940 829
Email: trius@trius-audio.de

Belgium

Audio XL NV
Phone: +32 11 232355
Fax: +32 11 232172
Email: info@audioxl.be

Brazil

Pride Music
Phone: +55 11 6975-2711
Fax: +55 11 6975-2772
Email: info@pridemusic.com.br

Bulgaria

Bulcomp Ltd
Phone: +35 932 652758
Email: info@bulcomp.com

Canada

c/o Digidesign (USA)
Phone: +1 650 731 6300
+1 866 FOCUSRITE
Fax: +1 650 731 6399
Email: prodinfo@digidesign.com
Dino_Virella@digidesign.com

Croatia, Slovenia, Bosnia, Macedonia and Serbia

Music Export
Phone: +49 89 746 123 90
Fax: +49 89 746 123 92
Email: Music.Exports@t-online.de

Cyprus

Technosound
Phone: +357 2 499971
Fax: +357 2 499986
Email: technosd@cylink.com.cy

Czech Republic

Mediaport
Phone: +420 2 7173 5610
Fax: +420 2 7273 4897
Email: info@mediaport.cz

Denmark

New Musik AG
Phone: +45 86 190899
Fax: +45 86 193199
Email: info@newmusik.dk

Egypt

Alpha Audio
Phone: +202 245 6199
Fax: +202 247 8969
Email: aaudio@intouch.com

Finland

Studiotec Ky
Phone: +358 9 5123 5330
Fax: +358 9 5123 5355
Email: sales@studiotec.fi

France

Audiopole (Tam Tam Audio)
Phone: +33 1 45 144780
Fax: +33 1 45 144790
Email: commercial@audiopole.fr

Germany

Trius Vertrieb GmbH and Co KG
Phone: +49 54 51 940 80
Fax: +49 54 51 940 829
Email: trius@trius-audio.de

Greece

Bon Studio S.A.
Phone: +30 1 3809605-8
Fax: +30 1 3827868
Email: bon@bonstudio.gr

Hong Kong/China

Digital Media Technology
Phone: +852 2721 0343
Fax: +852 2366 6883
Email: dmthk@dmtpo.com

Hungary

Absolute
Phone: +361 252 0196
Fax: +361 341 0272
Email: ad@absolute.hu

Iceland

Exton
Phone: +354 551 2555
Fax: +354 562 6490
Email: exton@exton.is

India

R & S Electronics
Phone: +91 22 636 9147
Fax: +91 22 636 9691
Email: randsm@vsnl.com

Indonesia

PT Santika Multi Jaya
Phone: +62 21 650 6040
Fax: +62 21 650 880
Email: yupo@indosat.net.id

Israel

Sontronics
Phone: +972 3 570 5223
Fax: +972 3 619 9297
Email: sontrncs@inter.net.il

Italy

Grisby Music Professional
Phone: +39 0 71 7108471
Fax: +39 0 71 7108477
Email: grisbysmusic@tin.it

Japan

All Access Inc
Phone: +81 52 443 5537
Fax: +81 52 443 7738
Email: info@allaccess.co.jp

R. O. Maldives

Island Acoustics
Phone: +960 32 0032
Fax: +960 31 8624
Email: islmusic@dhivehinet.net.mv

Mexico

Vari Internacional S.A. de C.V.
Phone: +52 5605 9555
Fax: +52 5605 9555
Email: ventaspa@varinter.com.mx

Netherlands

Total Audio BV
Phone: +31 20 4476447
Fax: +31 20 4476464
Email: info@total-audio.nl

New Zealand

Protel
Phone: +64 4 801 9494
Fax: +64 4 384 2112
Email: rob@wm.protel.co.nz

Norway

Lydrommet
Phone: +47 22 80 94 50
Fax: +47 22 80 94 60
Email: admin@lydrommet.no

Poland

Music Info
Phone: +48 12 267 2480
Fax: +48 12 267 2224
Email: info@music.com.pl

Portugal

Caius Tecnologias
Phone: +35 122 208 6009
Fax: +35 122 208 5969
Email: caius@mail.telepac.pt

Romania

A.F. Marcotec (Bucharest)
Phone: +40 1 337 1254
Fax: +40 1 337 1254
Email: marcotec@arexim.ro

Russia, Baltics, Ukraine

AT Trade
Phone: +7 095 956 1105
Fax: +7 095 956 6882
Email: alpha-brand@attrade.ru

Singapore/Malaysia

Team 108
Phone: +65 748 9333
Fax: +65 747 7273
Email: 108@team108.com.sg

Slovakia

Centron
Phone: +421 264 780767
Fax: +421 264 780042
Email: centron@ba.profinet.sk

South Africa

Eltron Pty Ltd
Phone: +27 11 787 0355
Fax: +27 11 787 9627
Email: eltron@iafrica.com

South Korea

Best Logic Sound Co.
Phone: +82 2 515 7385
Fax: +82 2 516 7385
Email: bscoltd@hitel.net

Spain

Media Sys S.L
Phone: +34 93 426 6500
Fax: +34 93 424 7337
Email: mediasys@mediasys.es

Sri Lanka

HiFi Centre Ltd
Phone: +94 1 580442
Fax: +94 1 503174
Email: hifi@eureka.lk

Sweden

Polysonic ab
Phone: +46 31 7069050
Fax: +46 31 7069110
Email: polysonic@polysonic.com

Switzerland

Bleuel Electronic ag
Phone: +41 1 751 7550
Fax: +41 1 751 7500
Email: bleuel-elec@swissonline.ch

Taiwan

Digital Media Technology (DMT)
(Taiwan) Ltd
Phone: +886 2 25164318
Fax: +886 2 25159881
Email: dmtp@dmtpo.com

Thailand

KEC
Phone: +66 2 222 8613/4
Fax: +66 2 225 3173
Email: kec@loxinfo.co.th

United Arab Emirates

NMK Electronics Ent.
Phone: +971 4626683
Fax: +971 626682
Email: nmk@emirates.net.ae

United Kingdom & Ireland

Focusrite Audio Engineering Ltd
Phone: +44 (0) 1494 462246
Fax: +44 (0) 1494 459920
Email: sales@focusrite.com

USA

Digidesign
Phone: +1 630 731 6300
+1 866 FOCUSRITE
Fax: +1 650 731 6399
Email: prodinfo@digidesign.com
Dino_Virella@digidesign.com

Venezuela

Avcom C.A.
Phone: +58 212 237 7762
Fax: +58 212 237 8275
Email: jmendez@avcom.com.ve

Vietnam

Vistar
Phone: +84 4 824 3058
Fax: +84 4 825 0099
Email: hanoimusic@netnam.org.vn

Other territories not listed:
Please contact Focusrite United Kingdom