

# vocaster one

User Guide

Tell the world  
Version 1

Focusrite.com



# Contents

Overview . . . . .	3	Recording a phone . . . . .	17
Introduction . . . . .	3	Recording to a video camera . . . . .	18
Hardware features . . . . .	4	Vocaster Hub software . . . . .	19
In the Box . . . . .	4	Controlling the microphone . . . . .	20
System requirements . . . . .	4	Controlling your mix . . . . .	21
Getting Started . . . . .	5	Recording sounds from your computer . . . . .	22
Easy Start Tool . . . . .	5	Example of Loopback usage . . . . .	23
Mac Users: . . . . .	6	Recording Tracks into Software . . . . .	23
Windows Users: . . . . .	7	Hardware Features . . . . .	24
iPad Users: . . . . .	8	Top Panel . . . . .	24
All users: . . . . .	9	Rear Panel . . . . .	25
Manual Registration . . . . .	9	Specifications . . . . .	26
Audio Setup in your DAW . . . . .	9	Performance Specifications . . . . .	26
Audio Setup in Hindenburg . . . . .	10	Troubleshooting . . . . .	28
Examples of use . . . . .	11	Copyright and Legal Notices . . . . .	28
Recording with a microphone . . . . .	11	Credits . . . . .	28
Using Auto Gain . . . . .	13		
Manual gain adjustment . . . . .	14		
Microphone Mute . . . . .	15		
Using Enhance . . . . .	15		
Listening with headphones . . . . .	16		
Listening with speakers . . . . .	16		

## Overview

### Introduction

Welcome to your new Vocaster One audio interface. Vocaster One is designed for podcasters, vloggers, voiceover artists, streamers, audiobook creators, and more.

With Vocaster One and the included Vocaster Hub software you can record studio quality audio to your computer and camera.

We've designed Vocaster One for users of all experience levels. With features such as Auto Gain and Enhance you can achieve clear and consistent recordings quickly.

The Vocaster Hub software is designed with simplicity in mind. It provides easy access for controlling Vocaster's settings, and gives you full control of your show's mix as you send it to your choice of recording and streaming software.

Connect Vocaster One to a computer via its USB-C port and the cable provided. You can either live-stream audio in real time, or record sound for later edit and upload.

Vocaster One also allows two-way connection to a phone, letting you record interviews or other audio from your phone to your camera or computer. You can also record to the audio track of a camera in perfect sync with your video. You can monitor your stream or recording process on either headphones or loudspeakers.

The Vocaster One interface and the included Vocaster Hub control software support both Mac and Windows.

Vocaster One is also compatible with Apple iPads with a USB-C port, so you can take advantage of the additional portability and convenience the tablet format provides.

If you can't find what you need in this User Guide, please visit [support.focusrite.com](https://support.focusrite.com), which has a Getting Started section, setup guides, and technical support.

A video series explaining how to set up and use Vocaster One is available from our [Get Started pages](#).

### Hardware features

Vocaster One allows you to connect a high quality microphone to a computer running macOS or Windows: this lets you achieve a much better audio recording than you would get by using the microphone built into most laptops or tablets.

The microphone input accepts a range of microphone models, including both dynamic and condenser types. If you are using a condenser microphone, Vocaster One can provide the phantom power (48V) it needs to operate.

The microphone signal routes to your computer's audio recording software via the USB-C connection at up to 24-bit resolution, and 48 kHz sample rate. (24-bit/48 kHz is the standard for most podcasts.)

If you don't already have recording software, we recommend Hindenburg. This is included in the software package available to you free of charge as a Vocaster owner.

A 3.5 mm jack socket allows you to connect a phone to Vocaster One: a second, similar socket allows connection to a video camera.

The phone connector is a TRRS: TRRS means you get audio both in and out of the phone, so you can record audio from the phone, and the phone can also hear the other audio sources you are recording to your show.

Vocaster One has outputs for both headphones and speakers: a front panel ¼' TRS socket for headphones and two rear panel ¼' TRS sockets for connection to speakers.

The top panel has knobs for microphone gain and listening level. The microphone control is surrounded by 'halo' meters, showing both the microphone signal level and the gain setting. Three illuminated buttons start the Auto Gain function, activate the Enhance feature and mute the microphone. There are also LEDs to show when phantom power and the USB connection are active.

### In the Box

Along with your Vocaster One you will find:

- USB cable, Type 'A' to Type 'C'
- Getting Started Information (printed inside the box)
- Important Safety Information

As a Vocaster One owner, you are also entitled to a selection of third-party software, including the Hindenburg DAW (Digital Audio Workstation) recording application. Go to [focusrite.com/Vocaster](https://focusrite.com/Vocaster) to see what's available.

### System requirements

The easiest way to check your computer's operating system (OS) is compatible with the Vocaster One is to use our [Help Centre's compatibility articles](#).

As new OS versions become available over time, you can continue to check for further compatibility information by searching our Help Centre at [support.focusrite.com](https://support.focusrite.com).

## Getting Started

When you connect Vocaster One for the first time, your computer recognises it in the same way as if it were a USB memory stick.

### Easy Start Tool

Getting up and running with your Vocaster One is made easy by our Easy Start Tool. To use this, connect Vocaster One to your computer with the USB cable supplied, and power it on by pressing the power button next to the rear panel USB port.

The following steps show you what will appear on screen: these help you get set up whether or not you're new to audio interfaces.



## GETTING STARTED

### Mac Users:

On connecting your Vocaster to your Mac you will see a pop-up and/or a Vocaster icon will appear on the desktop::

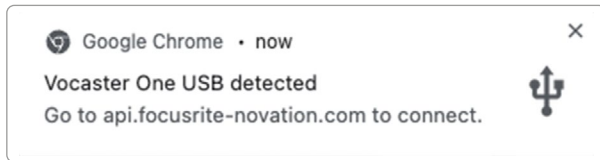

Google Chrome pop up



Vocaster Easy Start icon

Double-click on the icon or pop-up to open the Finder window shown below:

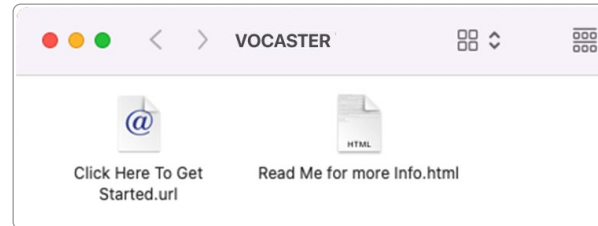

Double-click the **Click Here to Get Started.url** icon. This redirects you to the Focusrite website, where we recommend you register your Vocaster to access to your included software package:

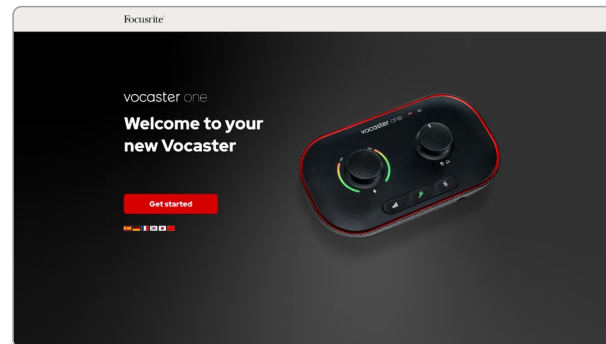

After you submit the form you can either follow our step-by-step setup guide, which is tailored to how you want to use Vocaster One, or go straight to your account and download Vocaster Hub control software.

When you connect Vocaster One, your computer should set it as your default audio device. If this doesn't happen, go to **System Preferences > Sound**, and ensure the input and output are set to **Vocaster One USB**.

## GETTING STARTED

### Windows Users:

On connecting your Vocaster One to your PC, this notification will appear:

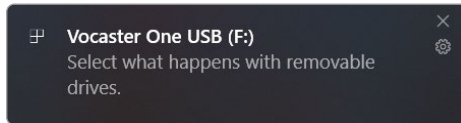

Click on the notification to open the dialogue box shown below:

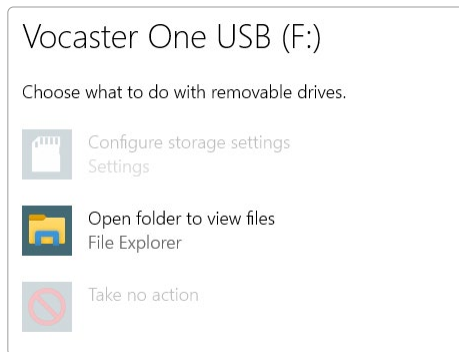

Double-click:

### Open folder to view files

this opens an Explorer window:

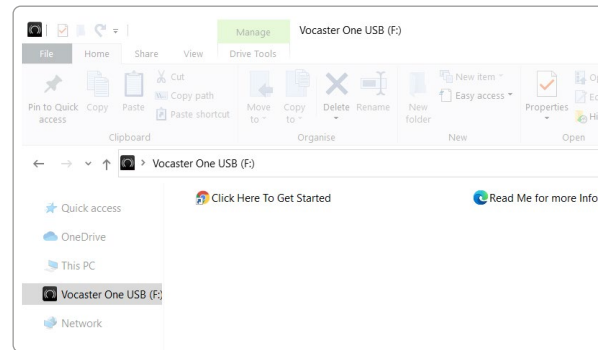

Double-click:

### Click Here to Get Started

This redirects you to the Focusrite website, where we recommend you register your device:

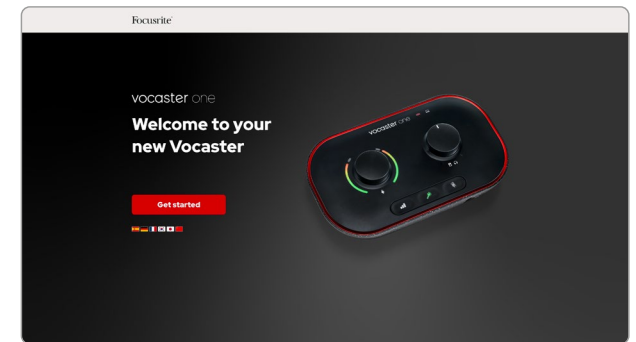

After you submit the form you can either follow our step-by-step setup guide, which is tailored to how you want to use Vocaster One, or go straight to your account and download Vocaster Hub control software.

When you connect Vocaster One, your computer should set it as your default audio device. If this doesn't happen, go to **Settings > System > Sound**, and set Vocaster One as the Input and Output Device.



## GETTING STARTED

### iPad Users:

**NOTE:** Before connecting Vocaster One to your iPad, we recommend you follow the 'Getting Started' section above to ensure your hardware is up to date through Vocaster Hub.

To connect your Vocaster One to an iPadOS device you need:

- iPad with USB-C port
- USB-C to USB-C cable (or the included cable and an Apple USB-A to C adaptor\*)

\*This method may require a separate USB hub to provide enough power to your Vocaster.

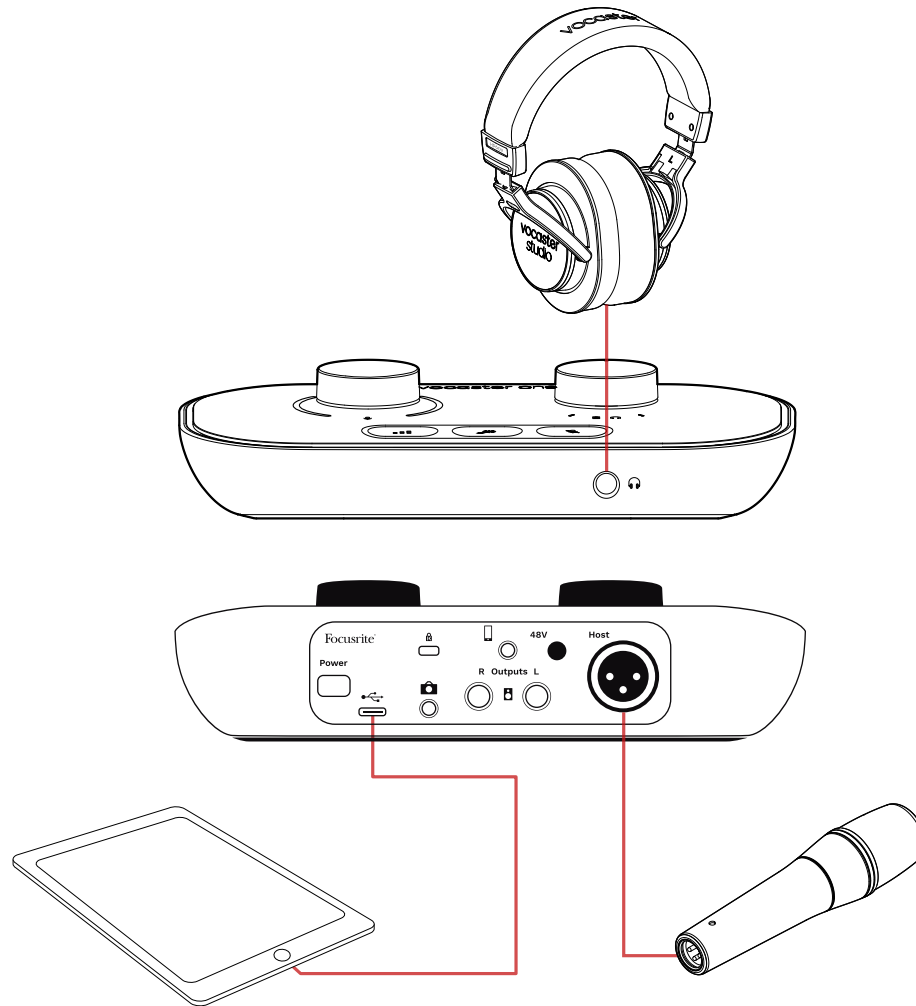

To make the connections:

1. Connect one end of the USB Type-C to C cable (or adaptor) to your iPad.
2. Connect the other end of the USB type-C to your Vocaster One's USB port.
3. Connect your headphones or monitor speakers to the Vocaster One.

Sound from the iPad routes to Vocaster One's outputs. You can route the microphone and other sources connected to the inputs of Vocaster One to iOS apps that support audio recording.



### All users:

If you have any issues using the Easy Start tool, open the file **More Info & FAQs**, where you should be able to find answers to your questions.

**NOTE:** When you install Vocaster Hub on a Windows computer, the driver needed by Vocaster One installs automatically. Vocaster Hub and the Vocaster Windows driver are always available to download at any time, even without registering: see 'Manual Registration' below.

### Manual Registration

If you decide to register your Vocaster One later you can do so at [register](#). You need to enter the Unique Product Number (UPN) manually: this number is on the base of the interface itself, and can also be found on the barcode label on the side of the box.

We recommend you download and install our Vocaster Hub software application, as this unlocks the full potential of the interface. You can download Vocaster Hub at any time from [downloads.focusrite.com](https://downloads.focusrite.com).

### Audio Setup in your DAW

Vocaster One is compatible with any Windows-based Digital Audio Workstation (this is the software you use to record and is referred to as a 'DAW') that supports ASIO or WDM, or any Mac-based DAW that uses Core Audio. After following the Easy Start procedure (see page 5), you can start using Vocaster One with the DAW of your choice.

Vocaster One lets you record all the sources separately via the USB connection, for mixing later, but also has a Show Mix input which is a stereo mix from Vocaster Hub software.

To allow you to get started if you do not already have a DAW application installed on your computer, Hindenburg is included; this is available to you once you've registered your Vocaster One. If you need help installing this, please visit our Getting Started pages [here](#), where a video tutorial is available.

Operating instructions for Hindenburg can be found in the application's Help files, or at [hindenburg.com/academy](https://hindenburg.com/academy).

Please note - your DAW may not automatically select Vocaster One as its default Input/Output (I/O) device. In this case, you must manually select Vocaster One/Focusrite USB ASIO as the driver on your DAW's Audio Setup\* page. Please refer to your DAW's documentation (or Help files) if you are unsure where to select the ASIO or Core Audio driver.

\*Typical names. Terminology may differ slightly between DAWs

## Audio Setup in Hindenburg

The examples opposite show the correct configuration on the Hindenburg audio preferences on Windows and Mac. There are two set ups, automatic and manual:

**Preferences** page (Mac version),

and at the

## Tools > Options > Audio tab

(Windows version).

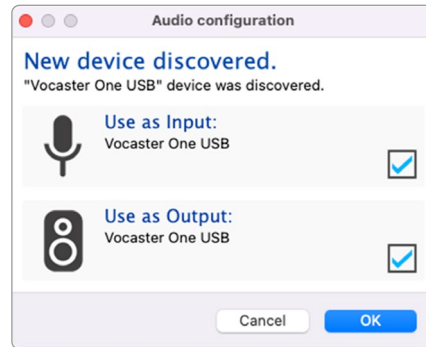

Mac automatic setup

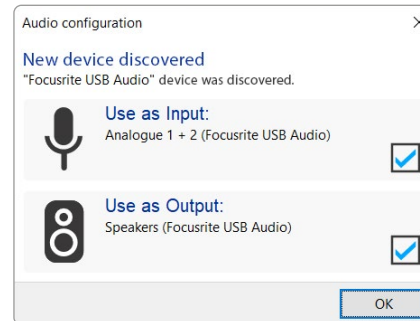

Windows automatic setup

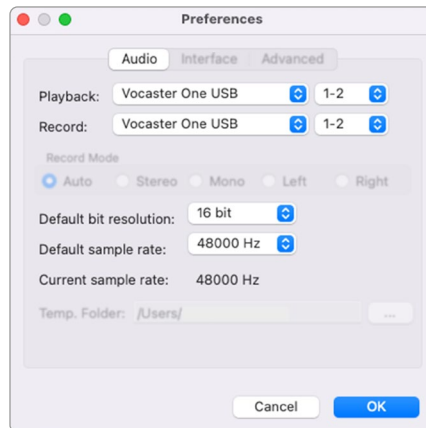

Mac manual setup

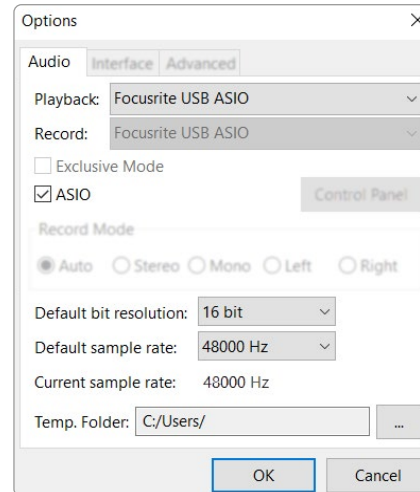

Windows manual setup

Tutorial videos explaining how to set up and use Vocaster One with various DAWs can be found at our [Getting Started](#) pages.

## Examples of use

Vocaster One is the ideal audio interface for live podcasting or voice recording, using a Mac, PC, or iPad. A typical set of connection possibilities is shown below.

### Recording with a microphone

This setup shows a typical configuration for recording from a microphone using software on your Mac, PC, or iPad. You can record your voice while listening to yourself and any other audio via headphones.

Apart from the headphone socket, all Vocaster One's connections are on the rear panel. Connect your computer or laptop to the USB port (marked ) using the USB cable supplied. Turn the unit on with the Power button.

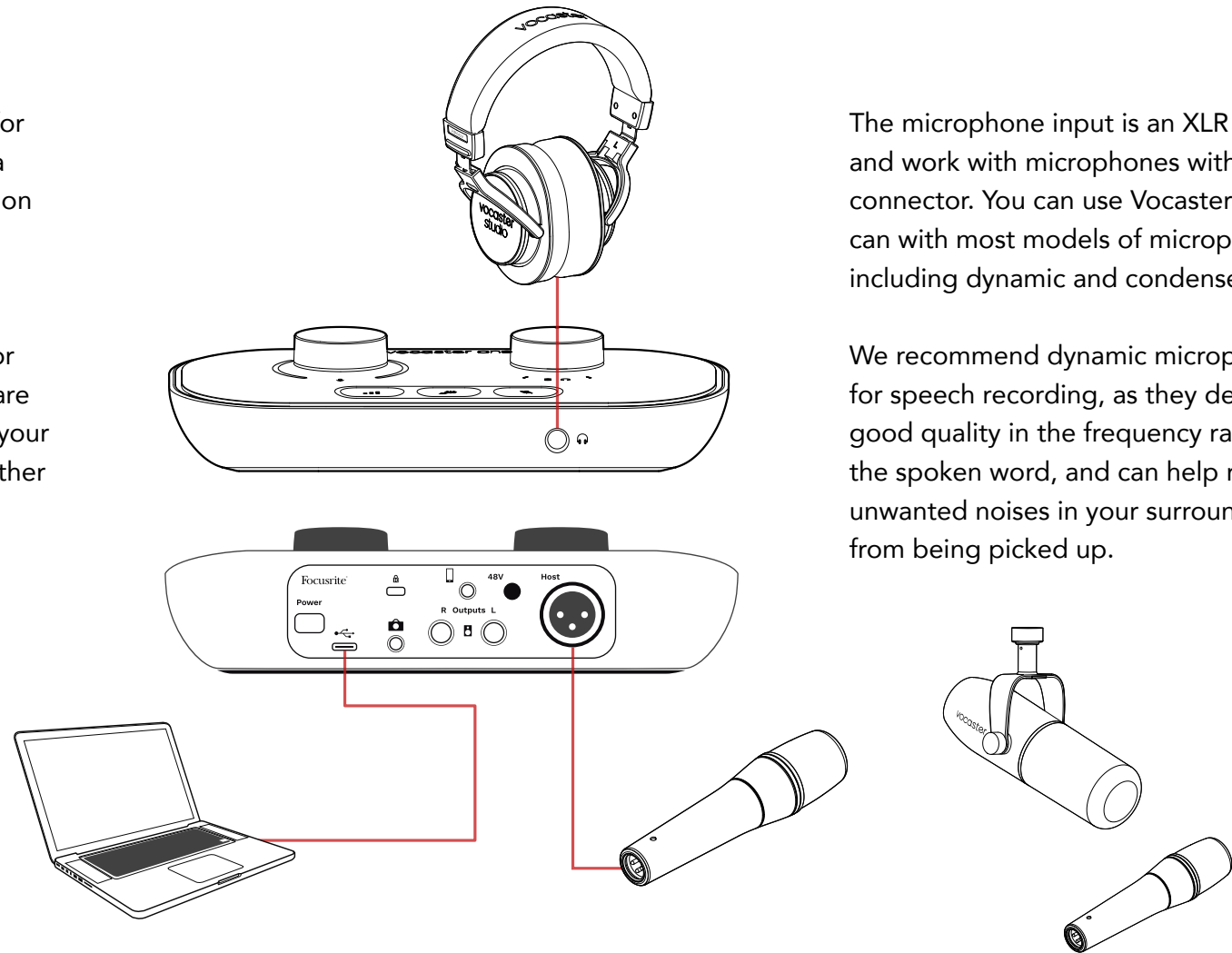

The microphone input is an XLR socket and work with microphones with an XLR connector. You can use Vocaster One can with most models of microphone, including dynamic and condenser types.

We recommend dynamic microphones for speech recording, as they deliver good quality in the frequency range of the spoken word, and can help reduce unwanted noises in your surroundings from being picked up.

Two types of dynamic microphone

## EXAMPLES OF USE

### Recording with a microphone (cont.)

Vocaster One can provide phantom power (48 volts) at the XLR input if you're using a condenser microphone. To enable phantom power, push the 48V button on the rear panel: the 48V LED lights red to confirm it's active.

Dynamic microphones do not require phantom power. It's rare, but you can damage some microphones using phantom power. We recommend turning off phantom power when you use a dynamic microphone. If you are unsure whether your microphone needs phantom power, please check its documentation.

### Microphone setup

Vocaster One has two ways of setting the correct microphone level. 'Gain' is the term we use to describe how much you are boosting your microphone signal.

You can either set the level automatically with Vocaster One's Auto Gain feature, or manually. Both methods are described in the next sections.



### Using Auto Gain

Vocaster One's Auto Gain feature allows you to get a good recording level without guesswork.

Press the  button to activate Auto Gain, if you have Vocaster Hub open on your computer, by clicking on the on-screen **Auto Gain** icon.

The Auto Gain button will pulse amber.



Vocaster One

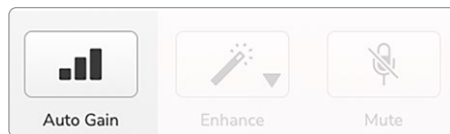

Vocaster Hub

Speak into the microphone for ten seconds, using a normal speaking voice you will use for the recording itself.

The halos acts as a count down timer, starting fully white, then moving towards the bottom. Vocaster Hub also shows a progress bar.

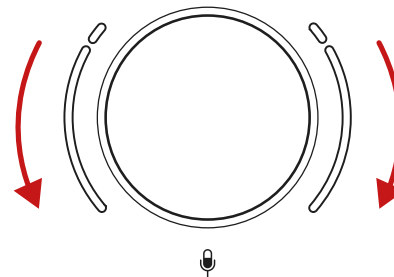

Halo countdown on Vocaster

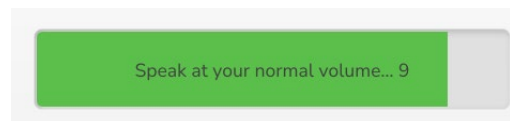

Vocaster Hub countdown

After ten seconds, Auto Gain sets the input level for the microphone and you're ready to record.

### Auto Gain didn't set my input level

If the halos flash amber the signal is too loud or too quiet so Auto Gain couldn't set the correct level and sets it to the minimum or maximum level.

If the halos flash red Auto Gain couldn't set a usable level. This could be due to a Mic Level that was too low:

- Test a different microphone or cable.
- Make sure 48V is on, if you're using a condenser microphone.
- Make sure you switch on your microphone (if it has an on/off switch).

## EXAMPLES OF USE

### Manual gain adjustment

On Vocaster One, the large knob marked  sets the microphone gain, and the level to your recording software.

The gain knob is surrounded by two LED 'halo' indicators, shaped as arcs. These light in various colours to show the microphone signal level.

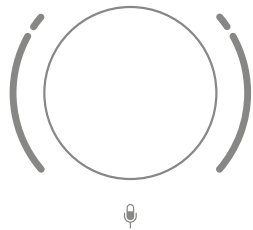

When you're adjusting the gain by turning the knob, the left halo changes to white to show the gain setting.

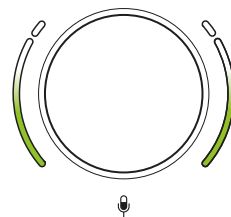
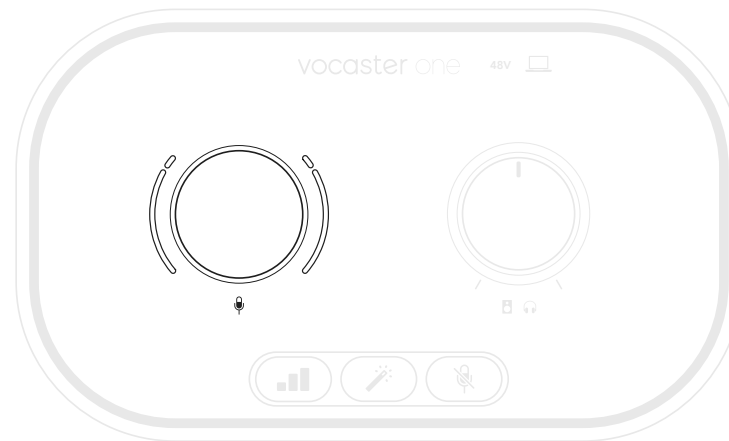

Good Level

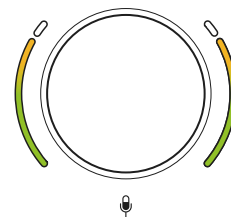

A bit too high

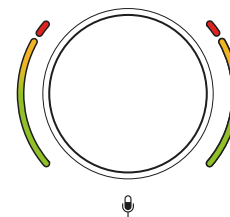

Your recording will distort

To set your gain, speak into your microphone as if you were recording, adjust the gain knob until the halo(s) just start to turn amber when you speak at your loudest. At this point, turn the knob down a bit until you don't see any amber. If the halos ever turn red, you will definitely need to turn the gain knob down: red means your recording is likely to distort. (See diagrams below.)

You can also adjust the gain from Vocaster Hub by moving the on-screen **Mic Level** slider: drag it to the right to increase the gain.

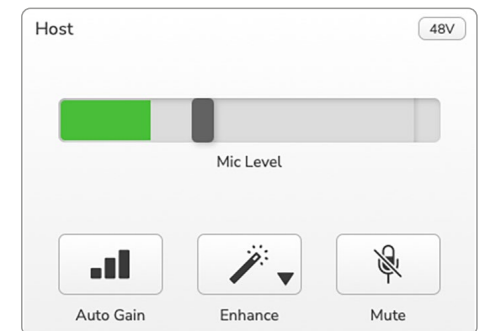

## EXAMPLES OF USE

### Microphone Mute

Vocaster One's microphone channel has a mute button, marked .



Vocaster One

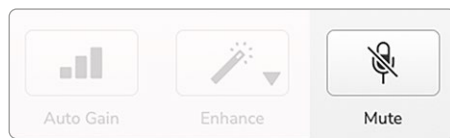

Vocaster Hub

You can press this at any time to turn the microphone 'off': the button lights red and the gain halos pulse red while the microphone is muted.

Press the button again to unmute. You can also click the button with the same icon on Vocaster Hub. (Broadcasters often refer to this feature as a 'cough switch'.)

### Using Enhance

Vocaster One's Enhance feature optimises the microphone's audio processing to achieve the best possible recording.

It uses compression to control the level of the microphone signal, equalisation to help voice recordings sound clearer and a high pass filter to remove unwanted low frequencies such as rumbling and microphone handling noise.

Enhance has four presets for you to tailor the sound to your voice or your intended. You can select one of the four presets using the drop-down arrow in Vocaster Hub:

- Clean
- Warm
- Bright
- Radio

To use Enhance, either press the  button or, if you have Vocaster Hub open, click the on-screen **Enhance** icon.



Vocaster One

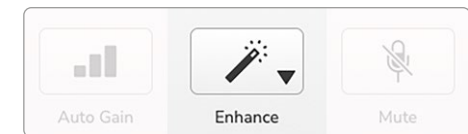

Vocaster Hub

The button lights green when Enhance is on. Press it again to turn Enhance off.





### Listening with headphones

You can connect headphones to the front panel headphone socket marked  to hear what you are recording.

This is a 'default' mix of your microphone and any other audio sources, such as audio from a phone or computer playback (the Loopback channels).



You can adjust the volume of individual audio sources using the mixer in Vocaster Hub.

You can adjust the volume in the headphones with the control on Vocaster One marked : this control does not affect your recording level.

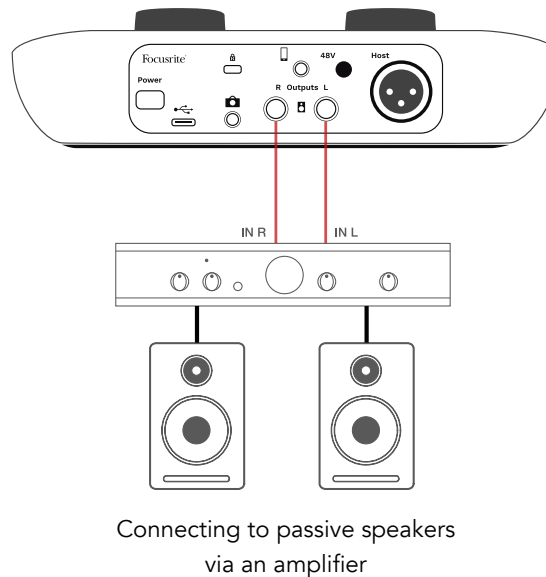
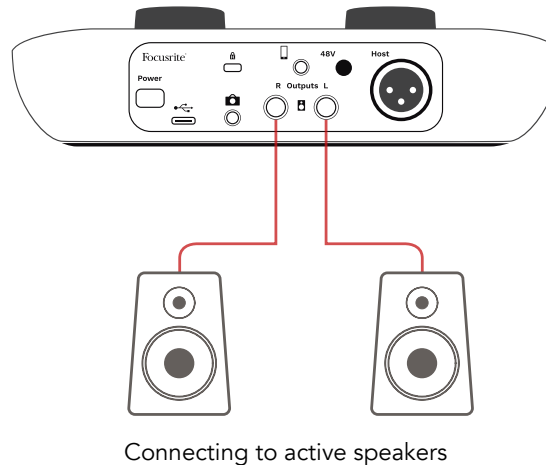
The  Host level controls both the headphones and speaker outputs. When you're using headphones we suggest muting your monitors in Vocaster Hub.



### Listening with speakers

 Use the 1/4" jacks marked Outputs R and L to connect speakers. You can connect powered monitors or an amplifier to these outputs. Speaker volume is controlled by the same  knob used for headphones volume.

The outputs are balanced 1/4" TRS jack sockets and provide line level. Small powered monitors have unbalanced inputs, typically a 3.5 mm jack plug intended for direct connection to a computer. Separate power amplifiers are likely to have phono (RCA) sockets.

You can also mute the speakers using Vocaster Hub software. Click the speaker icon in the top right of Vocaster Hub software to toggle mute on (red) or off (black)



**NOTE:** You can create an audio feedback loop if your speakers are active at the same time as a microphone! We recommend you turn off your speakers while recording podcasts, and use headphones for monitoring.

## EXAMPLES OF USE

### Recording a phone

You can connect a phone to Vocaster One to record a conversation, or to record music from the phone.

The rear panel has a phone connector, marked . This is a 3.5 mm TRRS jack socket, use a 3.5mm TRRS jack cable to connect to the phone's headphone socket, which is normally a 3.5 mm TRRS socket.

A 3.5mm TRS cable will work, but you may not get two-way communication with your phone guest.

If the phone does not have a 3.5 mm headphone port, you can use a 3.5 mm TRRS headphone adaptor.

Vocaster One records audio from a phone in mono.

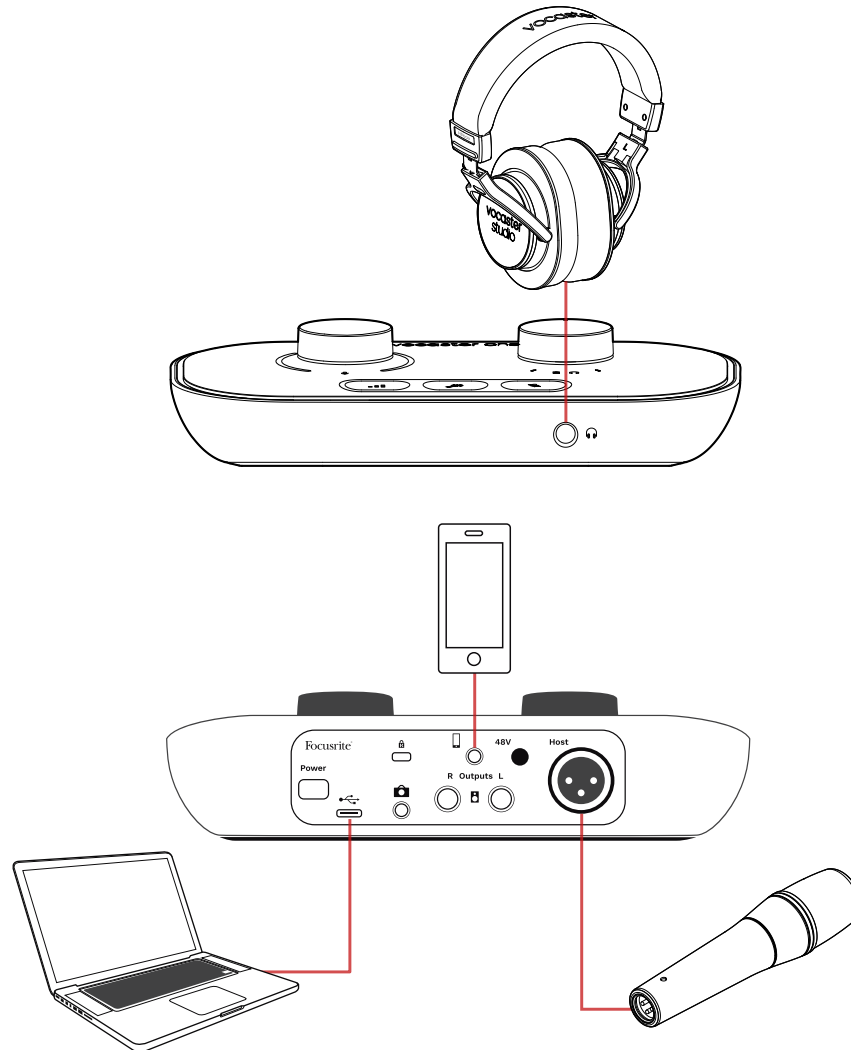

The  connector also feeds Vocaster One's output back to the phone so the person on the phone call can hear the whole podcast mix, but without their own voice. This type of mix is known as 'mix-minus': it ensures the caller will not hear their voice delayed or with echoes.

The signal level to the phone depends on the setting of the input channel sliders in Vocaster Hub's mixer, but is unaffected by the master output slider. The signal fed to the phone is a mono version of the stereo mix, because the phone's input is a mono microphone.

## EXAMPLES OF USE

### Recording to a video camera

If you are working with video, you may want to record your audio into a video camera. Vocaster One has a dedicated output connector for this purpose, the 3.5 mm TRS jack socket on the rear panel marked .

You can connect this output to the audio/mic input on your camera using a 3.5mm jack-to-jack cable.

If your camera input uses a different connector, use a suitable adaptor cable. Ensure you select your camera's external audio source rather than its internal microphone.

The camera output carries the same mix as the USB recording output, and what you hear in your speakers and headphones. You can set the mix and levels going to the camera using the sliders in Vocaster Hub's mixer.

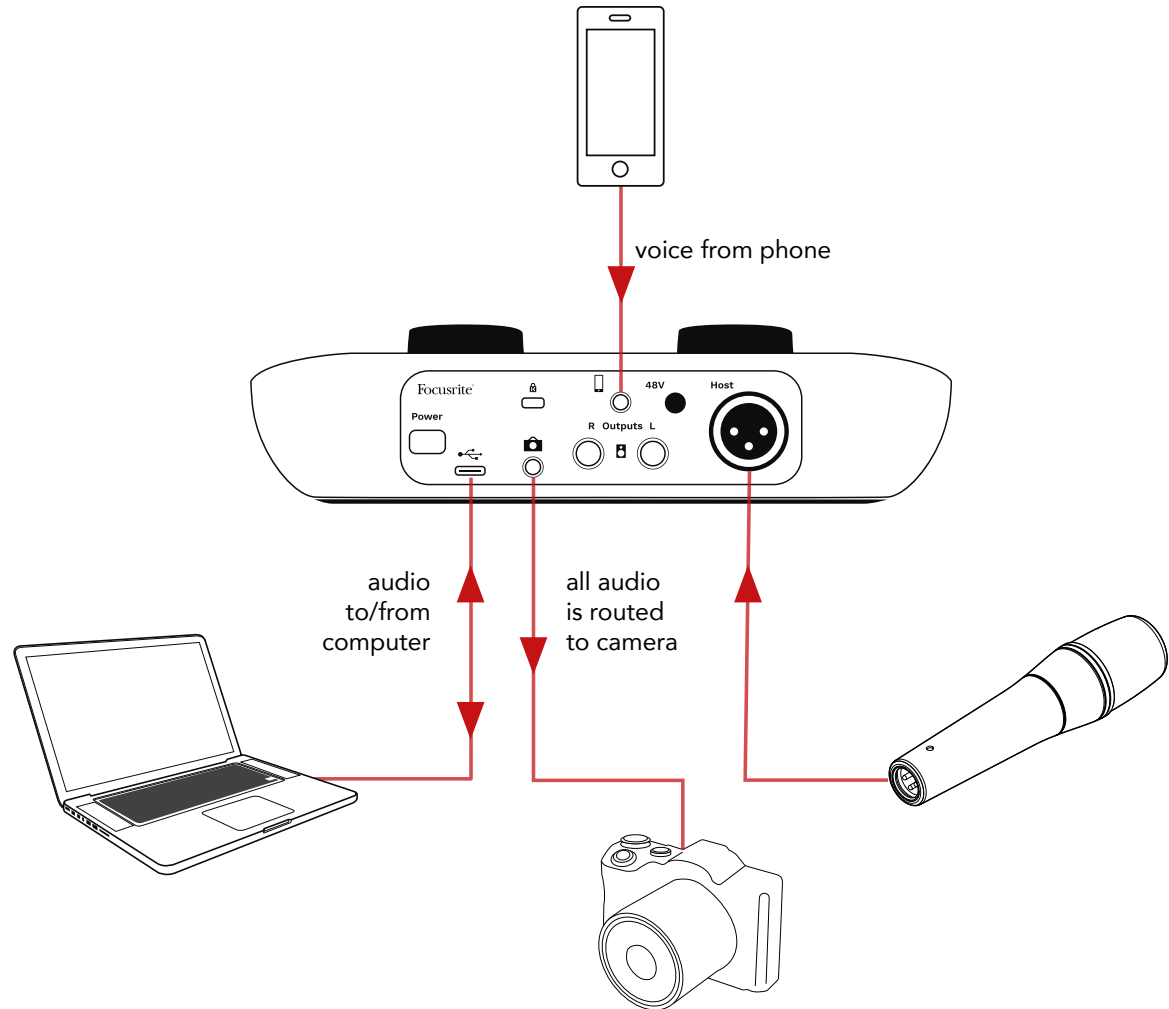

## Vocaster Hub software

As part of the Easy Start registration process, you'll install Vocaster Hub software on your computer. Vocaster Hub gives you access to additional Vocaster One features - most importantly, it lets you balance your voice against any other audio in your mix.

**IMPORTANT:** A separate Vocaster Hub User Guide can be downloaded from the [downloads area](#) of the Focusrite website. This describes the use of Vocaster Hub in full detail. The following section of this User Guide is limited to an overview of the software's primary features.

To open Vocaster Hub: After you install Vocaster Hub on your computer this icon appears in your applications:



Click it to open Vocaster Hub.

If your Vocaster One interface is not connected to your computer and powered on, you will see a Welcome Page.

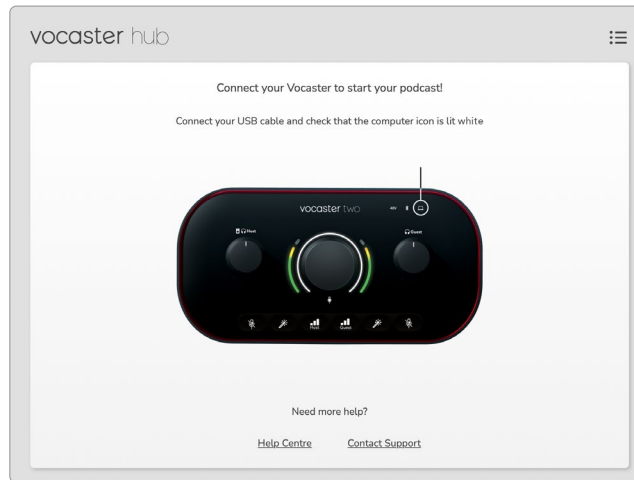

Note the [Help Centre](#) or [Contact Support](#) links. You can always return to this page by turning the interface off. More guidance on using Vocaster One, including tutorial videos, are available at these links.

When you connect the interface and power it on, the  icon lights white to confirm the interface is communicating with your computer, and you'll see Vocaster Hub's Control Page:

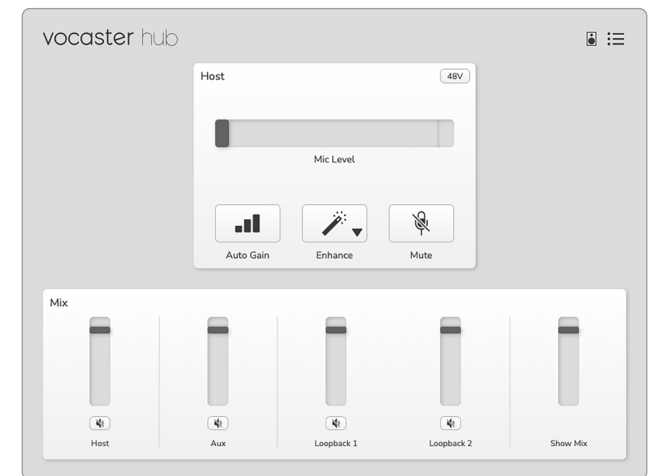

If the  icon lights red, it shows Vocaster One has not been able to communicate with your computer, and you should check the cable is plugged in correctly.

## Controlling the microphone

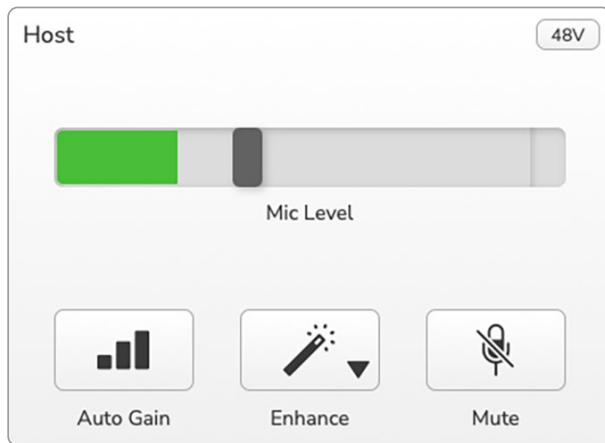

The Host Input panel is where you adjust Vocaster One's microphone channel:



The **Mic Level** display is both a level meter and a level control. Click and drag the grey bar to adjust the gain. This control duplicates the rotary gain knob on the interface, and you can adjust the gain with either control. The colour bar shows the microphone signal level, and again, this duplicates the signal level halo display on the interface.

The bar should remain green most of the time, with amber showing only on the loudest 'peaks'. If it goes red, the gain is set too high.

Below the meter/level display are three buttons which duplicate those on the interface top panel:

- **Auto Gain**  – click this to start the Auto Gain function; speak normally into the microphone for 10 seconds to calibrate the gain setting.
- **Enhance**  – click on this to activate the Enhance feature; the button shows green. Click again to deactivate.
- **Mute**  – click on this to mute the microphone; the button and the level display show red when mute is active. Click again to unmute.



## Controlling your mix

The **Mix** section of Vocaster Hub allows you to balance the audio inputs and computer outputs making up your Show Mix.

Like the Mic Level control, the 'sliders' are both meters and level control. The sliders affect the headphone/speaker mixes and Show Mix recording but don't affect the level of each channel into your software. The channels of the mixer are (left to right):

- **Host** (mono) – this is Vocaster One's Host microphone.
- **Aux** (mono) – use this when you have connected a phone to the rear panel  connector. It adjusts the audio level being received from the phone.
- **Loopback 1** and **Loopback 2** (stereo)– these control the level of two audio sources within your computer: these could be feeds from the internet, pre-recorded files, or other sources. In the image below Loopback 1 is 'clipping' so the source level needs turning down to stop the red clip bar appearing.
- **Show Mix** (stereo) – this shows and controls the overall output level of the mixer.

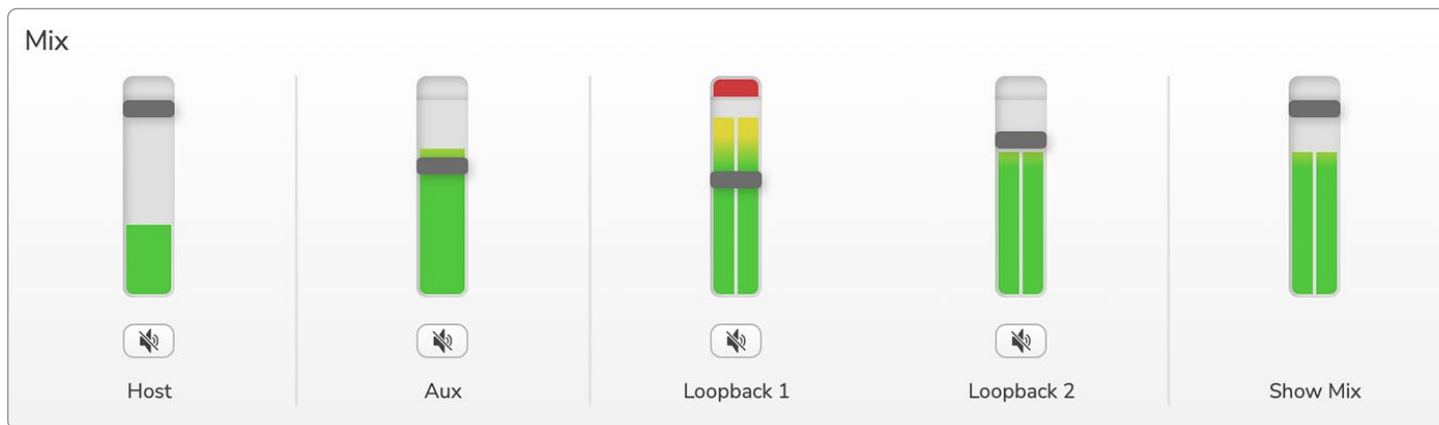

On the Loopback 1 channel the red part of the meter is the 'Clip Indicator'. This shows you the **source** is too loud and may distort in your recording. Bluetooth and Loopback are an exception and may show as clipped more often.

Turn down the track's source, **not the slider in the mixer**. If the Show Mix clips, turn down the tracks in the mixer.





### Recording sounds from your computer

Vocaster's Loopback feature lets you record audio sources from within your computer (e.g., the audio output from a web browser). There are two stereo Loopback sliders on the mixer; these use Vocaster One's 'virtual' inputs. The virtual inputs don't have connectors on the interface, but you can record them in your DAW in the same way as any other input.

You can feed each Loopback input from a different software application. Which application you use with each Loopback input is configured in the application's output settings. If you're a Mac User and wish to use both Loopback inputs, we recommend you read [this support article](#).

- Loopback 1 – this input gets its signal from software with its output set to Playback 1-2, or software that doesn't support output routing. The software you can use with Loopback 1 includes:
  - Internet browsers
  - Music playback software such as Spotify or Apple Music.
  - Video call and conference software.
- Loopback 2 – this input gets its signal from audio software with its output routing set to Playback 3-4. You can configure this in the software's audio settings, but not all software allows output routing selection, so please check your software's user guide for this feature. Software with the ability to feed audio to Loopback 2 includes:
  - Other recording or playback software you're using.
  - VOIP and video conferencing applications.



### Example of Loopback usage

You might want to use both Loopback inputs when you're recording a show but need independent recordings of other software sounds to mix later. For example, in your show, you want to record your conversation with a guest in a video call in addition to including a sound or jingle playback from another audio playback software.

Your video call software (e.g., Zoom), routes its output to Playback 1-2 by default. This appears as Loopback 1 in the mixer. You can then route the output of your playback software to Playback 3-4, which becomes available as Loopback 2.

In your recording software you can now have separate tracks for recording:

- Loopback 1 appears on your DAW channels 7 and 8
- Loopback 2 appears on your DAW channels 9 and 10

For all further details, please refer to the Vocaster Hub User Guide.

### Recording Tracks into Software

Depending on which recording software you use, you can pick from up to ten channels to record from, to separate tracks.

The ten channels you'll see are:

DAW Input Number	Vocaster Input	Use
1	Video Call L	A mix of all inputs excluding Loopback, this is a mix-minus so a video call guest can hear your whole show without hearing (minus) themselves.
2	Video Call R	
3	Show Mix L	A stereo mix of all the inputs to record your whole show.
4	Show Mix R	
5	Host Microphone	The Host microphone input.
6	Aux	A mono feed from a device connected to the phone input on Vocaster.
7	Loopback 1 L	Signal from software fed from software playback 1-2.
8	Loopback 1 R	
9	Loopback 2 L	Signal from software fed from software playback 3-4.
10	Loopback 2 R	

# Hardware Features

## Top Panel



The large rotary control adjusts the gain for the microphone input.

The gain control has two 'halo' LED arcs. These have several functions.

- In normal operation they confirm microphone level: green means normal operation, amber shows the signal is close to clipping, and red shows digital clipping, which should always be avoided.
- Following an Auto Gain calibration, the arcs illuminate either green or red to show a successful or unsuccessful operation (respectively).
- The left-hand arc illuminates white while microphone gain is being adjusted, to show the current gain setting
- Both arcs pulse red when the microphone is muted

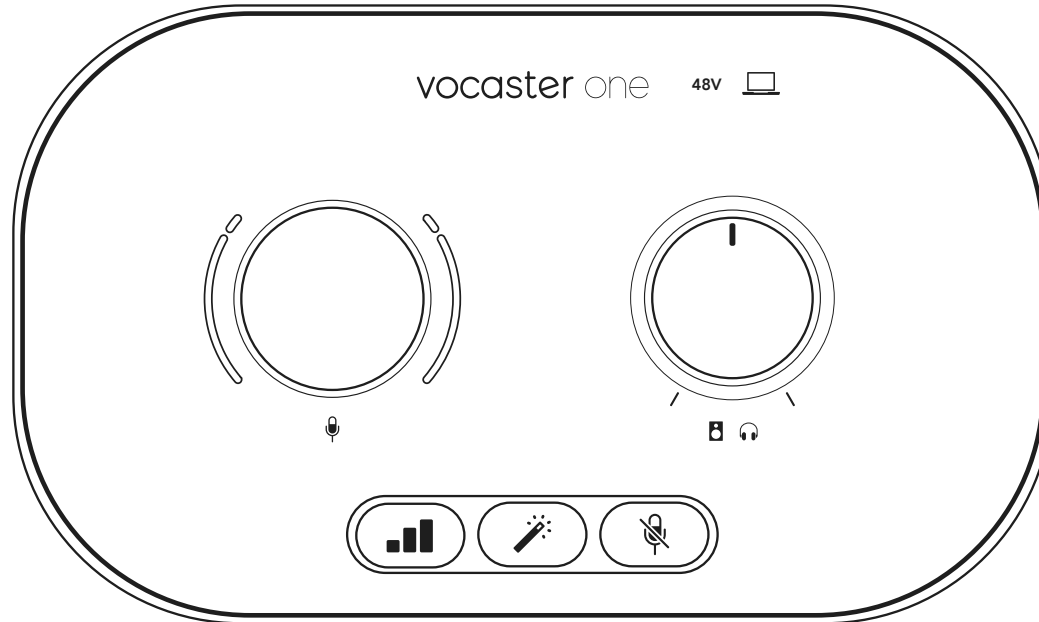

### Buttons



Press to start the **Auto Gain** function: speak normally into your microphone for 10 seconds to set the microphone gain. The LED pulses amber during the process.



**Enhance button.** Press to activate/deactivate the Enhance function. LED illuminates green when Enhance is active.



**Microphone mute button.** Press to mute or unmute the microphone channel. LED illuminates red when muting is active.

## Indicators



An LED which illuminates white when the interface has established communication with the computer it is connected to, and red if communication fails.

## 48V

Illuminates red when 48V phantom power is active.



**Monitor output level control** - sets the output level at both the front panel headphone output and the rear panel speaker outputs.

## Rear Panel

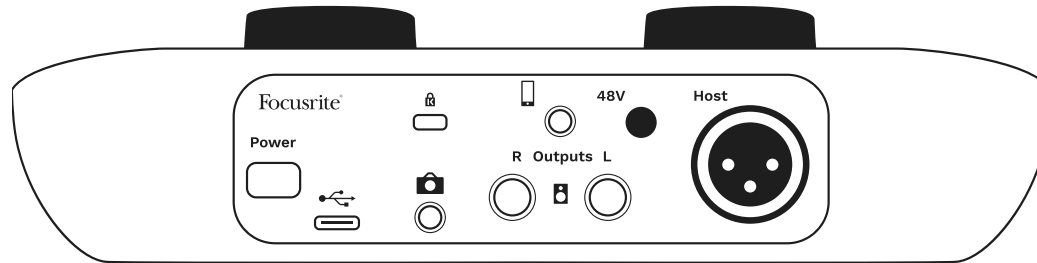

### Power

Press to turn Vocaster One on and off.



USB 3.0 port – Type C connector; connect to your laptop or computer with the USB cable supplied.



Kensington security slot – make your Vocaster One secure using a Kensington lock.



3.5 mm TRS jack socket for connecting Vocaster One to the external audio input of a video camera.



3.5 mm TRRS jack socket for a wired connection to a compatible phone.



**Outputs L and R** – for connecting to monitor loudspeakers. Two 1/4' TRS jack sockets; electronically balanced. Either 1/4' TRS (balanced connection) or TS (unbalanced connection) jack plugs can be used.

### 48V

Phantom power switch for microphone input – press to enable 48V phantom power at the XLR socket.

### Host

XLR socket for connecting a microphone

#### On the front:



Headphones output socket. Connect your headphones here. If your headphones use a 3.5mm jack then you need to use a 3.5mm to 1/4' jack adaptor.

# Specifications

## Performance Specifications

These specifications allow you to compare your Vocaster with other devices and make sure they'll work together. If you're not familiar with these specifications, don't worry you don't need to know this information to use your Vocaster with most devices.

### Sample Rate

48 kHz

### USB

Version	USB 3.0
Maximum Current	0.8A
Maximum Voltage	5V
Maximum Power	4W

### Microphone Input

Impedance	3K $\Omega$
Maximum Input Level	+12.5dBu @ minimum gain
Gain Range	70dB
THD+N (@ -1dBFS)	$\leq$ -94dB
Frequency Response (20Hz @ minimum gain)	20Hz - 20KHz +0, -0.5 dB

### Phone Input

Impedance	18K $\Omega$
THD+N (@ -1dBFS)	$\leq$ -94dB
Maximum Input Level	+1dBu
Frequency Response	20Hz - 20KHz +0, -0.5

### Phone Output

Impedance	220 $\Omega$
Maximum Output Level	-26dBu
THD+N	-73dB
Frequency Response	20Hz - 20KHz +0dB, -0.5dB

### Line Outputs

Impedance	440 $\Omega$
Maximum Output Level	+14dBu
THD+N	$\leq$ -96dB
Frequency Response	20Hz - 2kHz $\pm$ 0.15dB

### Headphone Output

Impedance	5 $\Omega$
Maximum Output Level @ 0dBFS	+6.5dBu
Maximum Power (mW)	8.5mW into 270 $\Omega$ 28mW into 33 $\Omega$
THD+N	-96dB unloaded
Frequency Response	20Hz - 20KHz, $\pm$ 0.5dB

### Camera Output

Impedance	220 $\Omega$
Maximum Output Level	-24.5dBu
THD+N (Max Output, -1dBFS, 22Hz - 22kHz)	-73dB
Frequency Response	20Hz - 20KHz $\pm$ 0.2dB

## SPECIFICATIONS

### Physical And Electrical Characteristics

#### Other Audio I/O

Camera output	3.5 mm TRS jack on rear panel
Phone input and output	3.5 mm TRRS jack on rear panel
Loopback inputs	Two (stereo) via Vocaster Hub

#### Microphone Input

Connector	Balanced, via female XLR on rear panel
Phantom power	48V, rear panel switch

#### Weight and Dimensions

Weight	348g
Height	50mm
Width	195mm
Depth	113mm

#### Analogue Outputs

Main outputs	Balanced, 2 x ¼" TRS jacks
Stereo headphone output	¼" TRS jack on front panel
Output level control (main and headphone)	On top panel







### Troubleshooting

For all troubleshooting queries, please visit the Focusrite Help Centre at [support.focusrite.com](https://support.focusrite.com)

### Copyright and Legal Notices

Focusrite is a registered trademark and Vocaster is a trademark of Focusrite Audio Engineering Limited.

All other trademarks and trade names are the property of their respective owners.  
2022 © Focusrite Audio Engineering Limited.  
All rights reserved.

### Credits

Focusrite would like to thank the following members of the Vocaster team for their hard work to bring you this product.

Adrien Fauconnet, Alex Middleton-Dalby, Alex Wood, Andre Cerqueira, Anthony Nicholls, Ben Bates, Ben Cook, Ben Dandy, Bran Searle, Ben Cochrane, Chris Graves, Dan Weston, Daniel Clarke, Daniel Hughley, David Marston, Derek Orr, Ed Fry, Eddie Judd, Emma Davies, Harry Morley, Ian Hadaway, Jack Cole, Jake Wignall, James Johnson, James Otter, James Surgenor, Jason Cheung, Jed Fulwell, Jessica Chambers, Joe Deller, Kai Van Dongen, Linus Reitmayr, Luke Matthews, Martin Dewhirst, Mary Browning, Michail Fragkiadakis, Mike Richardson, Mukesh Lavingia, Orla Haigh, Rob Stevenson, Ryan Gray, Seraphin Gnehm, Steve Bush, Stefan Archer, Stratis Sofianos, Tom Cartwright, Vidur Dahiya, Vincenzo Di Cosmo and Wade Dawson