

Scarlett 18i20

User Guide

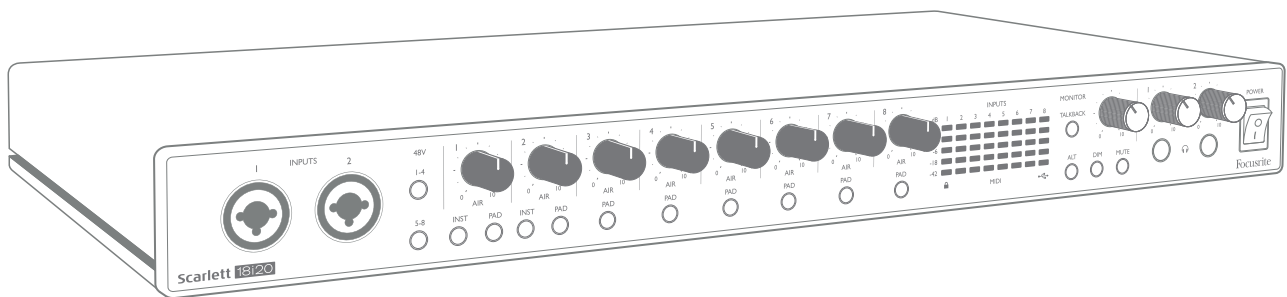

Focusrite®

focusrite.com

TABLE OF CONTENTS

OVERVIEW	3
Introduction	3
Features	3
Box Contents	4
System requirements	4
Rack mounting the Scarlett 18i20	5
GETTING STARTED	6
Quick Start Tool	6
Mac users only:	6
Windows only:	8
All users:	10
Manual Registration	10
HARDWARE FEATURES	11
Front Panel	11
Rear Panel	13
Connecting your Scarlett 18i20	14
Power	14
USB	14
Audio Setup in your DAW	15
Loopback Inputs	16
Examples of Usage	17
Recording a band	17
Low Latency Monitoring	18
Connecting Scarlett 18i20 to loudspeakers	19
Using the ADAT connection	23
Using the Scarlett 18i20 as a stand-alone mixer	24
Using the Scarlett 18i20 as a stand-alone preamp	24
FOCUSRITE CONTROL	25
Channel Listing tables	26
Digital I/O Modes	26
SPECIFICATIONS	31
Performance Specifications	31
Physical and Electrical Characteristics	33
TROUBLESHOOTING	35
COPYRIGHT AND LEGAL NOTICES	35

OVERVIEW

Introduction

Thank you for purchasing this Third Generation Scarlett 18i20, one of the family of Focusrite professional computer interfaces incorporating high quality Focusrite analogue preamps. In conjunction with the unit's accompanying software application, Focusrite Control, you now have a compact yet highly versatile solution for routing high quality audio to and from your computer. You can also use the Scarlett 18i20 as a "stand-alone" interface to any other type of recording device, once you have configured it using Focusrite Control.

Focusrite Control, and several other exciting and useful software applications, can be downloaded free of charge once you have registered your product. Note that a separate Focusrite Control User Guide is also available; we strongly recommend you download this as well.

In developing the Third Generation series of Scarlett interfaces, we have made further improvements to both performance and features. Audio specifications have been upgraded throughout the unit to give you greater dynamic range and even lower noise and distortion; additionally, the mic preamps now accept higher input levels. An important enhancement is the inclusion of Focusrite's AIR function. Individually selectable on each channel, AIR subtly modifies the preamp's frequency response to model the sonic characteristics of our classic transformer-based ISA microphone preamps. When recording with good quality microphones, you will notice an enhanced clarity and definition in the important mid to high frequency range, just where it is most needed for vocals and many acoustic instruments. Third Generation Scarlett interfaces are class compliant on macOS: this means they are plug-and-play, so no need to install a driver if you are a Mac user.

Your Third Generation Scarlett interface is compatible with our Focusrite Control software application: this lets you control various hardware features, set up monitor mixes and configure routings. There is a Focusrite Control installer for both Mac and Windows platforms, and no driver is required for Macs. The Windows version of the installer contains the driver, so in either case, you only need to install Focusrite Control to get up and running.

This User Guide provides a detailed explanation of the hardware to help you achieve a thorough understanding of the product's operational features. We recommend you take the time to read through the User Guide, whether you're new to computer-based recording or a more experienced user, so you are fully aware of all the possibilities the Scarlett 18i20 and accompanying software have to offer. If the main User Guide sections do not provide the information you need, be sure to consult support.focusrite.com, which contains a comprehensive collection of answers to common technical support queries.

Features

The Scarlett 18i20 audio interface caters for a total of 18 inputs and 20 outputs, and provides the means to connect microphones, musical instruments, line level audio signals and digital audio signals in both ADAT and S/PDIF formats to a computer running compatible versions of macOS or Windows via one of the computer's USB ports. In the Third Generation, the optical ADAT ports also support "Dual ADAT" operation (S/MUX II), which provide 8 channels of audio at 88.2/96 kHz as well as at 44.1/48 kHz.

The signals at the physical inputs can be routed to your audio recording software / digital audio workstation (referred to throughout this user guide as the "DAW") at up to 24-bit, 192 kHz resolution; similarly, the DAW's monitor or recorded output signals can be configured to appear at the unit's physical outputs.

The outputs can be connected to amplifiers and speakers, powered monitors, headphones, an audio mixer or any other analogue or digital audio equipment you wish to use. Although all inputs and outputs on the Scarlett 18i20 are routed directly to and from your DAW for recording and playback, you can configure the routing within your DAW To meet your precise needs.

The accompanying software application, Focusrite Control, provides further routing and monitoring options, as well as the ability to control global hardware settings such as sample rate and synchronisation.

Two new features have been added to the Third Generation 18i20: talkback and secondary monitor speaker switching. The Talkback function uses the built-in mic to let you speak to the musicians through their headphones, though the talkback signal may alternatively be routed to any other combination of outputs. The ALT function lets you connect a second pair of monitor loudspeakers to Line Outputs 3 and 4 and switch between the pairs to reference your mix on a different set of speakers. Both functions can be activated from the front panel but they can also be configured and selected on-screen from Focusrite Control.

All inputs on the Scarlett 18i20 are routed directly to your DAW software for recording, but Focusrite Control also allows you to route these signals internally within the device to the outputs so you can monitor the audio signals with ultra-low latency - before they arrive at your DAW, should you need to do so.

The Scarlett 18i20 also has connectors for sending and receiving MIDI data, and for transmitting word clock to ensure synchronisation with other items of digital audio equipment.

Box Contents

Along with your Scarlett 18i20 you should have:

- IEC mains cable (with plug appropriate for your territory)
- USB cable, Type 'A' to Type 'C'
- Getting Started Information (printed inside the box lid)
- Important Safety Information
- Set of rack ears (for mounting the 18i20 in a 19" rack)

System requirements

The easiest way to check your computer's operating system (OS) is compatible with your Scarlett is to use our Help Centre's compatibility articles:

support.focusrite.com/hc/categories/200693655

As new OS versions become available over time, you can continue to check for further compatibility information by searching our Help Centre at support.focusrite.com.

Rack mounting the Scarlett 18i20

You can mount the Scarlett 18i20 in a standard 19" equipment rack. To do this, you first need to fit the rack ears supplied with the device.

To fit the rack ears:

- Remove the rubber "Focusrite" inserts from the sides of the Scarlett 18i20. This will reveal three tapped fixing holes:

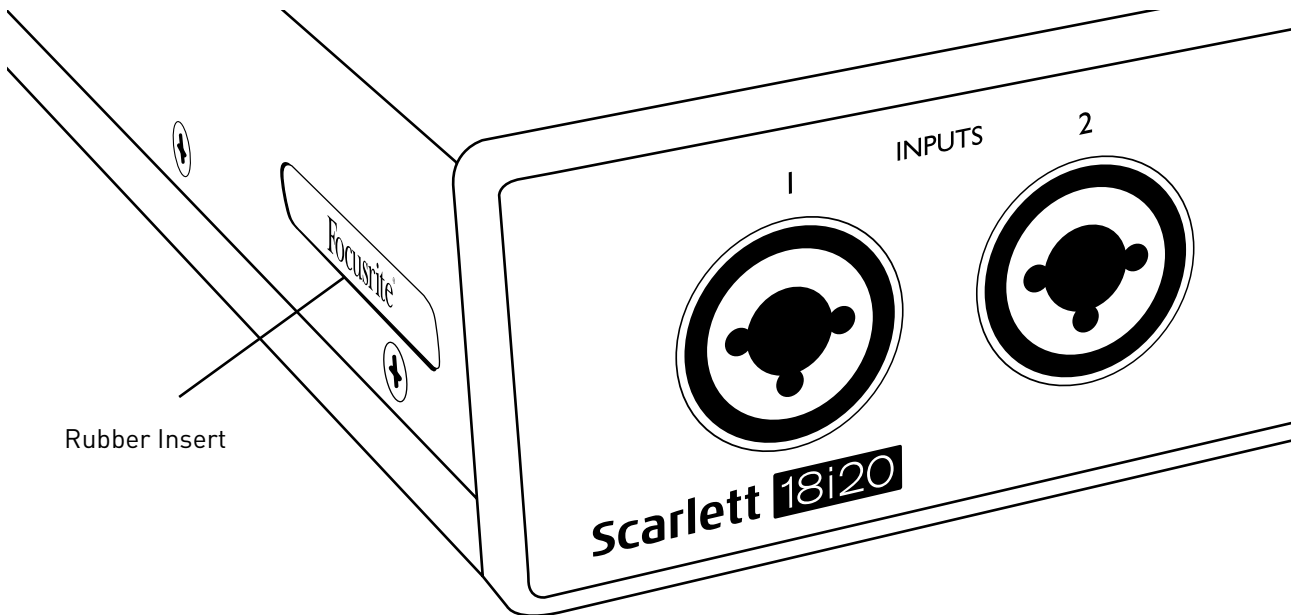

- Fix the rack ears to the sides of the chassis using the three countersunk M4 screws supplied:

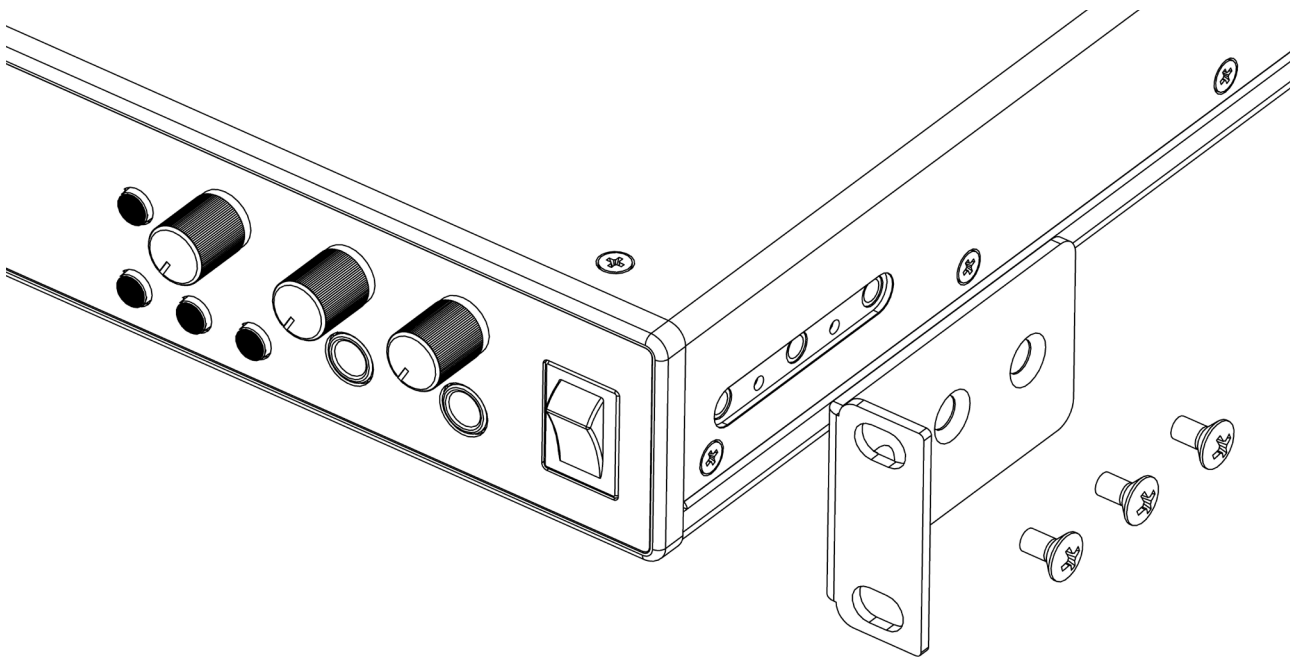

GETTING STARTED

With the Third Generation, Scarlett interfaces introduce a new, faster way of getting up and running, using the Scarlett Quick Start tool. All you need to do is connect your Scarlett 18i20 to your computer. Once connected, you will see the device is recognised by your PC or Mac and the Quick Start tool will guide you through the process from there.

IMPORTANT: The Scarlett 18i20 has a single USB 2.0 Type C port (on the rear panel): connect it to your computer using the USB cable provided. Note that Scarlett 18i20 is a USB 2.0 device, and thus the USB connection requires a USB 2.0+ compliant port on your computer.

Your computer will initially treat your Scarlett as a Mass Storage Device (MSD), and during its first connection, the Scarlett will be in “Easy Start mode”

Quick Start Tool

We have tried to make registering your Scarlett 18i20 as simple as possible. The steps are designed to be self explanatory, but we have described each step below, so you can see how they should appear on either a PC or a Mac.

Mac users only:

On connecting your Scarlett 18i20 to your Mac, a Scarlett icon will appear on the desktop:



Double-click on the icon to open the Finder window shown on the following page.

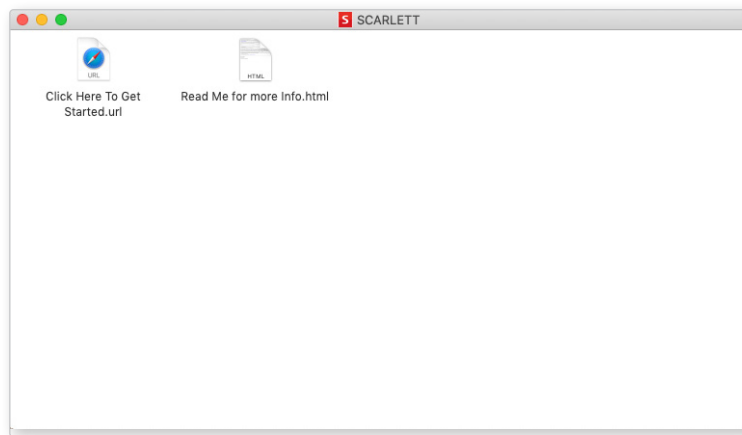

Double-click on the “Click Here to Get Started.url” icon. This will redirect you to the Focusrite website, where we recommend you register your device:



Click on “Let’s get you started”, and you’ll see a form which will be partly prefilled for you automatically. When you submit the form, you’ll see options to go straight to the downloads to get the software for your Scarlett, or to follow a step by step setup guide based on how you want to use your Scarlett.

Once you have installed the Focusrite Control software to set up and configure your interface, the Scarlett will be switched out of Easy Start mode so it no longer appears as a Mass Storage Device when connected to your computer.

Your OS should switch the computer’s default audio inputs and outputs to the Scarlett. To verify this, go to **System Preferences > Sound**, and ensure the input and output are set to **Scarlett 18i20**.

For detailed setup options on a Mac, open **Applications > Utilities > Audio MIDI Setup**.

Windows only:

On connecting your Scarlett 18i20 to your PC, a Scarlett icon will appear on the desktop:

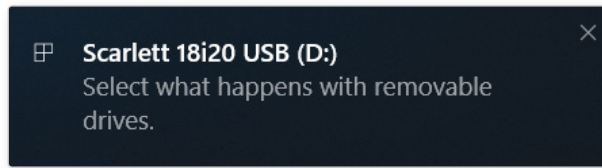

[Note that the drive letter may be something other than D:, depending on other devices connected to your PC].

Double-click on the pop-up message to open the dialogue box shown below:

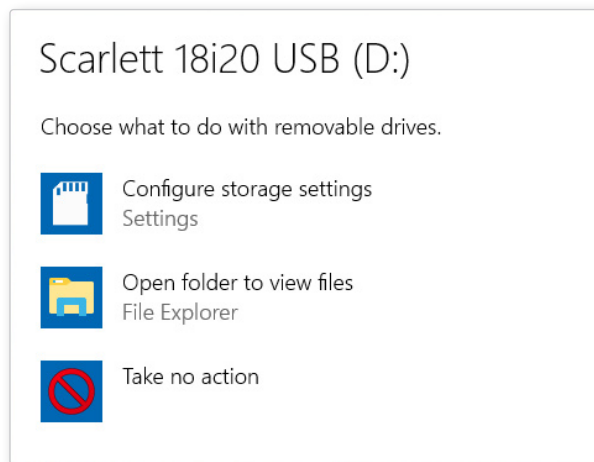

Double-click on “Open folder to view files”: this will open an Explorer window:

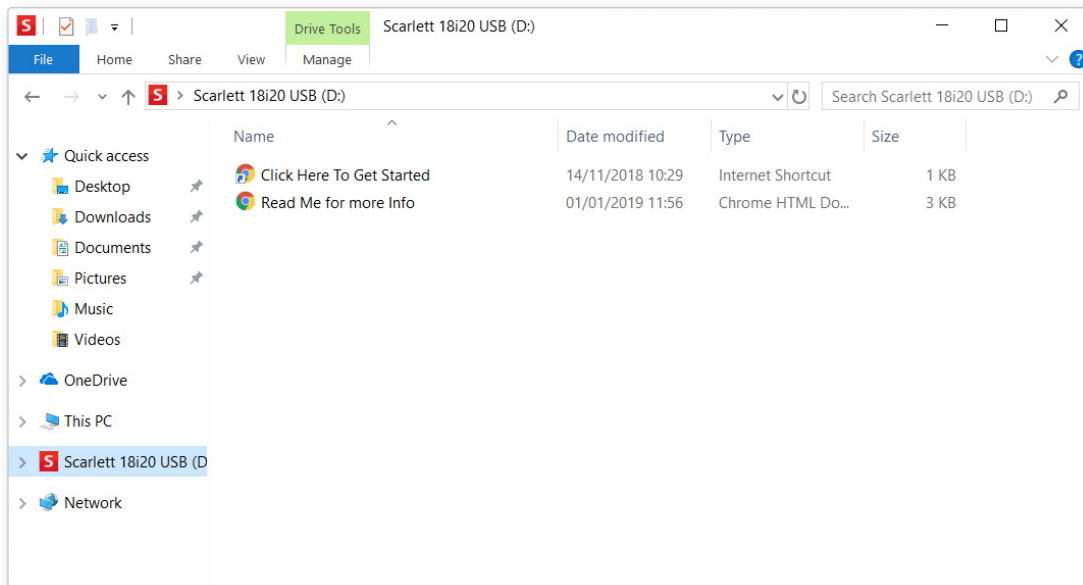

Double-click “Click Here to Get Started”. This will redirect you to the Focusrite website, where we recommend you register your device:



Click on “Let’s get you started”, and you’ll see a form which will be partly prefilled for you automatically. When you submit the form, you’ll see options to go straight to the downloads to get the software for your Scarlett, or to follow a step by step setup guide based on how you want to use your Scarlett.

Once you have installed the Focusrite Control software to set up and configure your interface, the Scarlett will be switched out of Easy Start mode so it no longer appears as a Mass Storage Device when connected to your computer.

Your OS should switch the computer’s default audio inputs and outputs to be the Scarlett . To verify this, right click on the Sound icon on the taskbar and select **Sound Settings**, and set the Scarlett as the Input and Output Device.

All users:

Note that a second file - “More Info & FAQs” - is also available during the initial set-up process. This file contains some additional information about the Focusrite Quick Start tool which you may find helpful if you have any issues with the procedure.

Once registered, you will have immediate access to the following resources:

- Focusrite Control (Mac and Windows versions available) - see NOTE below
- Multi-language User Guides

You can find the licence codes and links for the optional bundled software in your Focusrite account. To find out what bundled software is included with Scarlett 3rd generation, please visit our website:

focusrite.com/scarlett

NOTE: Installing Focusrite Control will also install the correct driver for your device. Focusrite Control is available to download at any time, even without registering: see “Manual Registration” below.

Manual Registration

If you decide to register your Scarlet at a later date you can do so at:

customer.focusrite.com/register

You will need to enter the Serial Number manually: this number can be found on the base of the interface itself, and also on the barcode label on the side of the box.

We recommend you download and install our Focusrite Control application, as this will disable Easy Start mode and unlock the full potential of the interface. Initially, when in Easy Start mode, the interface will function at sample rates up to 48 kHz and the MIDI I/O is disabled. Once Focusrite Control is installed on your computer, you can work at sample rates up to 192 kHz.

If you decide not to download and install Focusrite Control immediately, it can be downloaded at any time from:

customer.focusrite.com/support/downloads

To force your Scarlett out of Easy Start mode without first registering it, connect it to your computer and press and hold the 1-4 **48V** button for five seconds. This will ensure your Scarlett has full functionality. Please bear in mind that should you wish to register your Scarlett after taking this action, you will need to do so manually, as explained above..

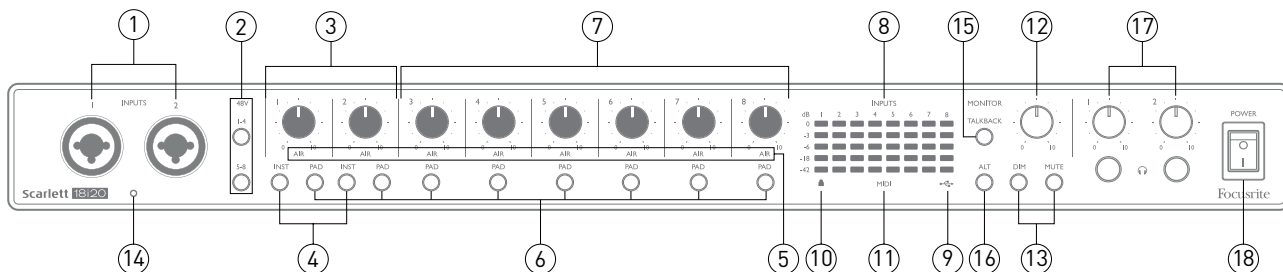

HARDWARE FEATURES

Front Panel





The front panel includes all the input gain and monitoring controls as well as two of the input connectors for Mic, Line and Instrument signals.

1. **Inputs 1 and 2** – “Combo” input sockets - connect microphones, instruments (e.g., guitar), or line level signals here. Combo sockets accept both XLR and ¼” (6.35 mm) jacks. Microphones connect using XLR plugs: instruments and line level signals connect via ¼” (6.35 mm) jack plugs of either TS or TRS type. The preamp gain is appropriate for microphones when an XLR plug is inserted, and for higher level signals when a jack plug is inserted. Do not connect anything other than a microphone - e.g., the output of a sound module or FX unit - via an XLR plug, as the signal level will overload the preamp, resulting in distortion and if phantom power is enabled, you may damage your equipment.
2. **48V** – two switches (**1-4, 5-8**) enabling 48 V phantom power at the XLR contacts of the Combo connectors for mic inputs 1-4 and 5-8 respectively. (Note that inputs 3 to 8 are on the rear panel.) The switches each have an associated red LED indicating phantom power is selected.
3. **Gain 1 & 2** – adjust the input gain for the signals at Inputs 1 and 2 respectively.
4. **INST** – two switches changing the input configuration for the jack contacts at Inputs 1 and 2. When INST is selected, the gain range and input impedance are altered (relative to LINE), and the input is made unbalanced. This optimises it for the direct connection of instruments (via a 2-pole (TS) jack plug). When INST is off, the inputs are suitable for the connection of line level signals. Line level signals may be connected either in balanced form via a 3-pole (TRS) jack or unbalanced via a 2-pole (TS) jack. ‘INST’ illuminates red when Instrument mode is selected. INST may also be selected from Focusrite Control.
5. **AIR** – eight yellow LEDs indicating selection of AIR mode for each channel. AIR mode, selected from Focusrite Control, modifies the frequency response of the input stage to model the classic, transformer-based Focusrite ISA microphone preamps.
6. **PAD** – eight switches to select the PAD function for each channel. PAD decreases the signal level going to your DAW by 10 dB; use when the input source has a particularly high level. ‘PAD’ illuminates red when active. PAD may also be selected from Focusrite Control.
7. **Gain 3 to 8** – adjust the input gain for the signals at Inputs 3 to 8 respectively. (Note that the connectors for these inputs are on the rear panel.)

8. Input meters – eight 5-segment LED bargraph meters indicating the signal levels of the eight analogue input signals. The meters show signal level after the input gain stage, and thus their indication is affected by the gain controls. The LEDs illuminate at -42 (green, “signal present”), -18 (green), -6 (green), -3 (yellow) and 0 dBFS (red). A level of 0 dBFS results in digital clipping, and should always be avoided.
9.  USB active LED – a green LED illuminates when the Scarlett is connected and recognised by your computer.
10.  Locked – a green LED which confirms clock synchronisation, either to the Scarlett 18i20’s internal clock or to an external digital input.
11. **MIDI** LED – green LED, illuminates when MIDI data is received at the **MIDI IN** port.
12. **MONITOR** – main monitor output level control: this will normally control the level at the main monitor outputs on the rear panel, but can be configured in Focusrite Control to adjust the level at any of the unit’s ten analogue outputs.
13. **DIM** and **MUTE** – two switches to control the 18i20’s monitor outputs; **DIM** reduces the output levels by 18 dB, while **MUTE** turns the outputs off. By default, these switches affect the **MAIN** monitor outputs 1 and 2, but in Focusrite Control you can configure them to control any of the analogue outputs. The switches each have an associated LED (DIM: yellow, MUTE: red) indicating the function is selected. DIM and MUTE may also be selected from Focusrite Control.
14. Talkback microphone
15. **TALKBACK** – press and hold this button to activate talkback. When active, ‘TALKBACK’ illuminates green, and the talkback mic [14] may be routed to the 18i20’s various outputs. By default, talkback routes to the two headphone outputs [17], but the routing may be configured in Focusrite Control to feed any combination of outputs. This button is ‘momentary’ – talkback is only active while it is pressed. Talkback may also be activated, momentary or latching, from Focusrite Control.
16. **ALT** – when the ALT function is enabled in Focusrite Control, pressing this button diverts the main monitor mix from **MAIN LINE OUTPUTS 1** and **2** to **ALT LINE OUTPUTS 3** and **4**. Connect a pair of secondary monitor speakers to the **ALT** outputs, and select **ALT** to switch between your main monitors and the secondary pair. ‘ALT’ illuminates green when selected. This function may also be selected from Focusrite Control. (Note that when ALT is enabled, the line outputs not in use are muted: e.g., to use Line Outputs 3 and 4 for another purpose, first unmute them in Focusrite Control.)
17.  Headphone volume **1** and **2** – connect one or two pairs of headphones at the two ¼” (6.25 mm) TRS jack sockets below the controls. The headphone outputs always carry the signals currently routed to analogue outputs 7/8 and 9/10 (as stereo pairs) in Focusrite Control.
18. **POWER** – AC power switch.

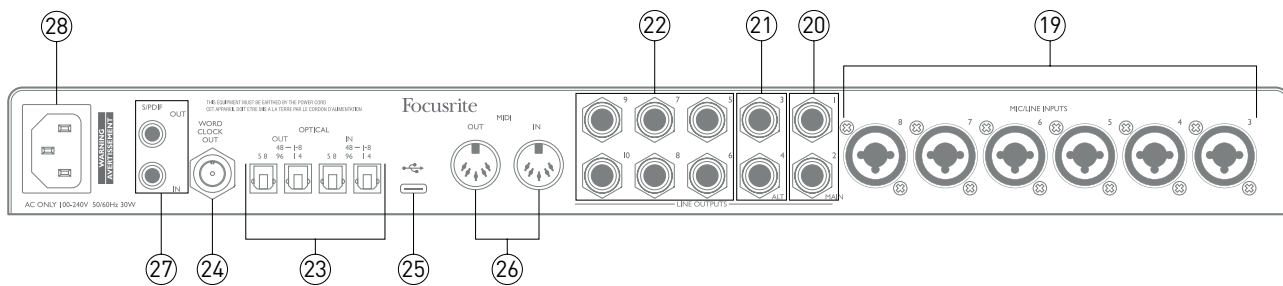
Rear Panel



19. **MIC/LINE INPUTS 3 to 8** – Combo type input sockets - connect further microphones or line level signals via XLR or ¼” (6.35 mm) jacks as appropriate. Either ¼” TRS (balanced) or TS (unbalanced) jack plugs can be used for line level signals.
20. **LINE OUTPUTS 1 and 2 (MAIN)** – two balanced analogue line outputs on ¼” (6.35 mm) jack sockets; use TRS jacks for a balanced connection or TS jacks for unbalanced. We recommend the use of balanced connections wherever possible, to minimise grounding and hum problems. These will generally be used for driving the main L and R speakers of your monitoring system. However, the signals at the outputs may be defined in Focusrite Control
21. **LINE OUTPUTS 3 and 4 (ALT)** – connect a secondary pair of monitor speakers here To use the 18i20’s ALT function. The outputs are electrically identical to Line Outputs 1 and 2. The signals at the outputs may be defined in Focusrite Control.
22. **LINE OUTPUTS 5 to 10** – six further line outputs with identical electrical characteristics to Line Outputs 1 to 4. The signals available at these outputs are defined in Focusrite Control, and can be used for driving the additional speakers in a multichannel monitoring system, or to drive outboard FX processors.
23. **OPTICAL IN and OUT** – four TOSLINK connectors for handling eight channels of digital audio in ADAT format at either 44.1/48 kHz or 88.2/96 kHz sample rates. At 44.1/48 kHz sample rate, only the right-hand port of each pair is used; at 88.2/96 kHz sample rate, both ports are used, with the right-hand port carrying ADAT Channels 1-4 and the left-hand port carrying ADAT Channels 5-8. (Note that the optical input and output are disabled when sample rates of 176.4/192 kHz are in use.) The left-hand port of each pair (**IN** and **OUT**) may be configured to receive and transmit a two-channel S/PDIF signal from/to an external source equipped with optical S/PDIF I/O: this option is selected from Focusrite Control. Please refer to the Channel Listing tables in the Appendix section for more details.
24. **WORD CLOCK OUT** – a BNC connector carrying the Scarlett 18i20’s word clock; this may be used to synchronise other digital audio equipment forming part of the recording system. The source of sample clock synchronisation used by the Scarlett 18i20 is selected from Focusrite Control.
25.  USB 2.0 port – Type C connector; connect the Scarlett 18i20 to your computer with the cable supplied.
26. **MIDI IN and MIDI OUT** – standard 5-pin DIN sockets for connection of external MIDI equipment. The Scarlett 18i20 acts as a MIDI interface, allowing MIDI data to/from your computer to be distributed to additional MIDI devices.
27. **S/PDIF IN and OUT** – two phono (RCA) sockets carrying two-channel digital audio signals into or out of the Scarlett 18i20, in S/PDIF format. Note that S/PDIF inputs and outputs are unavailable at 176.4/192 kHz sample rates. Please refer to the Channel Listing tables in the Appendix section for more details.
28. AC mains – standard IEC socket.

Connecting your Scarlett 18i20

Power

The Scarlett 18i20 should be connected to AC mains with the supplied AC power cable. Plug the IEC connector into the rear panel IEC socket. When using the Scarlett 18i20 with a computer (i.e., not as a “stand-alone” mixer), we recommend the unit is not turned on until the USB connection has been made – see below.

USB

USB Port Types: The Scarlett 18i20 has a single Type C USB 2.0 port (on the rear panel). Once the software installation is complete, connect the Scarlett 18i20 to your computer; if your computer has a Type A USB port use the Type A-to-Type C USB cable provided with the unit. If your computer has a Type C USB port, please obtain a Type C-to-Type C cable from a computer supplier.

USB Standards: Note that because the Scarlett 18i20 is a USB 2.0 device, the USB connection requires a USB 2.0-compliant port on your computer. It will not operate with USB 1.0/1.1 ports: however, a USB 3.0 port will support a USB 2.0 device.

When the USB cable has been connected, turn on the Scarlett 18i20 with the power switch on the front panel.

Audio Setup in your DAW

The Scarlett 18i20 is compatible with any Windows-based DAW that supports ASIO or WDM and any Mac-based DAW that uses Core Audio. After following the Getting Started procedure described on page 6, you can start using the Scarlett 18i20 with the DAW of your choice.

To allow you to get started if you do not already have a DAW application installed on your computer, both Pro Tools | First and Ableton Live Lite are included; these will be available to you once you've registered your Scarlett 18i20. If you need help installing either DAW, please visit our Getting Started pages at focusrite.com/get-started, where Getting Started videos are available.

Operating instructions for Pro Tools | First and Ableton Live Lite are beyond the scope of this User Guide, but both applications include a full set of Help files. Instructions are also available at avid.com and ableton.com respectively. You can find a video tutorial on getting started with Ableton Live Lite at focusrite.com/get-started.

Please note - your DAW may not automatically select the Scarlett 18i20 as its default I/O device. You must manually select the driver on your DAW's **Audio Setup*** page (select **Scarlett 18i20** for Mac or **Focusrite USB ASIO** for Windows). Please refer to your DAW's documentation (or Help files) if you are unsure where to select the ASIO/ Core Audio driver. The example below shows the correct configuration in the Ableton Live Lite **Preferences** panel (Windows version shown).

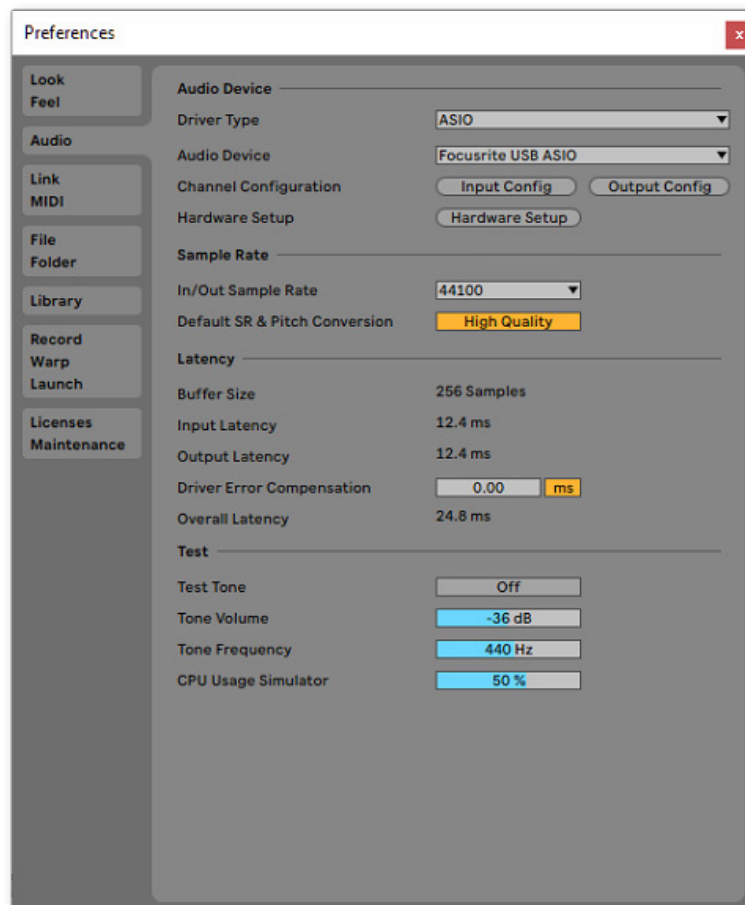

* Typical name. Terminology may differ between DAWs.

Once the Scarlett 18i20 is set as the preferred Audio Device* in your DAW, all 18 inputs and 20 outputs will appear in your DAW's Audio I/O preferences (note however Ableton Live Lite is limited to a maximum of four simultaneous mono input channels and four simultaneous mono output channels). Depending on your DAW, you may need to enable certain inputs or outputs before use.

The two examples below show two inputs and two outputs enabled in Ableton Live Lite's **Input Config** and **Output Config** pages.

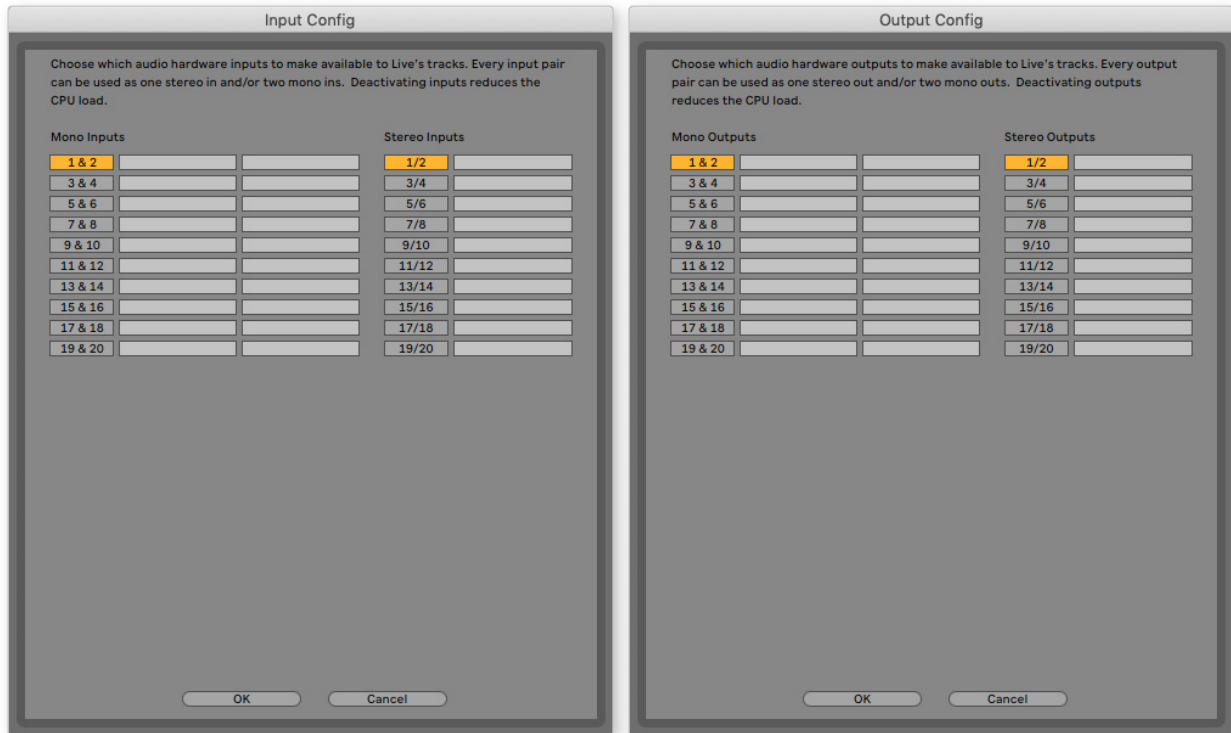

* Typical name. Terminology may differ between DAWs.

Loopback Inputs

You will notice two additional inputs - "Inputs 9 & 10" - will be listed on the Input Config page of your DAW's I/O Preferences. These are virtual "loopback" inputs within software, not additional physical inputs. They can be used to record DAW tracks from sources within your computer, e.g., from a web browser. Focusrite Control includes a **Loopback 1-2** mix tab, where you can choose which inputs to record.

Full details of how to use the loopback inputs can be found in the Focusrite Control User Guide.

Examples of Usage

The Scarlett 18i20 is an excellent choice for several different recording and monitoring applications. Some typical configurations are shown below.

Recording a band

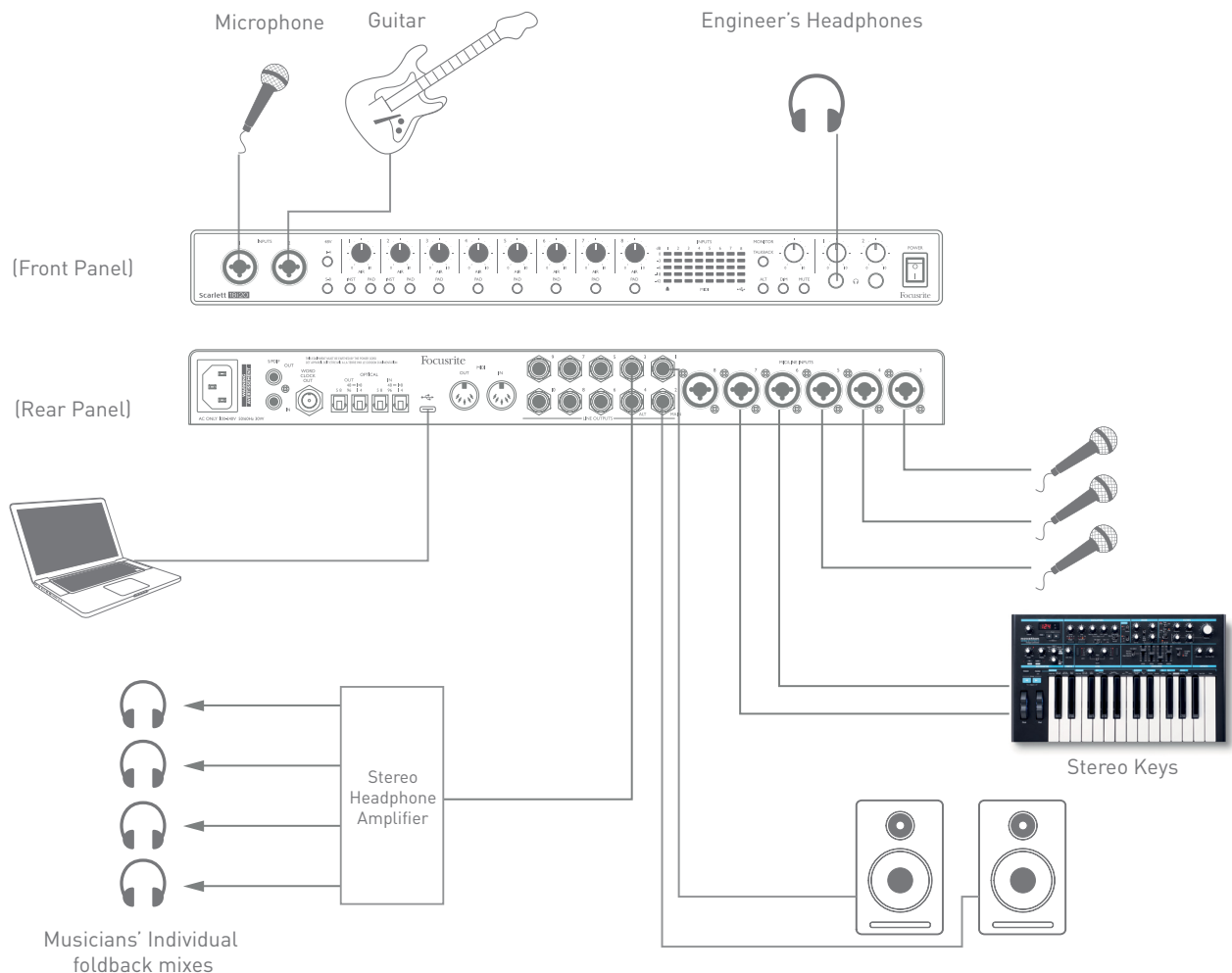

This setup shows a typical configuration for recording a group of musicians with DAW software on Mac or PC.

A selection of sources – microphones, guitar and a keyboard – are shown connected to the Scarlett 18i20's inputs. Note that only Inputs 1 and 2 can be configured to accept instruments directly, so we have chosen to plug the guitar into Input 2. Ensure **INST** is selected for this input.

The connection to the PC or Mac running DAW software is via the USB cable supplied. This will carry all the input and output signals between the DAW and the Scarlett 18i20. Once the audio setup is configured in the DAW, each input source will be routed to its own DAW track for recording.

Low Latency Monitoring

You will frequently hear the term “latency” used in connection with digital audio systems. In the case of the simple DAW recording application described above, latency will be the time it takes for your input signals to pass through your computer and audio software, and back out again via your audio interface. While not an issue for most simple recording situations, under some circumstances, latency can be a problem for a performer who wishes to record while monitoring their input signals. This might be the case if you need to increase the size of your DAW’s recording buffer, which could be necessary when you record overdubs on a particularly large project using many DAW tracks, software instruments and FX plug-ins. Common symptoms of a buffer setting too low could be glitching audio (clicks and pops), or a particularly high CPU load within your DAW (most DAWs have a CPU monitoring function). Most DAWs will allow you adjust buffer size from their **Audio Preferences*** control page.

The Scarlett 18i20, with Focusrite Control, allows “zero latency monitoring”, which overcomes this problem. You can route your input signals directly to the Scarlett 18i20’s headphone outputs. This enables the musicians to hear themselves with ultra-low latency – i.e., effectively in “real time” – along with the computer playback. The input signals to the computer are not affected in any way by this setting. However, note that any effects being added to the live instruments by software plug-ins will not be heard in the headphones although the FX will still be present on the recording.

In the example, each of the band members is receiving his/her own monitor mix, because they each have their “own” Scarlett 18i20 output. Focusrite Control lets you define up to eight separate mixes, and these mixes may include previously recorded DAW tracks as well the current input signals.

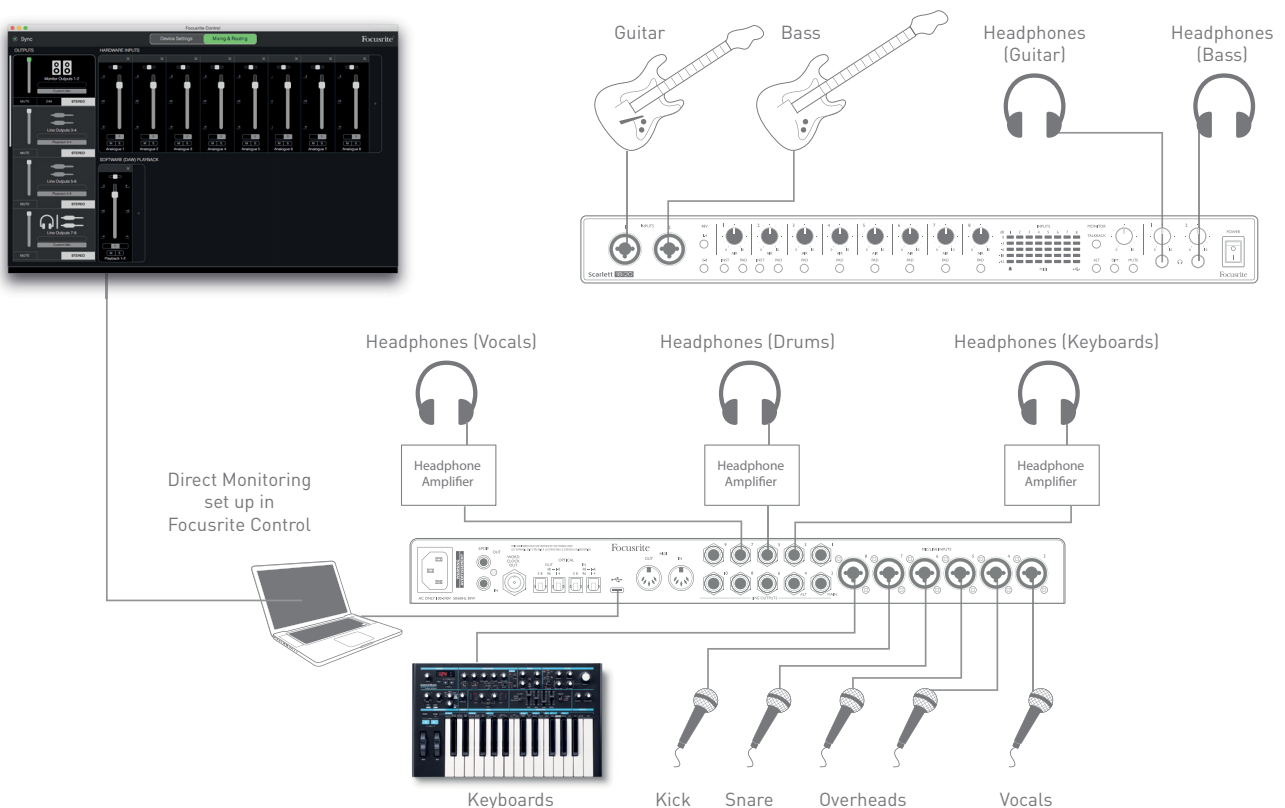

When using Direct Monitoring, ensure your DAW software is not set to route any inputs (what you are currently recording) to any outputs. If it is, the musicians will hear themselves “twice”, with one signal audibly delayed as an echo.

Connecting Scarlett 18i20 to loudspeakers

The 1/4" jack **MAIN** outputs on the rear panel (Line Outputs 1 and 2) will normally be used to drive your primary monitoring speakers. Active monitors incorporate internal amplifiers with a volume control, and may be connected directly. Passive loudspeakers will require a separate stereo amplifier; the rear panel outputs should be connected to the amplifier's inputs.

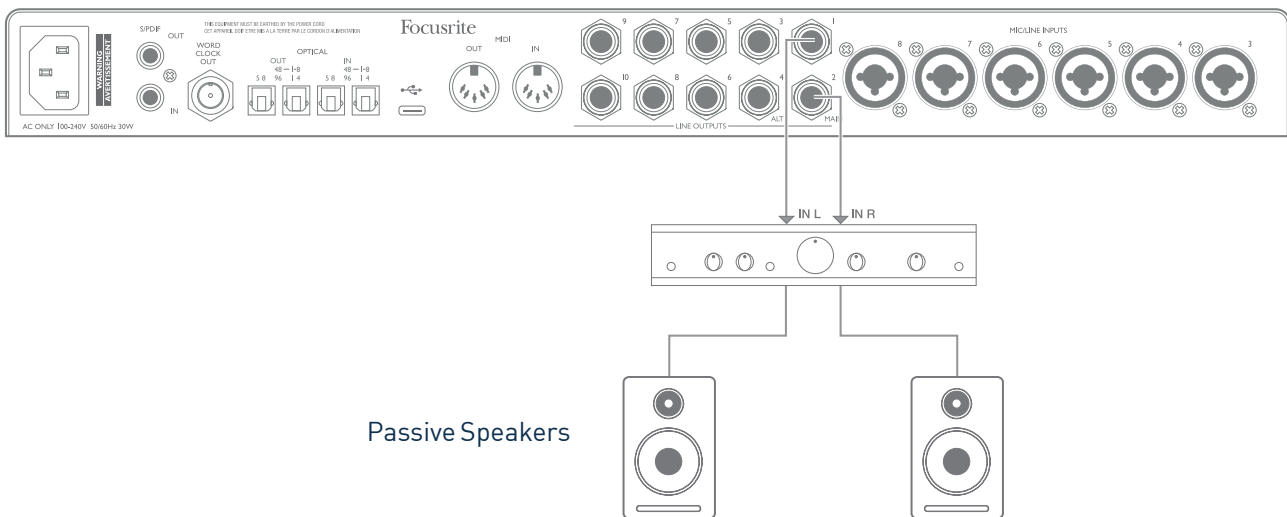
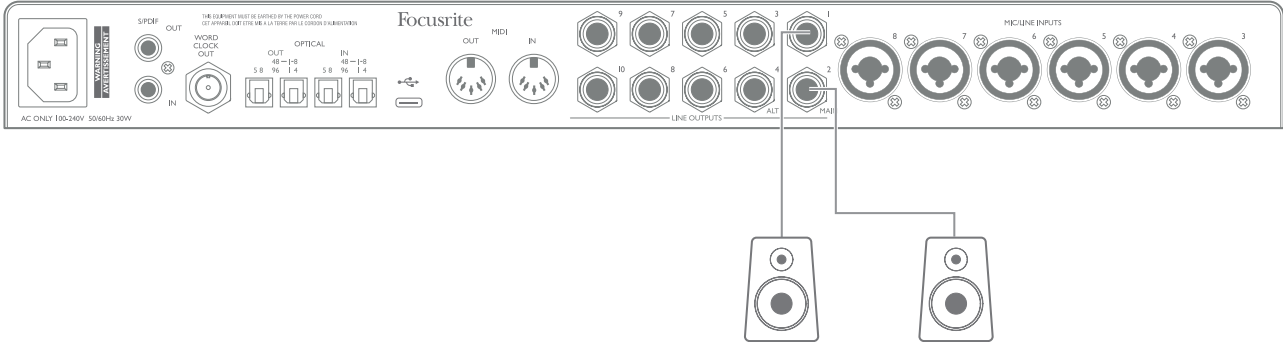

Passive Speakers

All the line output connectors are 3-pole (TRS) 1/4" (6.35 mm) jack sockets, and are electronically balanced. Typical consumer (hi-fi) amplifiers and small powered monitors will probably have unbalanced inputs, either on phono (RCA) sockets, or via a 3.5 mm 3-pole jack plug intended for direct connection to a computer. In either case, use a suitable connecting cable with jack plugs at one end.

Professional active monitors and professional power amplifiers will generally have balanced inputs.

When mixing, you might want to use several pairs of additional speakers (mid-field, near-field, etc.) to check how well your mix translates to other types of speaker. You can connect additional pairs of speakers to other pairs of Line Outputs (e.g., near-fields to Line Outputs 3 and 4, mid-fields to Line Outputs 5 and 6) and switch between them in Focusrite Control. Scarlett 18i20's ALT function (see below) has been included to make using a second pair of monitors simple.

NOTE: You run the risk of creating an audio feedback loop if loudspeakers are active at the same time as a microphone! We recommend you always turn off (or turn down) monitoring loudspeakers while recording, and use headphones when overdubbing.

IMPORTANT:

LINE OUTPUTS 1 to 4 incorporate “anti-thump” circuitry to protect your speakers if the Scarlett 18i20 is turned on while the speakers (and amplifier if used) are connected and active.

LINE OUTPUTS 5 to 10 do not have this circuitry. If you’re using additional speakers connected to these outputs, first power your Scarlett 18i20 on, then turn on the speakers or power amplifier.

Get into the habit of following this rule - it is good audio practice to turn on a speaker system of any kind after turning on the equipment feeding it.

Speaker Switching

The 18i20’s Speaker Switching function makes adding a second pair of monitors easy: connect the second pair to the **ALT** outputs – **LINE OUTPUTS 3 and 4**. After enabling Speaker Switching in Focusrite Control, you can switch between your main monitors and the secondary pair either by pressing the front panel **ALT** button, or by clicking on the corresponding on-screen button in Focusrite Control. When ALT is active, the main mix output will be fed to the **ALT** outputs instead of the **MAIN**, and the green ALT LED will light to confirm this.

In the example below, we have shown passive speakers with a separate power amplifier as the main monitors and active speakers as the secondary pair, but of course, any type of monitors you prefer may be used in either case.

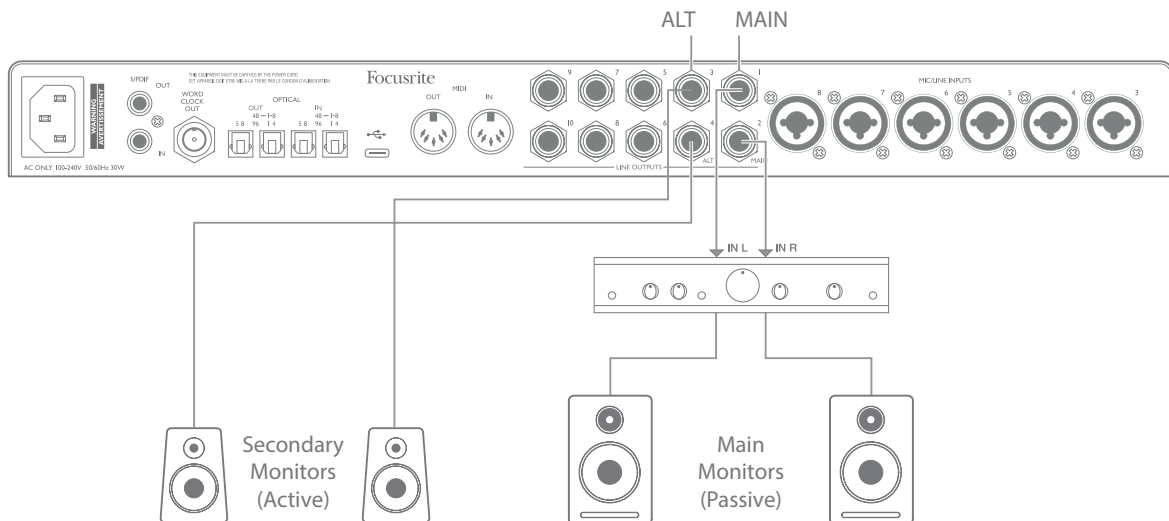

Working with surround sound

Because the Scarlett 18i20 is equipped with ten line outputs, it is ideally suited for use when working in multichannel sound formats – LCRS, 5.1 surround or 7.1 surround, for example.

To route each channel to the correct output you will need to route the DAW outputs to the Line Outputs in Focusrite Control (e.g. DAW Output 1 > Line Output 1, DAW Output 2 > Line Output 2, etc.).

The example below shows how you connect the six loudspeakers to the Scarlett 18i20 in a 5.1 surround monitoring arrangement.

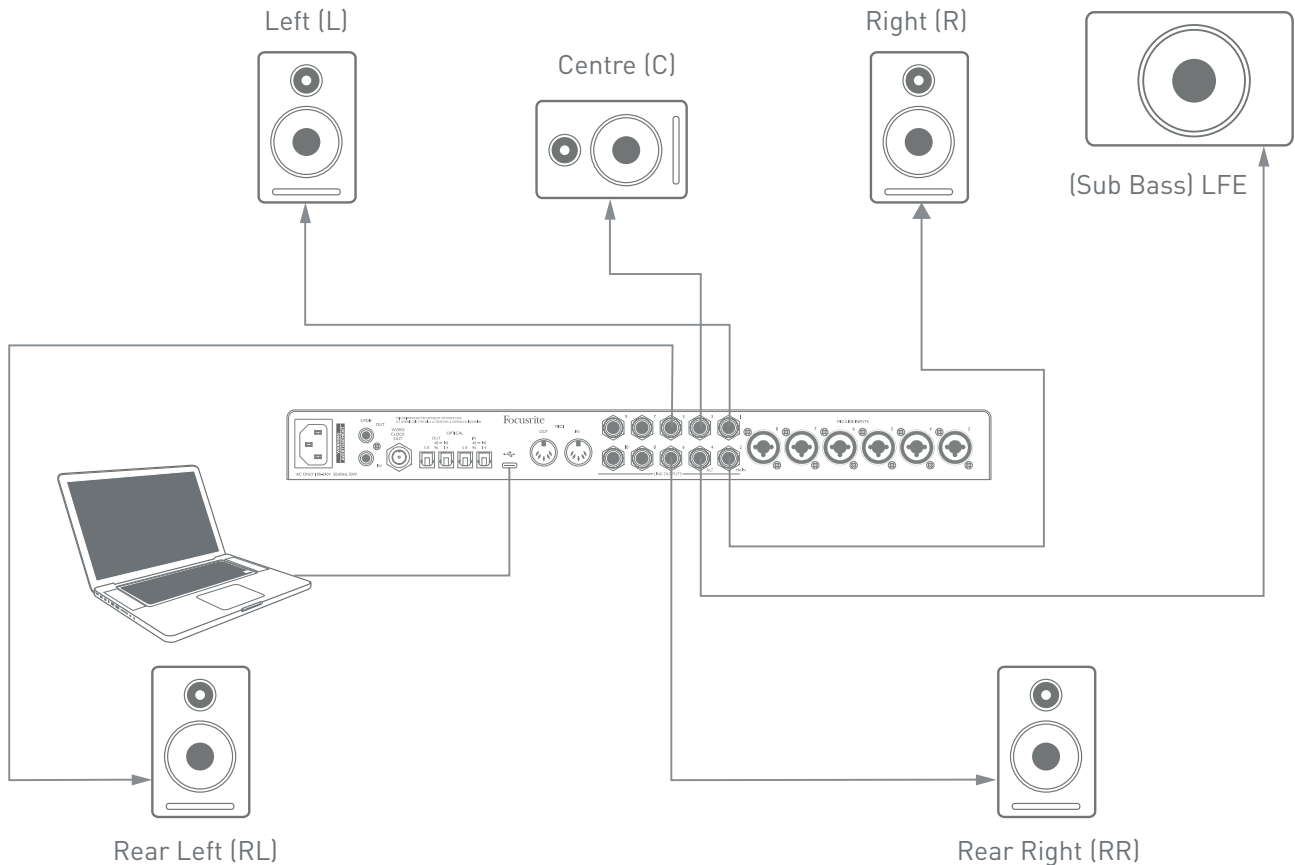

Windows users:

In Windows, surround sound can be used in both software supporting multichannel ASIO and non-ASIO applications (using our driver). In most cases this will be your DAW, and in general, DAWs capable of mixing in surround allow you to set the speaker mapping up in the DAW's **Audio Output Preferences** or **I/O Settings** page.

Please see the User Manual (or Help files) for your DAW for guidance on setting up the outputs for surround mixing with the speaker configuration you wish to use.

To setup surround sound in non-ASIO applications

1. Right-Click on the Focusrite Notifier icon in your Windows taskbar and click to open Windows Sound Panel.
2. Click the Focusrite device listed in the Playback tab to highlight it.
3. Click the Configure button.
4. Select a multichannel format. Note that the options you choose depend on how you are using your Scarlett.
5. Go to Focusrite Control and click, File > Presets > Direct Routing, to set up one-to-one routing.

Mac users:

On Macs, surround sound configuration can be done from all applications that support multichannel audio (DAWs & regular macOS Applications). To do this, go to: **Applications > Utilities > Audio MIDI Setup > Scarlett 18i20 > Configure Speakers > Configuration > Select the desired configuration.**

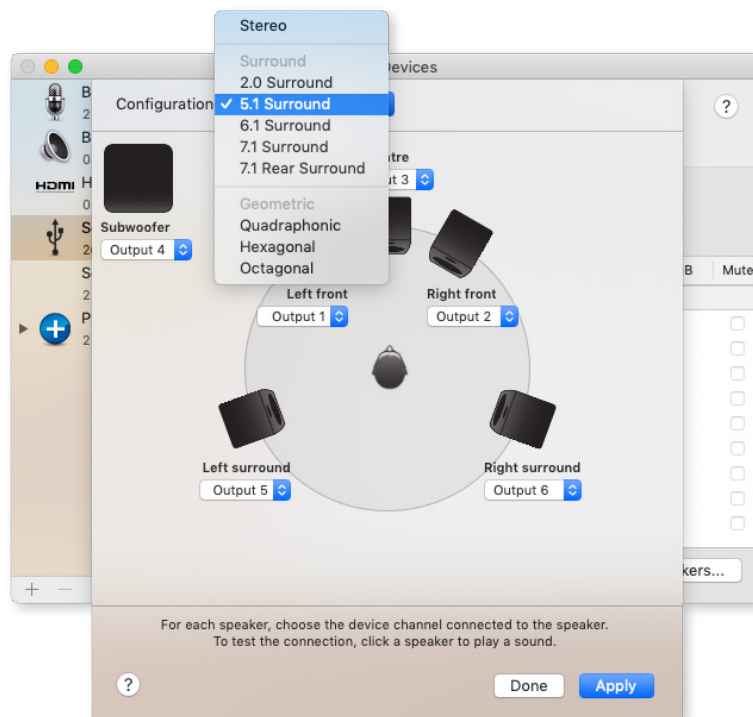

Using the ADAT connection

In addition to the eight analogue inputs, the Scarlett 18i20 has two **OPTICAL IN** ADAT input ports. These provide eight additional audio inputs at sample rates up to 96 kHz. The optical inputs are disabled at sample rates of 176.4/192 kHz.

Using a separate 8-channel microphone preamplifier equipped with an ADAT output – such as the Focusrite Scarlett OctoPre – provides a simple and excellent method of expanding the Scarlett 18i20's input capability.

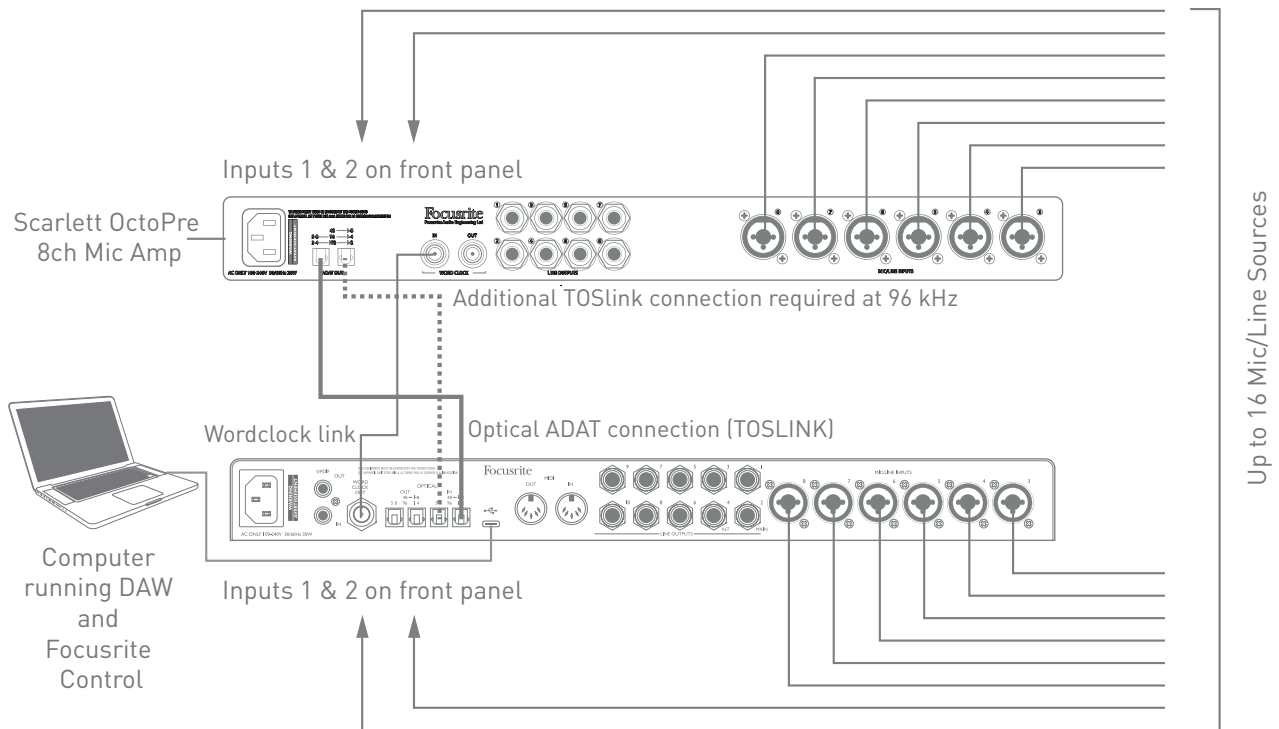

At 44.1/48 kHz, the Scarlett OctoPre's **ADAT OUT 1-8** port is connected to the Scarlett 18i20 **OPTICAL IN** port **48 – 1-8** with a single TOSLINK optical cable. To synchronise the devices over ADAT, set the clock source of the Scarlett OctoPre to **Internal** and Scarlett 18i20 (via Focusrite Control) to **ADAT**. Alternatively, stable clock synchronisation may be achieved by connecting the Scarlett 18i20's **WORD CLOCK OUT** to the Scarlett OctoPre's **WORD CLOCK IN** and setting the Scarlett OctoPre to use Word Clock as its clock source. Set the Scarlett 18i20's clock source in Focusrite Control to **Internal**.

When connecting two digital devices, always ensure both are set to the same sample rate.

You can route the additional ADAT inputs using Focusrite Control in exactly the same way as the other inputs. The additional inputs can form part of any musician's headphone mix, as required.

When working at 88.2/96 kHz, add a second TOSLINK optical cable between the Scarlett OctoPre's **ADAT OUT 5-8** port and the 18i20's **OPTICAL IN 5-8 – 96** port. At the higher sample rate, this second link will carry Channels 5-8, while the other link (described above) will carry Channels 1 to 4.

If you have a digital-to-analogue converter, you can use the 18i20's **OPTICAL OUT** ADAT ports in the opposite way; for example, additional outputs from your DAW can be converted into the analogue domain to use an external hardware mixing console to mix down a large number of DAW tracks. At 44.1/48 kHz sample rate, the right-hand **OPTICAL OUT** port carries Channels 1 to 8, while at 88.2/96 kHz, the right-hand port carries Channels 1 to 4 and the left-hand port Channels 5 to 8.

Using the Scarlett 18i20 as a stand-alone mixer

The Scarlett 18i20 has the ability to store a mix configuration defined in Focusrite Control within the hardware. This feature lets you configure it – for example, as an on-stage keyboard mixer – using your computer, and upload the configuration to the device itself. You can use the Scarlett 18i20 as a simple local mixer as part of your keyboard rig to control the overall mix of multiple keyboards.

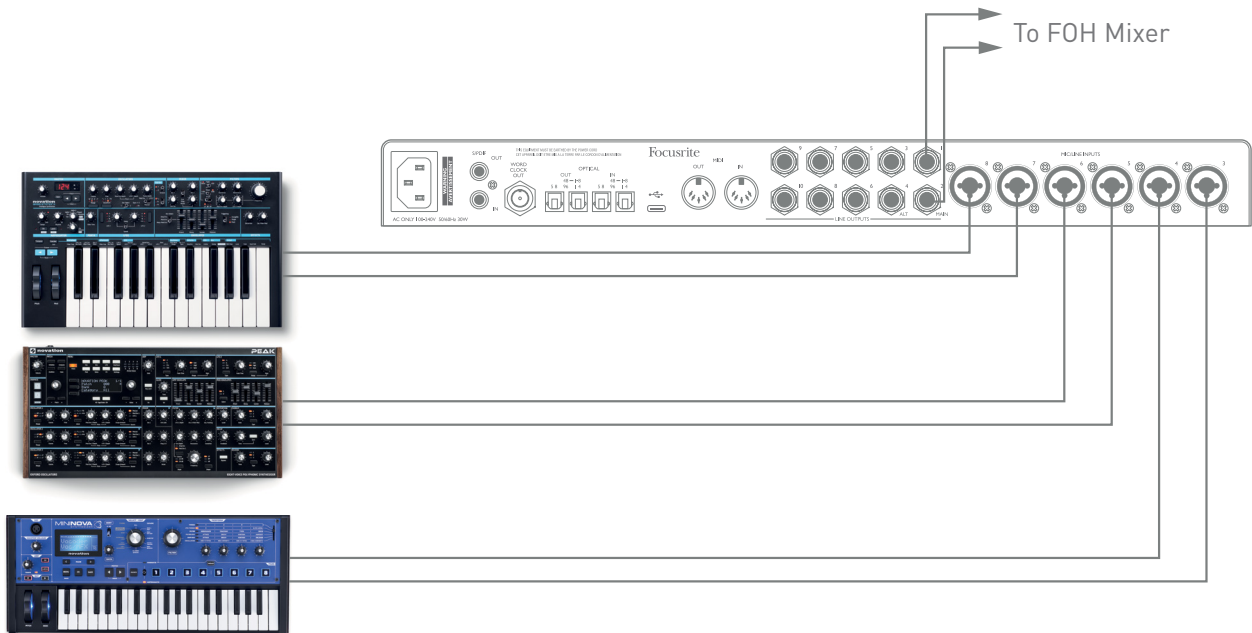

In the example illustrated, three stereo keyboards are connected to the rear panel inputs of the Scarlett 18i20; Outputs 3 and 4 go to the main PA system. The performer can adjust the gain for the individual keyboards from the front panel; he/she can also adjust the overall level of the keyboard mix.

Using the Scarlett 18i20 as a stand-alone preamp

Using the digital connections on the Scarlett 18i8 3rd gen it is possible to use it as a two-channel (S/PDIF) or up to eight-channel (ADAT) standalone preamp.

You can connect input sources to any of the inputs on the Scarlett (microphone, line or inst) and using Focusrite Control you can route the analogue inputs directly to the S/PDIF or ADAT outputs. Then you can connect the digital output you are using to the S/PDIF or ADAT input on another interface to expand that interface's channel count. For example a second Scarlett 18i20's ADAT input port.

FOCUSRITE CONTROL

Focusrite Control software allows flexible mixing and routing of all audio signals to the physical audio outputs, as well as control of output monitor levels. Sample rate selection and digital sync options are also available from Focusrite Control.

NOTE: Focusrite Control is a generic product, and may be used with several other Focusrite interfaces. When you connect an interface to your computer and launch Focusrite Control, the model of interface is automatically detected, and the software configured to suit the inputs and outputs, and other facilities, available on the hardware.

IMPORTANT: A separate Focusrite Control User Guide can be downloaded from the downloads area of the Focusrite website. This describes the use of Focusrite Control in full detail, together with examples of application.

To open Focusrite Control:



Installing Focusrite Control on your computer will place the Focusrite Control icon on the dock or desktop. Click the icon to launch Focusrite Control.

Assuming your Scarlett interface is connected to your computer with the USB cable, the Focusrite Control GUI (Graphical User Interface) will appear as shown below (Mac version illustrated).



Please refer to the Focusrite Control User Guide for further details. This is available from:

focusrite.com/downloads

Channel Listing tables

The 18i20's inputs and outputs will appear in Focusrite Control with different channel numbers depending on the sample rate being used. The channel numbers will also vary when the optical ADAT ports are in use, depending on which Digital I/O Mode is selected (see Digital I/O Modes below).

Digital I/O Modes

The Scarlett 18i20 supports three Digital I/O modes: these are selected from the Device Settings pane of Focusrite Control. The modes determine how the audio inputs and outputs are mapped to the optical (ADAT) ports and the S/PDIF input and output coaxial (RCA) sockets.

Mode 1: Coaxial (RCA) S/PDIF

This is the factory default mode, and your Scarlett 18i20 will adopt these assignments "out-of-the-box". Use this mode if you need a coaxial S/PDIF audio input, or if you wish to use a coaxial S/PDIF signal as a clock source.

Digital port		Sample rate (kHz)		
		44.1/48	88.2/96	176.4/192
Inputs	S/PDIF IN	S/PDIF	S/PDIF	S/PDIF
	OPTICAL IN 1	ADAT 1-8	ADAT 1-4	x
	OPTICAL IN 2	x	x	x
Outputs	S/PDIF OUT	S/PDIF	S/PDIF	S/PDIF
	OPTICAL OUT 1	ADAT 1-8	ADAT 1-4	x
	OPTICAL OUT 2	ADAT 1-8	ADAT 1-4	x

Mode 2: Optical S/PDIF

Select this mode when you are working at 44.1/48 or 88.2/96 kHz sample rate and you need to send or receive an S/PDIF signal via an optical port. Also use this mode if you want to use a clock source sent as an optical S/PDIF signal.

Digital port		Sample rate (kHz)		
		44.1/48	88.2/96	176.4/192
Inputs	S/PDIF IN	x	x	x
	OPTICAL IN 1	ADAT 1-8	ADAT 1-4	x
	OPTICAL IN 2	S/PDIF	S/PDIF	x
Outputs	S/PDIF OUT	S/PDIF	S/PDIF	S/PDIF
	OPTICAL OUT 1	ADAT 1-8	ADAT 1-4	x
	OPTICAL OUT 2	S/PDIF	S/PDIF	x

Mode 3: Dual ADAT

Select this mode when you need more than four ADAT input and/or output channels when working at 88.2/96 kHz sample rate.

Digital port		Sample rate (kHz)		
		44.1/48	88.2/96	176.4/192
Inputs	S/PDIF IN	x	x	x
	OPTICAL IN 1	ADAT 1-8	ADAT 1-4	x
	OPTICAL IN 2	x	ADAT 5-8	x
Outputs	S/PDIF OUT	S/PDIF	S/PDIF	S/PDIF
	OPTICAL OUT 1	ADAT 1-8	ADAT 1-4	x
	OPTICAL OUT 2	ADAT 1-8	ADAT 5-8	x

The tables below list the how the 18i20's inputs and outputs appear in Focusrite Control for each of the three Optical I/O modes, at each of the three sample rate pairs. Note that the first digit in the entries relating to the ADAT channels refers to the port in use: so "ADAT 1.1" to "ADAT 1.4" are ADAT Chs 1 to 4 at the right-hand port of each pair, while "ADAT 2.1" to "ADAT 2.4" are ADAT Chs 5 to 8 at the left-hand port of each pair.

At 44.1 kHz and 48 kHz sample rates:

INPUTS	DIGITAL I/O MODE		
	COAXIAL S/PDIF	OPTICAL S/PDIF	DUAL ADAT
Input 1	Input 1	Input 1	Input 1
Input 2	Input 2	Input 2	Input 2
Input 3	Input 3	Input 3	Input 3
Input 4	Input 4	Input 4	Input 4
Input 5	Input 5	Input 5	Input 5
Input 6	Input 6	Input 6	Input 6
Input 7	Input 7	Input 7	Input 7
Input 8	Input 8	Input 8	Input 8
Loopback 1	Loopback 1	Loopback 1	Loopback 1
Loopback 2	Loopback 2	Loopback 2	Loopback 2
Digital In 1	S/PDIF 1 (via co-ax socket)	S/PDIF 1 (via optical port)	x
Digital In 2	S/PDIF 2 (via co-ax socket)	S/PDIF 2 (via optical port)	x
Digital In 3	ADAT 1.1	ADAT 1.1	ADAT 1.1
Digital In 4	ADAT 1.2	ADAT 1.2	ADAT 1.2
Digital In 5	ADAT 1.3	ADAT 1.3	ADAT 1.3
Digital In 6	ADAT 1.4	ADAT 1.4	ADAT 1.4
Digital In 7	ADAT 1.5	ADAT 1.5	ADAT 1.5
Digital In 8	ADAT 1.6	ADAT 1.6	ADAT 1.6
Digital In 9	ADAT 1.7	ADAT 1.7	ADAT 1.7
Digital In 10	ADAT 1.8	ADAT 1.8	ADAT 1.8

OUTPUTS	DIGITAL I/O MODE		
	COAXIAL S/PDIF	OPTICAL S/PDIF	DUAL ADAT
Output 1	Output 1	Output 1	Output 1
Output 2	Output 2	Output 2	Output 2
Output 3	Output 3	Output 3	Output 3
Output 4	Output 4	Output 4	Output 4
Output 5	Output 5	Output 5	Output 5
Output 6	Output 6	Output 6	Output 6
Output 7	Output 7	Output 7	Output 7
Output 8	Output 8	Output 8	Output 8
Output 9	Output 9	Output 9	Output 9
Output 10	Output 10	Output 10	Output 10
Output 11	S/PDIF 1 (via co-ax socket)	S/PDIF 1 (via co-ax socket and optical port)	S/PDIF 1 (via co-ax socket)
Output 12	S/PDIF 2 (via co-ax socket)	S/PDIF 2 (via coaxial socket and optical port)	S/PDIF 2 (via co-ax socket)
Output 13	ADAT 1.1	ADAT 1.1	ADAT 1.1
Output 14	ADAT 1.2	ADAT 1.2	ADAT 1.2
Output 15	ADAT 1.3	ADAT 1.3	ADAT 1.3
Output 16	ADAT 1.4	ADAT 1.4	ADAT 1.4
Output 17	ADAT 1.5	ADAT 1.5	ADAT 1.5
Output 18	ADAT 1.6	ADAT 1.6	ADAT 1.6
Output 19	ADAT 1.7	ADAT 1.7	ADAT 1.7
Output 20	ADAT 1.8	ADAT 1.8	ADAT 1.8

At 88.2 kHz and 96 kHz sample rates:

INPUTS	DIGITAL I/O MODE		
	COAXIAL S/PDIF	OPTICAL S/PDIF	DUAL ADAT
Input 1	Input 1	Input 1	Input 1
Input 2	Input 2	Input 2	Input 2
Input 3	Input 3	Input 3	Input 3
Input 4	Input 4	Input 4	Input 4
Input 5	Input 5	Input 5	Input 5
Input 6	Input 6	Input 6	Input 6
Input 7	Input 7	Input 7	Input 7
Input 8	Input 8	Input 8	Input 8
Loopback 1	Loopback 1	Loopback 1	Loopback 1
Loopback 2	Loopback 2	Loopback 2	Loopback 2
Digital In 1	S/PDIF 1 (via co-ax socket)	S/PDIF 1 (via optical port)	ADAT 1.1
Digital In 2	S/PDIF 2 (via co-ax socket)	S/PDIF 2 (via optical port)	ADAT 1.2
Digital In 3	ADAT 1.1	ADAT 1.1	ADAT 1.3
Digital In 4	ADAT 1.2	ADAT 1.2	ADAT 1.4
Digital In 5	ADAT 1.3	ADAT 1.3	ADAT 2.1
Digital In 6	ADAT 1.4	ADAT 1.4	ADAT 2.2
Digital In 7	x	x	ADAT 2.3
Digital In 8	x	x	ADAT 2.4

OUTPUTS	DIGITAL I/O MODE			
	COAXIAL S/PDIF	OPTICAL S/PDIF	DUAL ADAT	DUAL ADAT OUTPUT PRESET*
Output 1	Output 1	Output 1	Output 1	Output 1
Output 2	Output 2	Output 2	Output 2	Output 2
Output 3	Output 3	Output 3	Output 3	Output 3
Output 4	Output 4	Output 4	Output 4	Output 4
Output 5	Output 5	Output 5	Output 5	Output 5
Output 6	Output 6	Output 6	Output 6	Output 6
Output 7	Output 7	Output 7	Output 7	Output 7
Output 8	Output 8	Output 8	Output 8	Output 8
Output 9	Output 9	Output 9	Output 9	Output 9
Output 10	Output 10	Output 10	Output 10	Output 10
Output 11	S/PDIF 1 (via co-ax socket)	S/PDIF 1 (via co-ax socket and optical port)	S/PDIF 1 (via co-ax socket)	ADAT 1.1
Output 12	S/PDIF 2 (via co-ax socket)	S/PDIF 2 (via coaxial socket and optical port)	S/PDIF 2 (via co-ax socket)	ADAT 1.2
Output 13	ADAT 1.1	ADAT 1.1	ADAT 1.1	ADAT 1.3
Output 14	ADAT 1.2	ADAT 1.2	ADAT 1.2	ADAT 1.4
Output 15	ADAT 1.3	ADAT 1.3	ADAT 1.3	ADAT 2.1
Output 16	ADAT 1.4	ADAT 1.4	ADAT 1.4	ADAT 2.2
Output 17	x	x	ADAT 2.1	ADAT 2.3
Output 18	x	x	ADAT 2.2	ADAT 2.4
Output 19	x	x	x	x
Output 20	x	x	x	x

*To obtain eight ADAT output channels, please select Focusrite Control's DUAL ADAT OUTPUT preset.

At 176.4 kHz and 192 kHz sample rates:

INPUTS	DIGITAL I/O MODE		
	COAXIAL S/PDIF	OPTICAL S/PDIF	DUAL ADAT
Input 1	Input 1	Input 1	Input 1
Input 2	Input 2	Input 2	Input 2
Input 3	Input 3	Input 3	Input 3
Input 4	Input 4	Input 4	Input 4
Input 5	Input 5	Input 5	Input 5
Input 6	Input 6	Input 6	Input 6
Input 7	Input 7	Input 7	Input 7
Input 8	Input 8	Input 8	Input 8
Digital In 1	S/PDIF 1 (via co-ax socket)	x	x
Digital In 2	S/PDIF 2 (via co-ax socket)	x	x

OUTPUTS	DIGITAL I/O MODE		
	COAXIAL S/PDIF	OPTICAL S/PDIF	DUAL ADAT
Output 1	Output 1	Output 1	Output 1
Output 2	Output 2	Output 2	Output 2
Output 3	Output 3	Output 3	Output 3
Output 4	Output 4	Output 4	Output 4
Output 5	Output 5	Output 5	Output 5
Output 6	Output 6	Output 6	Output 6
Output 7	Output 7	Output 7	Output 7
Output 8	Output 8	Output 8	Output 8
Output 9	Output 9	Output 9	Output 9
Output 10	Output 10	Output 10	Output 10
Output 11	x	x	x
Output 12	x	x	x
Output 13	x	x	x
Output 14	x	x	x
Output 15	x	x	x
Output 16	x	x	x
Output 17	x	x	x
Output 18	x	x	x
Output 19	x	x	x
Output 20	x	x	x

SPECIFICATIONS

Performance Specifications

All performance figures measured in accordance with the provisions of AES17, as applicable.

Configuration	
Inputs	18: analogue (8), ADAT (8), S/PDIF (2)
Outputs	20: analogue (10), ADAT (8), S/PDIF (2)
Mixer	Fully assignable 18-in/10-out software mixer (Focusrite Control)
Custom Mixes	12 mono
Maximum custom mix inputs	24 mono
Supported sample rates	44.1 kHz, 48 kHz, 88.2 kHz, 96 kHz, 176.4 kHz, 192 kHz
Microphone Inputs 1 to 8	
Dynamic Range	111 dB (A-weighted)
Frequency Response	20 Hz to 20 kHz \pm 0.1 dB
THD+N	< 0.0012% (minimum gain, -1 dBFS input with 22 Hz/22 kHz bandpass filter)
Noise EIN	-128 dB (A-weighted)
Maximum Input Level	+9 dBu (no PAD); +16 dBu (PAD selected); measured at minimum gain
Gain Range	56 dB
Input Impedance	3 k Ω
Line Inputs 1 to 8	
Dynamic Range	110.5 dB (A-weighted)
Frequency Response	20 Hz to 20 kHz \pm 0.1 dB
THD+N	< 0.002% (minimum gain, -1 dBFS input with 22 Hz/22 kHz bandpass filter)
Maximum Input Level	+22 dBu (no PAD); +29.5 dBu (PAD selected); measured at minimum gain
Gain Range	56 dB
Input Impedance	60 k Ω

Instrument Inputs 1 and 2	
Dynamic Range	110 dB (A-weighted)
Frequency Response	20 Hz to 20 kHz \pm 0.1 dB
THD+N	< 0.03% (minimum gain, -1 dBFS input with 22 Hz/22 kHz bandpass filter)
Maximum Input Level	+12.5 dBu (no PAD); +14 dBu (PAD selected); measured at minimum gain
Gain Range	56 dB
Input Impedance	1.5 M Ω
Line Outputs 1 to 10	
Dynamic Range	108.5 dB (A-weighted)
Maximum Output Level (0 dBFS)	+15.5 dBu (balanced)
THD+N	< 0.002% (-1 dBFS input with 22 Hz/22 kHz bandpass filter)
Output Impedance	430 Ω
Headphone Outputs	
Dynamic Range	104 dB (A-weighted)
Maximum Output Level	+7 dBu
THD+N	< 0.002% (measured at +6 dBu with 22 Hz/22 kHz bandpass filter)
Output Impedance	< 1 Ω

Physical and Electrical Characteristics

Analogue Inputs 1 & 2	
Connectors	XLR Combo type: Mic/Line/Inst, on front panel
Mic/Line switching	Automatic
Line/Instrument switching	2 x front panel switches or via Focusrite Control
Pad	10 dB attenuation, selected per channel from Focusrite Control
Phantom power	Shared +48 V phantom power switch for inputs 1 to 4
AIR function	Selected per channel from Focusrite Control
Analogue Inputs 3 to 8	
Connectors	XLR Combo: Mic/Line, on rear panel
Mic/Line switching	Automatic
Pad	10 dB attenuation, selected per channel from Focusrite Control
Phantom power	Shared +48 V phantom power switches for inputs 1 to 4 and 5 to 8
AIR function	Selected per channel from Focusrite Control
Analogue Outputs	
Main outputs	10 x balanced ¼" TRS jacks on rear panel
Stereo headphone outputs	2 x ¼" TRS jack on front panel
Main monitor output level control	On front panel
Headphones level controls	
Other I/O	
Optical I/O	4 x TOSLINK optical connectors; 8 channels @ 44.1/48 kHz or 4 @ 88.2/96 kHz
S/PDIF I/O	2 x phono (RCA) or via Optical I/O (selected via Focusrite Control)
Word clock output	BNC connector
USB	1 x USB 2.0 Type C connector
MIDI I/O	2 x 5-pin DIN sockets

Front Panel indicators	
USB/Power	Green LED
Phantom power	2 x red LEDs (Chs 1-4, 5-8)
Instrument mode	2 x red LEDs (Chs 1 & 2)
AIR mode	8 x yellow LEDs
Pad active	8 x green LEDs
MIDI data received	Green LED
Lock indicator	Green LED
Talkback active	Green LED
ALT speakers selected	Green LED
Monitors DIM and MUTE	Yellow LED (DIM); red LED (MUTE)
Weight and Dimensions	
W x D x H	482.6 mm x 46.6 mm (1U) x 259.8 mm 19 in x 1.83 in (1U) x 10.23 in
Weight	3.195 kg 7.16 lb

TROUBLESHOOTING

For all troubleshooting queries, please visit the Focusrite Help Centre at support.focusrite.com.

COPYRIGHT AND LEGAL NOTICES

Full Terms and Conditions of the Warranty can be found at focusrite.com/warranty.

Focusrite is a registered trade mark and Scarlett 18i20 is a trade mark of Focusrite Audio Engineering Limited.

All other trade marks and trade names are the property of their respective owners.
2021 © Focusrite Audio Engineering Limited. All rights reserved.