



# Red Range Manual

featuring Red 1,3,7 & 8

# Dear Focusrite Customer...

Thank you very much for buying one or more of our products from the Studio Product Range.

Focusrite products enjoy a prestigious reputation in the world of music recording, which is now spreading to live performance, broadcast and post production applications too.

This is the result of an almost fanatical approach to audio design coupled with unique industrial design. Build and component quality are also extremely important to us.

Put together, these attributes result in products which hopefully exceed the expectations of those people who buy and use them.

To ensure this is the case I would ask you to go online to [www.focusrite.com](http://www.focusrite.com) and register your product. This will help us to monitor customer reaction and also enable us to mail you with future information.

In the event that you are dissatisfied in any way with the product, the supplying dealer or the service you receive, please write to me personally.

We are very interested in the successful use of our products and welcome tapes, comments and suggestions. If there is a product you wish we made, we'd love to hear about it.

In conclusion, I wish you success and hope you enjoy your Focusrite. Thanks for your custom.

Yours Sincerely

A handwritten signature in black ink, appearing to read 'Phil D', with a long horizontal flourish extending to the right.

Phil Dudderidge  
Chairman

# Accuracy & Warranty

Accuracy: Whilst every effort has been made to ensure the accuracy and contents of this manual,

Focusrite Audio Engineering Ltd makes no representations or warranties regarding the contents.

Copyright: Copyright May 1996 Focusrite Audio Engineering Ltd. All rights reserved. No part of this manual may be reproduced, photocopied, stored on a retrieval system, transmitted or passed to a third party by any means or in any form without the express prior consent of Focusrite Audio Engineering Ltd.

Warranty: All Focusrite products are covered by a warranty against manufacturing defects in material or craftsmanship for a period of one year from the date of purchase. Focusrite in the UK, or its authorised dealer worldwide will, at its own discretion, repair or replace any defective product. This warranty is in addition to your statutory rights.

This warranty does not cover any of the following:

- Carriage to and from the dealer or factory for inspection or warranty
- Consequential loss or damage, direct or indirect, of any kind, however caused

- Any damage or faults caused by abuse, negligence, improper operation, storage or maintenance

If a product is faulty please first contact your dealer in the country of purchase; as a last resort, contact the factory. If the product is to be shipped back, please ensure that it is packed correctly, preferably in the original packing materials. We will do our best to remedy the fault as quickly as possible.

Please help us by completing the registration form online at [www.focusrite.com](http://www.focusrite.com).

Thank you.

Focusrite Audio Engineering Ltd,  
19 Lincoln Road, Cresssex Business Park,  
HighWycombe, Bucks HP12 3FX, England

Phone: +44 1494 462246

Fax: +44 1494 459920

email: [sales@focusrite.com](mailto:sales@focusrite.com)

web: [www.focusrite.com](http://www.focusrite.com)

# Contents

## **Power Set Up** ..... page 4

- Power Supply
- Power Consumption
- Signal Connections

## **Red 1**

### **Four Channel Microphone Preamplifier** ..... page 5

- Controls
- Setting the Gain
- Setting the Phase
- Recording in Stereo

## **Red 3**

### **Compressor / Limiter** ..... page 6

- Compressor
- Dynamic Range
- The Controls
- Ratio
- Setting the Ratio
- Threshold
- Setting the Threshold
- Attack and Release
- Setting the Attack Rate
- Setting the Release Rate
- Make-up Gain
- Gain Change
- +14 dB
- Limiter
- Using the Key Input
- Compressing and Limiting a Stereo Signal
- Compensating for a Quiet Signal
- How to use Compression
- When to use Compression

## **Red 7**

### **Microphone preamplifier and Dynamics** ..... page 11

- Microphone Preamplifier
- Compressor
- De-Esser and Exciter
- Controls
- High-pass Filter

## **Red 8**

### **Two Channel Microphone Preamplifier** ..... page 12

### **Non Operation of All Modules** ..... page 13

### **Changing a Fuse** ..... page 13

## Power Connections

There is an IEC mains lead supplied in the package which should have the correct moulded plug for your country. The wiring colour code used in all Focusrite products is:

For units shipped to the USA, Canada, Taiwan and Japan:

**Live** - Black   **Neutral** - White   **Earth** - Green

For units shipped to any other country:

**Live** - Brown   **Neutral** - Blue   **Earth** - Green and Yellow

In all modules, the chassis is connected directly to the mains safety earth. We do not provide an earth lifting switch, since such a switch can allow for a dangerous wiring arrangement.

**Warning:** For safety reasons, it is absolutely **IMPERATIVE** that all modules have the mains safety earth connected.

## Power Supply

All modules will work correctly from either 50 Hz or 60 Hz power supplies.

Most modules will operate on a range of voltages, and have a two-position switch on the rear panel that should be set to the correct voltage:

**115V**   Set to this position if the module is to be used with voltages in the range 90V to 120V

**230V**   Set to this position if the module is to be used with voltages in the range 220V to 240V

To comply with the safety codes in some countries, modules may be supplied without a voltage selector. In this case, the module is preset to the local supply voltage, which is clearly marked on the rear of the module. Check that the voltage is set correctly.

## Power Consumption

The processing modules draw approximately 35VA from the mains supply at highest load.

## Signal Connections

All the signal connections are via connectors mounted on the rear panel. Standard XLR connectors are used for all mic and line level signals, and are wired to the AES standards, which are:

|              |        |            |
|--------------|--------|------------|
| <b>Pin 1</b> | Screen | chassis    |
| <b>Pin 2</b> | Live   | audio 0°   |
| <b>Pin 3</b> | Return | audio 180° |

On every module except for the Red 3 and Red 5, all inputs and outputs are transformer coupled. (The Red 3 is transformer coupled on the outputs but not at the inputs, and the Red 5 has no transformer coupling.) Transformer coupling creates a complete electrical barrier between all the internal circuitry and power supply and the outside world, and so removes the possibility of ground loops. It is designed for balanced connections: if you want to make unbalanced connections, you must connect pins 1 and 3 of the XLR together, as shown in the diagram.

For all inputs and outputs, the screen (pin 1 of the XLR) is connected to the chassis earth point. When the screen and earth wiring of the module is completed correctly, all modules which are marked with the European Community CE marking comply fully with the relevant EMC regulations.

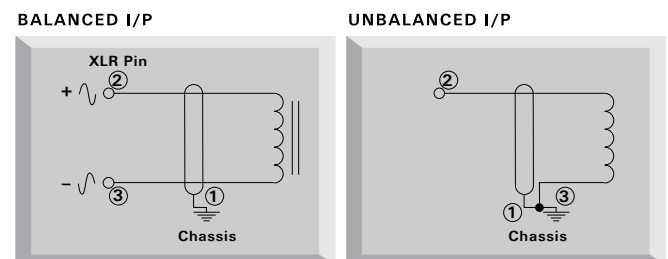

# Red 1

## four channel microphone preamplifier

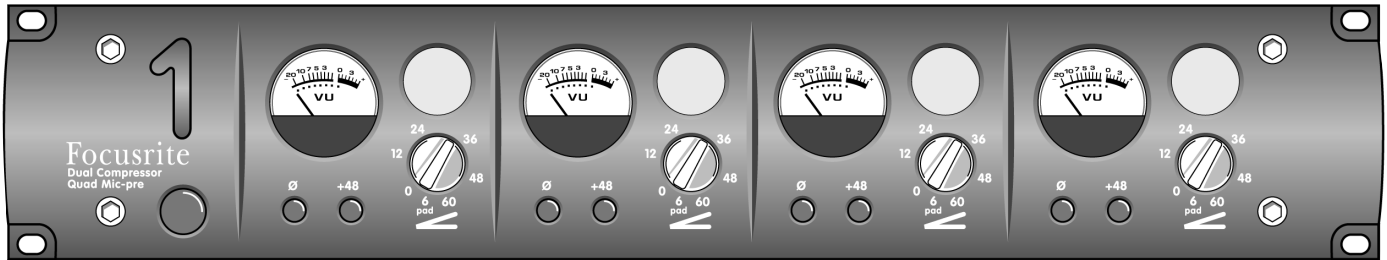

The Red 1 provides four independent microphone preamplifiers, each available as a separate channel.

The design of the Red 1 also allows it to be used for stereo recording - see the section *Recording in Stereo*.

### Controls

Each of the four channels on the Red 1 is identical, and has the controls shown in the diagram.

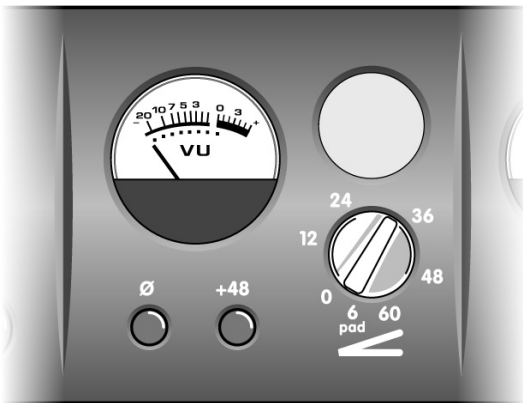

The gain control is switched, and has 12 positions. The first position gives -6 dB gain, in other words it attenuates (reduces the volume of) the signal, and is for use with microphones that have very high output levels. Each subsequent position increases the gain by 6 dB, up to a maximum of 60 dB.

Ø is the phase button, and reverses the phase of the channel when lit.

+48 is the phantom power button. When lit, it provides phantom power to the microphone connected to the channel.

### Setting the Gain

Use the meter and gain control to match the incoming level and gain to the internal operating level. With an input signal coming into the channel, watch the meter as you use the gain control to modify the gain, and set the gain control so that the meter registers between -4 VU and 0 VU. This sets the level to give the maximum signal to noise ratio, whilst leaving room for any sudden increase in performance level (it gives about 20 dB of usable headroom).

### Setting the Phase

When recording a single source using more than one microphone then you need to ensure that you do not put your two close microphones out of phase with the ambient microphone.

If you think two signals are out of phase, listen for phase as follows:

1. On your monitor system, pan one signal to the left and the other to the right.
2. Use the phase switch to reverse the phase on one of the signals. When the two signals are in phase, the signal sounds bigger

### Recording in Stereo

Since the gain controls on the Red 1 are switched, accuracy between channels is very closely matched. When recording with a matched pair of stereo microphones, put them through separate channels of the Red 1 and set the gain controls for both channels to the same position.

# Red 3

## compressor/limiter

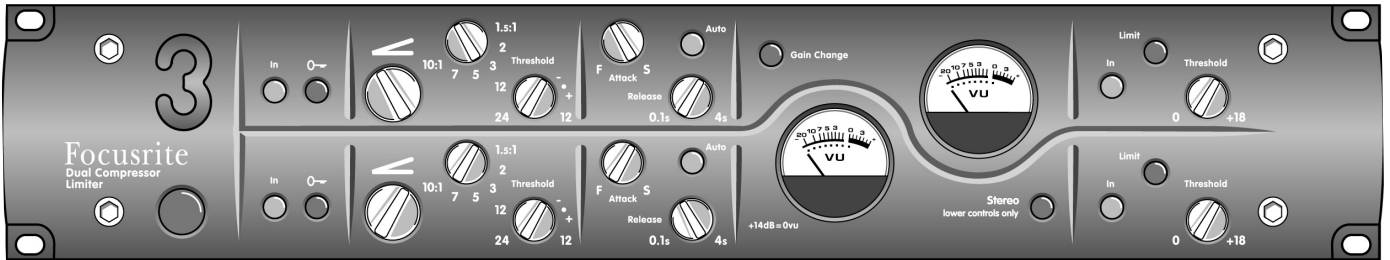

**The Red 3 is a 2-channel compressor and limiter. Each channel can operate independently on two mono signals, or they can be combined to act as a single compressor and limiter on a stereo signal.**

Compressors and limiters both act like automatic volume controls, turning down the volume of a signal if it gets too loud. The difference between the two is:

- A limiter sets an upper limit on the volume, and will not allow the signal to go above that volume

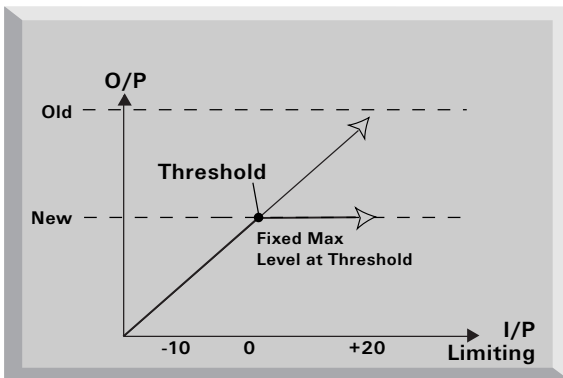

- A compressor reduces changes in volume, so that the dynamic range of the compressed signal is lower than the dynamic range of the input signal

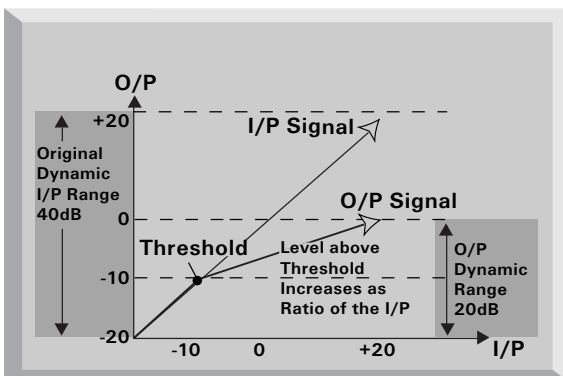

When you are getting to know the unit, particularly if you are not familiar with using a compressor, use it on a track that you are familiar with (for example, you could run a favourite CD through the unit). Try all of the controls in turn, and hear how they affect the sound. Working with a familiar track makes interpretation of the results easier. Note, however, that tracks are already compressed for CD, so you may find it hard to hear the results easily. If this is the case, try using samples instead (if you have access to them), or record your own track uncompressed and then play it back through the Red 3.

There are two separate parts to the Red 3:

- The Compressor
- The Limiter

### Compressor

A compressor reduces the dynamic range of a signal by automatically reducing the gain when it gets louder than a certain threshold. To understand a compressor, you must understand dynamic range - if you do not, you should read the following section about dynamic range.

Note that compression tends to even out a performance (particularly of stringed instruments such as guitar) since it stops the instrument getting very loud or very quiet in the mix. When compressing hard, it also reduces an instrument's attack (again, this is most noticeable with stringed instruments).

### Dynamic Range

The dynamic range of a signal is the difference in volume between the quietest and loudest parts: for music, the dynamic range can be as wide as 120 dB.

Signals with wide dynamic range demand greater attention from the listener, and require listening conditions with low background noise. Consequently, in areas with high background noise, such as a restaurant, it is hard to listen to signals with a wide dynamic range - only the loud parts are heard, with the quiet parts being lost in the ambient noise. Compressing the signal reduces the dynamic range and so makes it easier to hear in such situations.

Similarly, the dynamic range of the signal can exceed that of the medium used to carry it:

- 16-bit digital recordings (such as DAT) have a theoretical maximum dynamic range of 96 dB. It is essential that you do not exceed this limit
- Analogue tape has a dynamic range in the order of 60 dB (though noise reduction can add between 15 and 30 dB). It is not always necessary to limit dynamic range when recording onto analogue tape, as the tape saturates naturally when recording loud signals, which in some cases can be useful
- FM radio has a dynamic range of 40 to 50 dB
- AM radio has a dynamic range of 20 to 30 dB

In all of these cases, you can use a compressor to restrict the dynamic range of the signal to that of the medium.

### The Controls

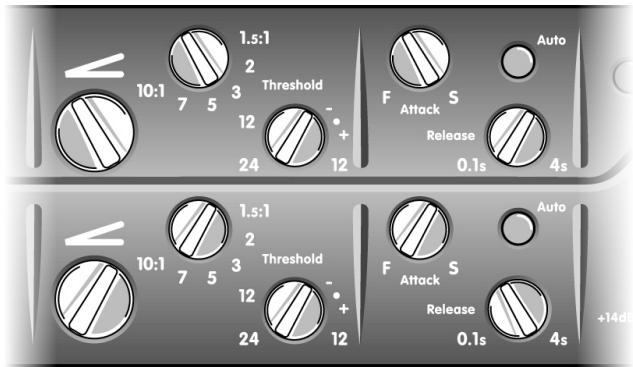

- The ratio and threshold controls set the amount of compression applied to the signal
- The attack and release controls set the duration of the compression
- The make-up gain sets the output volume of the compressed signal.

### Ratio

The ratio control determines how much compression is applied to the signal. The ratio (such as 2:1) refers to the ratio of change in input level to the change in output level. So, a ratio of 2:1 means that for every 2 dB change in the input level, the output level changes by 1 dB, as shown in the following diagram:

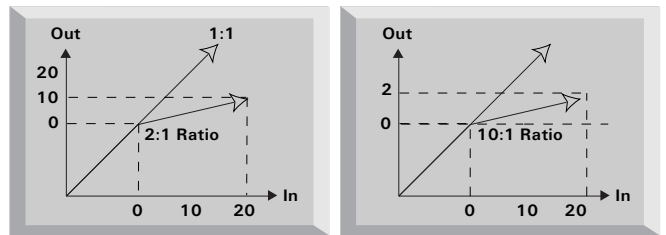

### Setting the Ratio

As you increase the ratio, the sound becomes tighter and the effect of the compression becomes more noticeable. A lower ratio has a softer slope, which preserves more of the original dynamic range, since an increase in input level still results in a significant increase in output level.

### Threshold

The threshold determines when the compressor starts to compress the signal. By setting a threshold, you do not compress all of the input signal - instead, you compress the signal only when it is louder than the threshold, as shown in the following diagram:

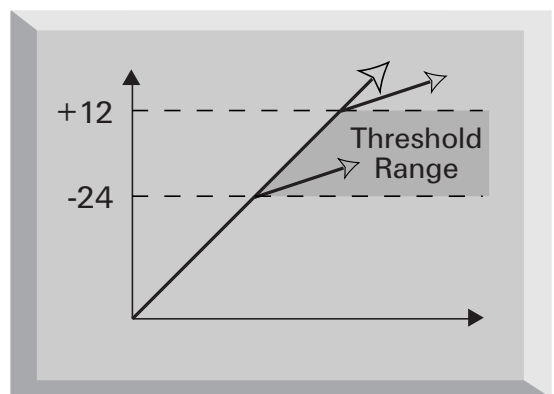

### Setting the Threshold

By setting a threshold, you determine that quieter passages maintain their natural dynamic range, and only loud passages (that go above the threshold) are compressed.



### Attack and Release

The attack and release controls determine how quickly the compressor switches on and off at the threshold. Without an attack control, full compression would be applied to the signal as soon as it got louder than the threshold. Similarly, without a release control, the compressor would switch off as soon as the signal got quieter than the threshold. While this is fine in some recording situations, in most it gives an unnatural sound to the signal, so you can use the attack and release controls to modify this.

Note that the optimum attack and release rates vary with the instrument being recorded, and with the performance. For example, when recording a snare drum, a fast attack and release are needed - a slow release over-compresses the signal, with all beats after the first dulled slightly because the compressor is still on.

### Setting the Attack Rate

By slowing the attack rate, the compressor gradually comes to full compression, instead of compressing immediately.

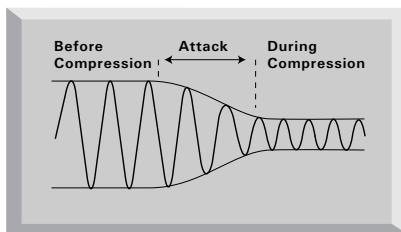

Transient response is less affected, so maintaining the presence of each note.

Attack times do not need to be very fast when recording onto analogue tape - you can use slower attack times of around 1 ms. The fastest transients are lost by saturation of the tape and become inaudible, and longer duration peaks can be controlled by the compressor, giving a more natural sound.

### Setting the Release Rate

By slowing the release rate, the compressor recovers more slowly from compression, so it does not turn off completely when the signal returns below the threshold.

The release rate is probably the most important variable when recording rock music, since it controls loudness.

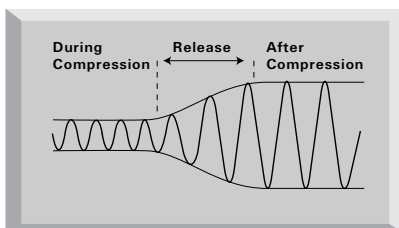

Loudness is determined by the maintenance of high mean levels: compression increases the proportion of high-level signal content, and as the diagram shows, the faster the unit releases, the more low-level signal is brought to a higher level. Therefore, the faster the release rate, the higher the perceived loudness of the recording.

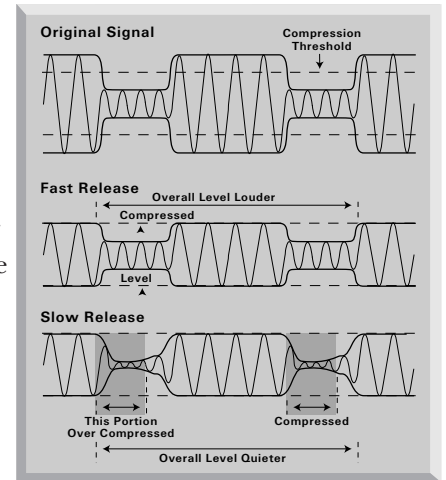

You do not have to set a permanent release time for the whole input signal; instead, you can use the Auto button. Auto reacts to the dynamic range of the input, so the higher the signal is above the threshold, the longer the release. This means that fast signals that aren't compressed hard have a fast release time, while longer signals release more slowly, which makes the compression in context with the signal.

### Make-up Gain

Compressing a signal makes it quieter. After you have set the compression on the signal, use the make-up gain to restore the signal's original volume.

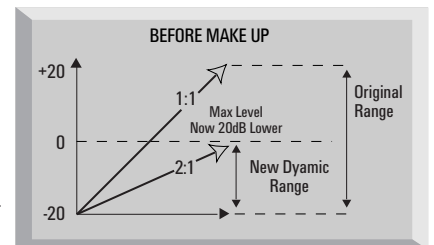

For example, in the diagram the compressor reduces the signal by 20 dB, which reduces the dynamic range of the input and in so doing makes the signal quieter.

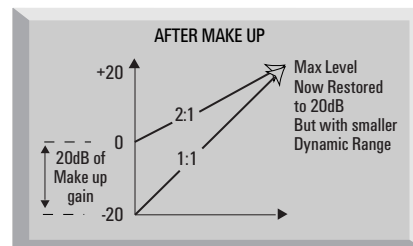

Using the make-up gain restores the volume of the compressed signal.

### Gain Change

This modifies what the meter displays. When the switch is out, the meter displays the level of the input signal. When the switch is in, the meter displays the amount of compression. Since compression reduces the volume of the signal, the meter drops as compression is applied. For example, a 3 dB drop shows as -3 VU on the meter.

+14 dB

This switch affects the input-level meter:

- When it is out, a signal of +4 dB registers as 0 VU
- When it is lit, a signal of +14 dB registers as 0 VU

The switch lets you monitor very loud signals without overloading the meters (for example, if the incoming signal is very loud).

### Limiter

The limiter sets an absolute threshold for the signal volume after compression, and does not allow the volume to go above that threshold.

Note that the threshold for the limiter is independent of the threshold for the compressor (the dB value of the limiter's threshold is an absolute value, not a relative value above the compressor's threshold). Therefore, it is possible to set the threshold for the limiter below the threshold for the compressor - if you do this, the limiter will not work.

When the limiter is working, the limit light comes on.

### Using the Key Input

Pressing the key input button switches control of the compressor to a signal entering the unit through the

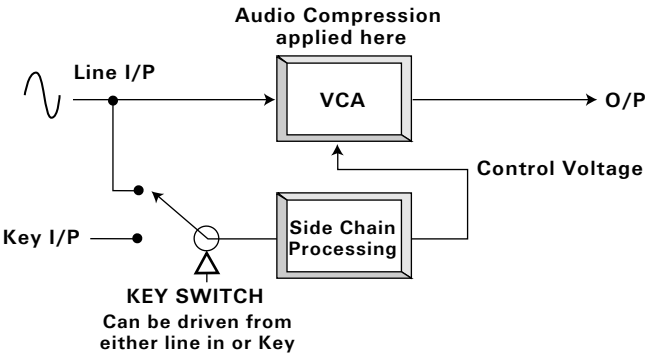

key input. Note that the key input signal is not output from the unit, it is the original input that is compressed, but compression is applied as if the key input signal were being compressed.

For example, one of the problems in compressing a mixed programme is that gain reduction tends to be controlled by one dominant instrument or sound. For more natural compression, you need to attenuate (reduce the volume of) the sound of the dominant instrument, but this is probably not acceptable since it would affect the mix. Therefore, you can use the key input: take a second feed of the programme, and feed it through an equaliser that attenuates the dominant instrument, then take that signal and feed it into the key input, as shown in the diagram.

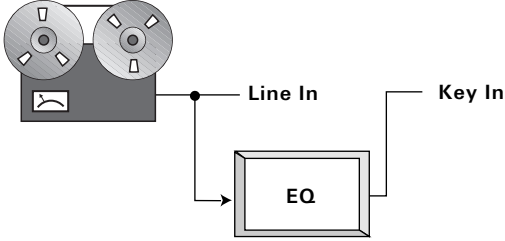

Now, you can use the key input to control the compression of the original signal. The original signal is compressed as if the dominant instrument had been attenuated.

This technique can be very useful when compressing bass-heavy dance music. By attenuating the bass in the key input signal, the bass in the original retains more of its dynamics.

Another application of this technique is in de-essing. When de-essing, you want sibilants in a voice to be heavily compressed. To achieve this, accentuate the sibilants in the key input signal by adding gain to the correct frequencies, which means they are heavily compressed in the original signal.

### Compressing and Limiting a Stereo Signal

Normally the two channels of the Red 3 run independently in mono. Controlling a stereo signal using two independent channels is very difficult, since it is almost impossible to set the controls for both channels identically. If the channels are not compressed identically, you will compress one channel more than the other, thus shifting the stereo position to the left or the right. To avoid this problem, use the stereo button. This disables the top controls: the bottom controls determine the compression applied to both channels.

### Compensating for a Quiet Signal

On some consoles, the insert sends are at lower than standard operating levels. You will perceive this as an increase in the overall noise of the unit, since the signal level of the input is close to the noise floor of the unit. To compensate for this, there is a switch on the rear panel of the module, marked as 0 dB and -6 dB. To change the input gain, and improve the signal to noise ratio of the unit, set this switch to the 0dB setting.

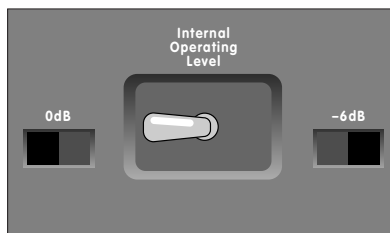

### How to Use Compression

- Using an input signal with wide dynamic range, set the controls in the following starting positions:
  - Ratio in the middle (around 5:1)
  - Threshold at maximum (+12)
  - Attack and release at their fastest
  - Make-up gain at minimum
  - Switch the meter to show gain change, so that you can monitor the effect of compression
- Reduce the threshold, and monitor the effect this has on the sound:

- Listen to the reduction in the dynamic range
- Watch the meter to see the amount of gain reduction

As you reduce the threshold, increase the make-up gain to restore the level of the signal

- When you are close to the dynamic range you want, you need to adjust all the controls to achieve the quality of sound that you are looking for:

- Adjust the ratio to compress softer or harder
- Adjust the threshold to compress sooner or later

The combination of ratio and threshold determines the maximum level of the loudest sections.

- Adjust the attack to dampen the sound or to restore transients
- Adjust the release to even out compression between the loud and quiet sections

The release determines the level of the quietest signal.

The combination of ratio, threshold and release determines the overall dynamic range.

### When to Use Compression

Compress hard:

- To stop dropping in and out (particularly vocals - compress quite hard so they sit above the mix).
- When recording bass (for example) - there is a lot of bass energy that can easily get out of control
- When recording snare
- Anything you want to maintain a continuous presence in the mix

Compress more softly:

- When the attack is an important characteristic of the sound

When compressing softly, set the limiter to the maximum input level of the next stage in the signalchain. This lets you compress softly without the risk of overloading the next stage.

# Red 7

## microphone preamplifier and dynamics

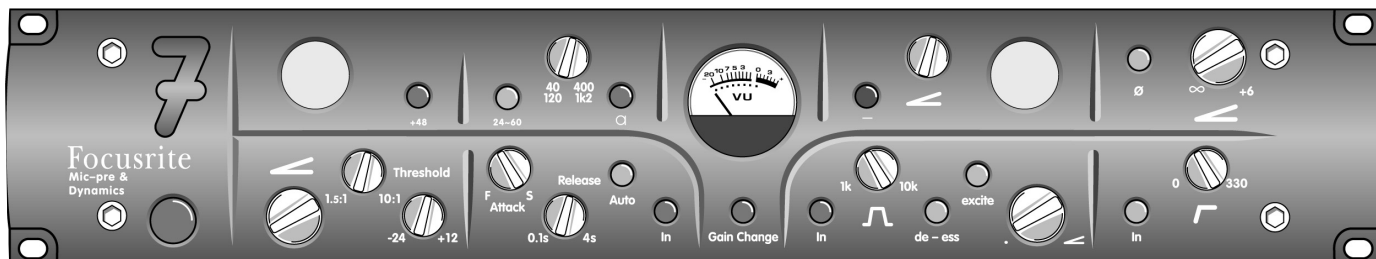

**The Red 7 is a combined microphone preamplifier and compressor/de-esser. As with the Red 6, the inclusion of the microphone preamplifier in the Red 7 makes it an excellent recording tool, since it can accept mic level input (from microphones and low output instruments) in addition to line level input (such as from a tape machine or high output instrument).**

Instead of using a channel on a mixing desk when recording from a microphone, you can use the Red 7 to record direct to a track on tape, monitoring using the tape return from the tape machine. This ensures the highest quality signal onto tape, since it removes unwanted elements from the signal chain and so reduces the amount of noise added to the signal.

There are four separate parts to the Red 7:

- Microphone preamplifier • Compressor
- De-esser and Exciter • High-pass filter

### Microphone Preamplifier

The microphone preamplifier has all the features of a single channel of a Red 1, with the following additions:

- You can switch between mic and line level inputs using the switches on either side of the meter. The red switch to the left of the meter activates the mic level input, and allows you to use the mic gain control next to it. The green switch to the right of the meter activates the line level input, and allows you to use the line level gain control

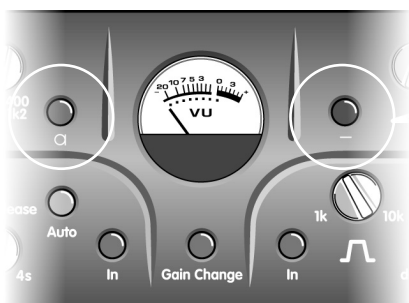

- The gain switch for the microphone input (labelled 24 - 60) modifies the amount of gain available with the gain control. When the gain switch is not lit, you can add between -6 dB and +24 dB gain to the input signal; when the switch is lit, you can add between 24 dB and 60 dB gain.
- The gain control at the right hand end of the module in a final fader level output. This lets you trim the output level of the Red 6 to match the input level of the next device.

If you need information on how to use any of the other features of the microphone preamplifier, refer to the section on the Red 1 earlier in this guide.

### Compressor

The compressor has all the features of a single channel of a Red 3. If you need information on how to use the compressor, refer to the section on the Red 3 earlier in this guide.

### De-esser and Exciter

The de-esser lets you remove excessive sibilance from a vocal performance, by selecting the frequency range that contains the sibilants and heavily compressing when the frequency range exceeds the threshold.

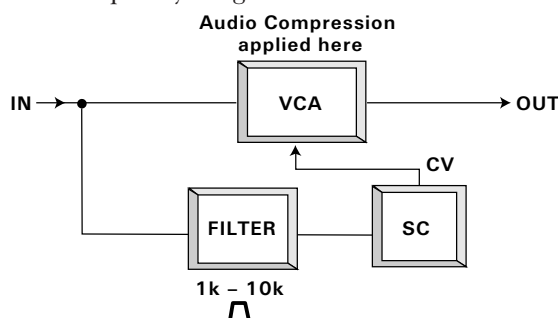

The exciter is the opposite of the de-esser - it amplifies the selected area of the frequency spectrum. It is good for resurrecting an old recording, or for restoring the dynamic range of an instrument, so putting life back into it and letting it sit higher in the mix.

### Controls

$\Lambda$  controls a band pass filter, which is a combination of high- and low-pass filters on a single control. As this

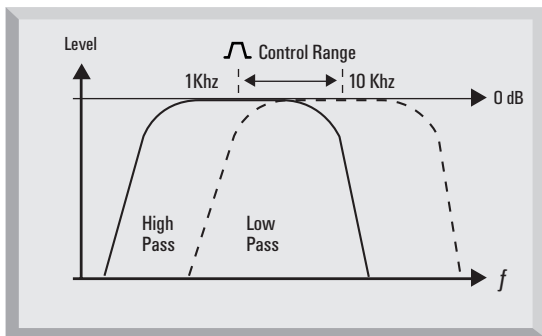

control is adjusted, both filters change in unison, blocking the high and low signals so that only a narrow band of frequencies can pass between them.

Moving the control isolates different small parts of the frequency spectrum. Move the control until you start compressing the frequency range containing the sibilance, or start amplifying the frequency range you want to restore with the exciter.

### High-pass Filter

The high-pass filter is provided to remove rumble and bass lift on microphones, since the Red 7 is designed so that it can be the only item in the signal chain between a microphone and the tape machine.

For more information on a using high-pass filter, see the section on the Red 2 earlier in this guide.

# Red 8

## two channel microphone preamplifier

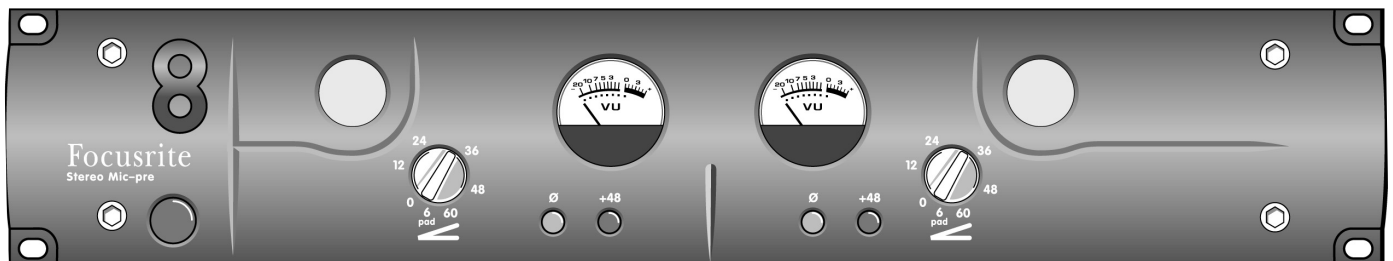

**The Red 8 provides two independent microphone preamplifiers, as two separate channels.**

In use, the Red 8 is identical to the Red 1, so if you need information on how to use any of its features, refer to the section on the Red 1 earlier in this guide.

# Non Operation of All Modules

## Non-Operation of All Modules

**Warning: Do not attempt to fix a Red 5 Power Amplifier - contact your dealer or the factory.**

- If none of the LEDs light, check the mains supply:
  1. If the module connected to the mains supply?
  2. Is the socket switched off?
  3. Is the voltage select switch on the back of the unit in the correct position?
  4. Have you switched the module on?
  5. If the supply is okay and the module turned on but no LEDs light, then a fuse has probably blown. See the section on changing a fuse

- If some LEDs light but the unit does not work properly, check the LEDs:
  - The mains switch LED will only light if the  $\pm 15V$  rails are okay
  - The small switch LEDs will only light if the +5V rail is okay
  - The phantom switch LED will only light if the +48V rail is okay

These LEDs will allow you to see if a power rail has failed. If a power rail has failed, contact your dealer or the factory.

## Changing a fuse

**In most modules there are two fuses inside the module on the supply side of the transformer. These fuses are ALWAYS 250 mA anti-surge type: the fuse value does NOT change when the mains voltage selector switch is changed, since we fuse each winding separately.**

We strongly recommend that you do NOT attempt to change fuses unless you are absolutely certain that you know exactly what you are doing. If you are in any doubt whatsoever, contact your dealer or the factory before you open the module.

Warning: Do not attempt to investigate fuse failure in a Red 5 Power Amplifier without first consulting your dealer or the factory. The fuses in a power amplifier are the safety device of last resort - all normal mishaps should trigger shutdown and not blow the fuse. A fuse failure is serious and almost certainly indicates a major problem.

To change a fuse in a Red module other than a power amplifier, if you are certain of your technical ability:

1. Disconnect the mains cable
2. Viewing the module from the front, remove the hex bolts that secure the left-hand panel. These bolts are located on the front and rear panels

3. Carefully remove the left-hand panel, disconnecting the earthing lead from the chassis by removing the spade connector
4. Slightly loosen the hex bolts that secure the right-hand panel. This allows the top cover to slide out
5. Remove the top cover, disconnecting the earthing lead from the chassis by removing the spade connector
6. The fuses are in holders to the rear of the transformer. By shining a torch onto the fuse holders, you should be able to see which fuse has blown. To remove the fuse, pull off the top of the fuse holder, which holds the fuse
7. When you have replaced the fuse, slide the top cover back into position and check that the bottom cover is also in position
8. Reconnect the earth lead to the top cover and left-hand panel, and also check the earth lead connection for the bottom cover
9. Replace the left-hand panel and secure it with the four hex bolts





## Focusrite Audio Engineering Ltd

Lincoln Road, Cressex Business Park, High Wycombe, Bucks HP12 3FX England  
Phone: +44(0)1494 462246 email: [sales@focusrite.com](mailto:sales@focusrite.com) Website: [www.focusrite.com](http://www.focusrite.com)